

enabling the future of science

BOROSIL[®] Scientific

Borosil Scientific Limited

MANUFACTURERS OF

LABORATORY GLASSWARE
LABORATORY INSTRUMENTS
ANALYTICAL VIALS
PROCESS SYSTEMS
PHARMACEUTICAL PACKAGING

PRODUCT CATALOGUE

PROUDLY MADE IN  india

PRICE LIST 2025-26

1st APRIL 2025

Distributor: CT Enterprises

Please contact CT Enterprises for
quotation.

Email: sales@ctenterprises.in

Phone: +91 8977721310



BOROSIL[®]
enabling the future of science

**BOROSIL
KLASSPACK[®]**
pharmaceutical packaging

**LABQUEST
BY BOROSIL[®]**

BOROSIL[®]
PROCESS SCIENCES

goal[®]
The Transparent Specialist
A BOROSIL Scientific Company

MISSION & VISION

Our mission is to emerge as the preferred vendor for laboratory glassware and to develop a complementary range of products for the laboratory.

To enjoy this fascinating journey while enhancing marketing capabilities, continuously improving our quality and services and investing in our people while being socially responsible and yielding profits for our stakeholders.

Please contact CT Enterprises for quotation.

Email: sales@ctenterprises.in | Phone: +91 8977721310



Leading by Vision

Message from our MD and CEO

Shreevar Kheruka

Managing Director & CEO

Borosil Limited



At Borosil Scientific, our journey has always been guided by a deep-rooted desire to satisfy our customer. We have spent decades building trust, delivering world-class solutions, and empowering professionals across industries. This relentless pursuit of progress is what drives us forward.

India stands at a defining moment in its growth trajectory, with science and technology playing a crucial role in shaping its future. As industries evolve, the need for high-quality, reliable, and efficient solutions has never been greater. We recognize this responsibility and remain steadfast in our mission to support the scientific community with tools that enable discovery, efficiency, and transformation.

Our ability to adapt, innovate, and stay ahead of the curve is what makes Borosil a trusted name. As we look ahead, we remain dedicated to expanding our horizons in the laboratory to include a wider range of equipment for testing and analysis as well as for research and development. We are proud that our innovation is driven by a young and enthusiastic workforce that are proud to develop new ideas and make in India.

I extend my sincere gratitude to our customers, partners, and team members whose trust and collaboration continue to propel us forward.

Corporate Values



Integrity

- We conduct our business sincerely and fairly, with honesty and transparency
- We hold ourselves to the same high standards we set for others
- We uphold the values of Borosil in every action and decision
- We abide by the highest standards of ethics in all our financial dealings regardless of the amounts involved
- We stick to our values even in the most difficult of circumstances
- Judgement & decisions are taken on the basis of facts & figures not based on perception



Customer Focus

- Our customer (external as well as internal) is at the center of our actions
- We build long term relations with our customers
- We focus our attention on those activities that bring value addition to our customers
- We strive to understand our customers' needs proactively and meet these needs on time
- We provide value for money to our customers



Respect

- We give honest and constructive feedback to help people achieve their full potential
- We are on time and prepared for our appointments and meetings
- We treat/ deal with every individual with utmost dignity, empathy and professionally
- We encourage team work and never hesitate to give credit to others
- We actively & empathetically listen to others and respect their views, irrespective of their levels and / or other abilities
- Our decisions are always neutral & data based and not person based



Continual Improvement

- We believe in continuous quality improvements in our products and processes through innovation and team work
- We strive to understand internal and external benchmarks and improvise to reach them
- We challenge accepted ways of doing things and suggest new approaches
- We make efforts to understand new trends in the market place and introduce innovative products / services to capture these trends
- We are committed to learning and bringing new ideas to the table



Accountability

- We take ownership of our decisions and hold ourselves accountable for both successes and failures
- We find alternative paths to success rather than waiting for direction
- We speak up even if it is not the majority view
- We do what is best for the company rather than function or for self
- We focus on outcomes and results rather than activity
- We fulfill all commitments made to colleagues and customers



Safety

- We value human life and our bodies more than profits
- We

Please contact CT Enterprises for quotation.

Email: sales@ctenterprises.in | Phone: +91 8977721310

property

The **BOROSIL** Group

Science & Industrial Products Division



Borosil's Scientific Limited offers an entire gamut of the finest quality scientific and laboratory glassware, laboratory instruments and primary pharmaceutical packaging. Borosil Technologies Limited located at Hinjewadi, Pune is a 100% owned subsidiary of Borosil Limited which is mandated to develop Laboratory equipments under Labquest brand. Borosil Klass Pack Ltd., a subsidiary of Borosil Limited, is one of India's leading manufacturers of Glass Ampoules and Tubular Glass Vials of USP Type 1 that are widely used as primary packaging materials by pharmaceutical companies for their life-saving drugs. We also manufacture a wide portfolio of Chromatography vials. Borosil Process Sciences, a recent introduction in the portfolio provides sophisticated offerings for chemical synthesis & process development from bench top reactors to complex pilot plants with programmable controls. This range of over 3000 products from glassware, equipment and pharma packaging finds application across diverse disciplines such as Quality Control in pharmaceutical industries, research institutes, food and soil testing, microbiology, biotechnology, agriculture and many more. Newest introduction Symbolising quality, accuracy and dependability since six decades, Borosil has earned the trust and unwavering loyalty of leading pharmaceutical companies and R&D laboratories, as well as scientific, health and educational institutions.

Consumer Division



For over half a century, Borosil has stood as the premier brand for heat-resistant glassware in India, epitomizing quality and durability. Recognized as the trusted choice among consumers nationwide, Borosil represents much more than just glassware. The brand has broadened its portfolio to include Larah Opal Glass dinner sets, kitchen appliances, Insulated Flasks & bottles, Cookware and pressure cookers, storage solutions, and even glass lunch boxes, that resonate to the everyday needs of today's consumers.

Borosil's expansion into small appliances has been particularly noteworthy. The brand now offers a wide array of products including Juicer Mixer Grinders, Hand Mixers, Oven Toaster Grills, Toasters, Blenders, and Rice Cookers. Each appliance is supported by Borosil's extensive nationwide customer service network, ensuring that help is always within reach, minimizing any inconvenience.

At Borosil, the pillars of quality and trust are paramount. We are dedicated to going above and beyond to ensure that our products not only meet but exceed expectations, performing beautifully across all uses. Explore our comprehensive product range at www.myborosil.com and discover how we can make every day better for you.

Solar Division



Borosil Renewables Ltd. is the first solar glass manufacturer in India and is part of the 'Borosil Group, which has been engaged in manufacturing a wide range of consumer-ware products and scientific and laboratory glassware for over five decades. Our state-of-the-art manufacturing facility is spread over around 100 acres in Bharuch, Gujarat, with a solar glass production and processing capacity of 1000 TPD, equivalent to 6.5 GW per annum. Recently, Borosil Renewables Ltd. acquired Europe's largest manufacturer of solar glass, the Interfloat Group, which consists of Glass Manufacturing Brandenburg (GMB), located in Tschernitz, Germany, and Interfloat Corporation, based in Liechtenstein. GMB operates a solar glass plant with a production capacity of 350 TPD (tonnes per day). With this acquisition, BRL's solar glass capacity has grown to 1350 TPD. The company has a strong focus on innovation and is known for its pioneering achievements like the development of the World's First fully tempered 2 MM thick solar glass, solar glass with the lowest iron content, giving the highest glass efficiency, and being the first company in the World to successfully be able to remove an extremely hazardous substance, "antimony," from its solar glass, etc. The company has products like Selene, an anti-glare solar glass suitable for PV installations near airports, and Shakti, a very high-efficiency solar glass in a matt-matt finish.

BOROSIL[®] **Scientific** Quality Policy

We, at Borosil Scientific Limited, are committed to understanding our customer's needs and fulfilling the same on time every time.

By bringing the voice of our customers inside the organization, we strive to be our customers' #1 preferred brand.

We are committed to achieving the highest level of customer satisfaction through improvements in quality of our products & services.

We believe in continual improvements and innovation in our business and manufacturing processes. We strive to ensure that our team achieves the highest quality output in the most efficient manner possible.

This will be achieved by our total commitment to:

- Communication with our customers to understand their needs
- Continuously updating our technical competence, systems and processes
- Enhancing the expertise of our people by periodic training & reviews
- Preserving our corporate values

This policy will be available to all interested parties where appropriate.

Date: 01.01.2024

Vinayak Patankar
Whole time Director & Chief Executive Officer

Leading by Vision

Message from our CEO



Vinayak Patankar

Whole Time Director & Chief Executive Officer

Borosil Scientific Limited

At Borosil Scientific, we believe that progress in science begins with the right tools. Whether in research labs, manufacturing facilities, or quality control centers, our goal is to empower professionals with solutions that enhance efficiency, precision, and reliability.

This year, our focus is sharper than ever—on simplifying workflows, enhancing user experience, and ensuring the best customer support. Science is complex, but the tools that drive it shouldn't be. With a vision rooted in customer satisfaction, we aim to continually evolve with your needs, optimizing from conventional methods, simplifying complexity, and solidifying outcomes.

As times advance, we believe that every step forward should bring greater ease and efficiency. With a global outlook, we are focused on creating lasting value for industries worldwide. We remain committed to anticipating challenges and providing solutions that truly make a difference. Here's to another year of discovery, innovation, and shared success.

A Legacy of more than 6 decades...

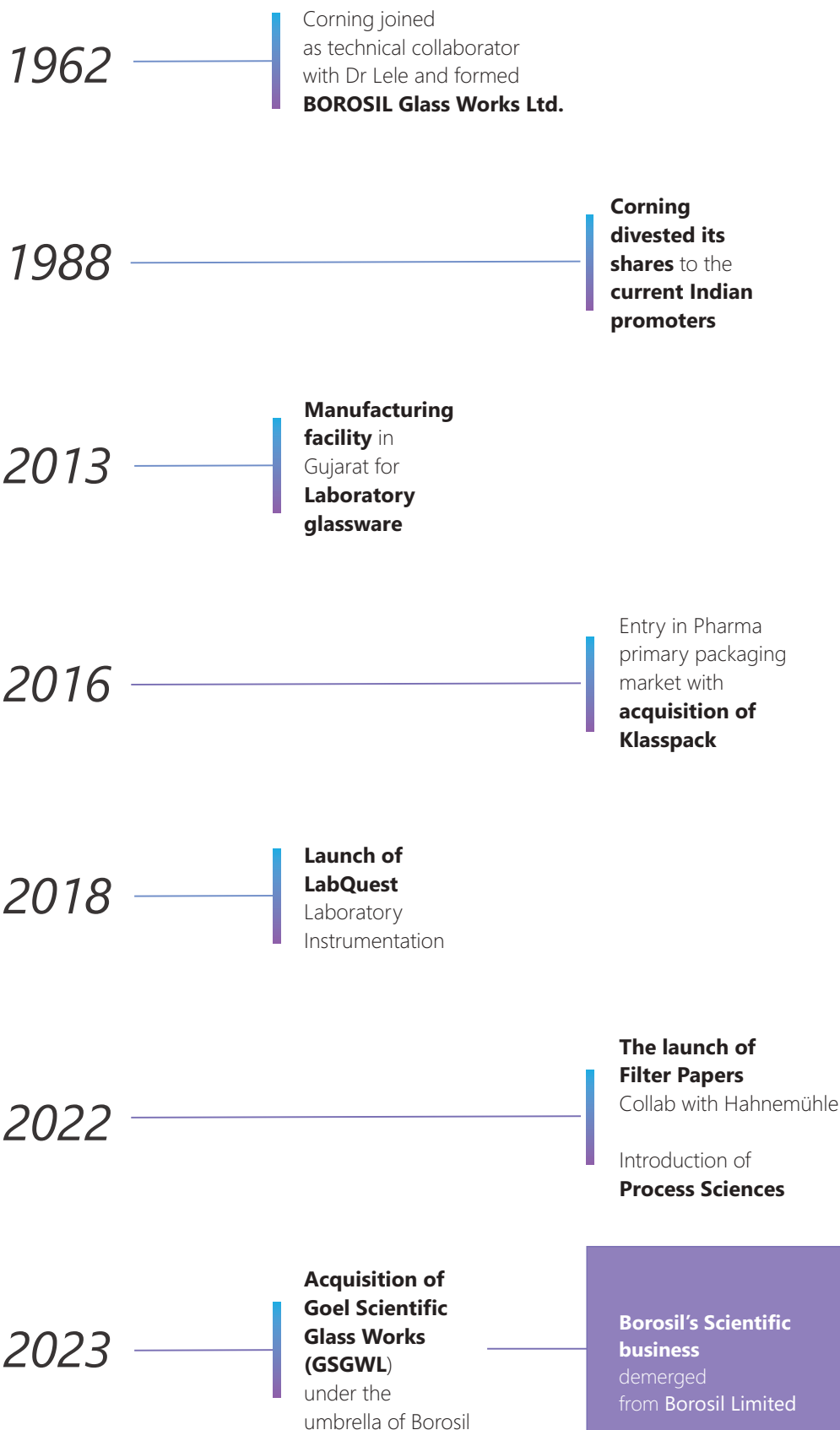

Please contact CT Enterprises for quotation.

Email: sales@ctenterprises.in | Phone: +91 8977721310

About us

BOROSIL® Scientific

Borosil Scientific Limited



In Dec 2023, the scientific business of Borosil Ltd demerged to form Borosil Scientific Limited which now comprises Laboratory instrumentation, Pharmaceutical Primary packaging, Process systems, in addition to the laboratory glassware and consumables.

Our Purpose

We are driven by the belief that science holds the key to progress. As a homegrown manufacturer from India our mission is to empower the scientific community by developing superior quality products that are safe, dependable and yet affordable.

By making the best scientific tools which are accessible to all laboratories in India and across the globe, we are making a sincere effort to contribute to the growth of industries and, in turn, build a self-reliant nation where collective progress thrives.

60+

Years of experience

4000+

SKUs spanning over 4 verticals

5

Manufacturing locations in India

4

Warehouses PAN India

150+

Channel partners PAN India

Envisioning Our Way Ahead



Vision

As torchbearers of India's scientific legacy and in the pursuit of a nation built on scientific temper, our vision is to make science accessible to all.



Mission

Borosil Scientific serves as the channel linking scientific exploration and industry demands. Our mission is to provide reliable and intelligent solutions.



Purpose

Being an Indian manufacturer our purpose is to develop safe & quality products which are accessible to all scientific industries in India and across the globe

As we enter the new year with great enthusiasm, it is also a time to reflect and plan our path towards envisioned business objectives which includes being your partner for all laboratory requirements. With that in mind, we would like to share some thoughts with you.

The laboratory equipment market is experiencing significant growth, driven by increasing demand for healthcare services, the expanding pharmaceutical industry, and various government initiatives. The Indian market, in particular, has benefited immensely from the "Make in India" initiative. The "China Plus One" strategy has further bolstered the position of Indian manufacturers. This has also contributed to a rise in export-oriented growth for Indian companies. Moreover, government initiatives aimed at enhancing healthcare infrastructure and fostering research play a pivotal role in fueling the demand for laboratory equipment, making it an exciting time for the Indian laboratory equipment industry.

In this landscape, Borosil Scientific has consistently proven to be a trusted partner in a wide range of industries, from pharmaceuticals to food and agriculture, committed to providing integrated, innovative solutions that drive success for our customers through value in service, value in quality, value in performance, and most importantly, value in the experience we offer our customers. Borosil Scientific stands as a trusted leader, renowned for our comprehensive product range—spanning over 4,000 laboratory solutions, including scientific glassware, analytical vials, laboratory equipment, and primary pharmaceutical glass packaging.

Please contact CT Enterprises for quotation.

Email: sales@ctenterprises.in | Phone: +91 8977721310

Our manufacturing facilities across 4 strategic locations



Through our operations at our **Bharuch facility**, we lead the Indian market for laboratory glassware, continuously setting new benchmarks for durability and accuracy. Our commitment to innovation has driven the introduction of advanced features like Laser Marking, QR-coded glassware, instant access to certificates, and improved meniscus reading on Class A Glassware certificates.

Our **Pune facility** produces a diverse array of Laboratory Instruments and Process Science Equipment that provide industrial clients with international-quality products at competitive price points, offering genuine value for laboratory needs. Our 'Labquest' brand is synonymous with reliability, meeting both national and international standards, and reinforcing our legacy of excellence. Our advanced process systems and lab equipment cater to the chemical and petrochemical industries, enabling high-precision research and development

Our **Nashik facility** is recognized for our expertise in critical sectors, particularly pharmaceuticals, where our Glass Ampoules and Tubular Glass Vials made from USP Type 1 glass serve as vital primary packaging materials for injectables and also chromatography vials.

The recent acquisition of **Goel Scientific** (Baroda) enhances our capabilities in process chemistry automation, offering customized solutions like process reactors and pilot systems used in Pharma, API and specialty chemicals. We are committed to make more investments in this venture to enhance the product portfolio and geographic reach. For food, beverage, dairy, and agriculture, we provide optimized units which deliver maximum and precise outputs with minimum effort. Our advanced manufacturing facilities, combined with cutting-edge technology and partnerships with global leaders, allow us to deliver customized solutions that meet the highest standards of quality, precision, and reliability. Our integrated CRM software facilitates seamless communication across various functional teams, ensuring that customer needs are addressed in real-time.

To summarize, we are ready to seize new opportunities and look forward to the upcoming strategic developments that pave the way for Borosil Scientific Limited.

We would like to thank each one of you for your support so far and look forward to continued collaboration and mutual growth.

Together, we are now poised

Please contact CT Enterprises for quotation.

Email: sales@ctenterprises.in | Phone: +91 8977721310

Borosil Scientific Expands with Acquisition of Goel Scientific Glassworks Ltd



A BOROSIL Scientific Company



Borosil Scientific successfully acquired Goel Scientific Glass Works Limited (GSGWL) in April 2023, marking a significant milestone in our journey.

GSGWL specializes in manufacturing glass industrial process systems, catering to the pharmaceutical, chemical and defense industries. Renowned as a global leader in crafting intricate and large glass articles with volumes of up to 500 Liters, GSGWL is at the forefront of innovation in these dynamic sectors.

The pharmaceutical, chemical, and defense industries are currently witnessing substantial growth in their research and development endeavors, with process systems playing a pivotal role. By incorporating GSGWL's expertise and products into our portfolio, BSL is well-positioned to meet the evolving needs of our customers with top-notch solutions. This strategic move also aligns with our commitment towards import substitution in this crucial area.

This acquisition not only expands our product offerings but also reflects our dedication to provide world-class products that cater to the diverse requirements of our customers.



WHY BOROSIL

1 Laboratory glassware

- Three out of four glassware articles used in laboratories across India are Borosil branded
- Over 6 decades of trust

Certifications

- Certified for ISO 9001:2015 quality management system for Scientific Laboratory Glassware & Laboratory Equipment / Instrument
- NABL ISO/IEC :17025, 2017 accredited laboratory
- Represents India on ISO/TC 48 – Technical committee for laboratory glassware and apparatus

Quality and Compliance

- Advanced computer controlled machines for calibration
- Laser sensing of meniscus and real-time image of meniscus provided on calibration certificate
- Compliance to international standards ISO/DIN/ASTM for dimensions and tolerances

Infrastructure

- State-of-the-art blowing facility having 700+ skilled blowers
- Equipped with automated blank manufacturing machines
- Annealing process by unique Lehr technology
- Advanced laser machines for laser marking of LIMS compatible QR code and UID code

Unmatched Service Levels

- Network of 150 Channel Partners PAN India
- 4 warehouses across the country
- 96% of the time same day delivery
- Team of 80+ sales ambassadors PAN India
- Customer-centric approach

Please contact CT Enterprises for quotation.

Email: sales@ctenterprises.in | Phone: +91 8977721310

Certifications

Certified for ISO 9001: 2015 Quality Management System, DIN EN ISO 14001: 2015 Environmental Management System, DIN ISO 45001: 2018 Occupational Health & Safety Management System and ISO 50001:2018 Energy Management System for Scientific Laboratory Glassware & Laboratory Equipment



ISO/TC 48



We take the pride to mention that **BOROSIL** represents India on **ISO/TC 48 - Technical Committee for Laboratory equipment and apparatus.**

Please contact CT Enterprises for quotation.

Email: sales@ctenterprises.in | Phone: +91 8977721310

NABL Accredited Testing Laboratory

Operated by trained and certified lab technicians



BOROSIL offers a range of glassware certified as per NABL norms

Volumetric Flasks

Measuring Cylinders

Burettes

Volumetric & Graduated Pipettes

NABL Accreditation Certificate



NABL Product Certificate



Product details

Calibration details

Calibration Equipment traceability

Statement for recalibration

NEW VERSION IS LIVE

Update the BOROSIL app now!

TWO EASY OPTIONS

TO DOWNLOAD THE CERTIFICATE

SCAN QR CODE



ENTER UID CODE

Individual calibration certificate



Please contact CT Enterprises for quotation.

Email: sales@ctenterprises.in | Phone: +91 8977721310

can also be accessed .com

Factory and Production

Automatic Blank Manufacturing Facility



State-of-art auto blowing facility used to produce blanks with uniform wall thickness and ensure exact shape and dimension according to the standards.

All the blanks are manufactured from 3.3 Low Expansion Borosilicate Glass with controlled Internal Diameter tubing.

Unique Annealing Facility



All **Borosil** glassware products pass through annealing Lehr chamber where the stresses are eliminated under controlled heating and cooling process

This annealing process ensures the long lasting printing quality. In order to get the highest level of precision, carefully controlled gradual heating and cooling procedures are essential

Petri Dish Manufacturing Facility



Please contact CT Enterprises for quotation.

Email: sales@ctenterprises.in | Phone: +91 8977721310

Advanced Printing Technology



High definition printing for accurate and easy reading

Wall Thickness Measure



Microscope Slide & Cover Glass Production Line



State-of-the-art facility set up for manufacturing microscope slides at Bharuch factory. The slides are made using best quality raw material and comply with ISO 8037 Standard.

Automated Vial Forming Machine



We are pleased to announce the opening of our new warehouse in Bharuch which was inaugurated by our esteemed Chairman Mr. Pradeep Kheruka, MD Mr. Shreevar Kheruka and COO Mr. Vinayak Patankar on 8th September 2022.

The event marked a new chapter in scaling up our operations with a thought provoking address by AVP - Operations Mr. Jeevan Dogra.

With a new, advanced and bigger facility, this new warehouse is equipped with state of the art safety features. Equipped with the latest facilities, this expanding global

Please contact CT Enterprises for quotation.

Email: sales@ctenterprises.in | Phone: +91 8977721310

Calibration Process



BOROSIL Scientific

is India's single largest manufacturer of a complete range of Volumetric Glassware. Borosil's Volumetric products are used in all laboratories from high-end pharmaceutical production companies to high schools and colleges.



ACCURACY

- Computer Controlled Calibration
- Reliability in experiments through individually certified volumetric glassware
- Facilitates audit procedures in the laboratory
- Enhanced production from new facility

BOROSIL Scientific

adheres to the highest quality standards, right from the raw material used to the measurement and calibration of the finished product. Visual and physical quality checks are undertaken at each stage of production, in order to ensure the highest quality product for customers.



MECHANICAL STRENGTH

- Optimum wall thickness
- Annealed glassware imparts better mechanical strength
- Ideal for vacuum application, wet and dry sterilization
- Harder, hence lasts longer

BOROSIL Scientific

ensures that every Volumetric Glassware product is of the highest quality in the following parameters:



THERMAL SHOCK RESISTANCE

- Safely withstands thermal shock
- Annealed to remove residual thermal Stress
- Thinner, uniform wall, hence lasts longer



CHEMICAL DURABILITY

- High resistance to attack from acids, salt solutions and organic solvents
- Low alkalinity, hence less leaching
- Low alkalinity makes glass harder, hence the glass lasts longer



ISO/IEC 17025:2005 Accredited. Calibration Laboratory
 Computer controlled automatic calibration machine with optical laser beams to prevent human error and ensure highest level of accuracy and precision

BOROSIL Scientific performs the calibration process with fully automatic state-of-the-art calibration machines that eliminate any possibility of human error. This also ensures a high degree of repeatable measurements for all Borosil Volumetric products.

BOROSIL Scientific has an in-house set-up of a well-equipped temperature-controlled calibration laboratory with precision electronic balances, thermometers and stopwatches that are traceable to national standards. Calibration of Volumetric Glassware is entrusted to only trained and experienced technicians.

The following steps are carried out by highly precise, fully automated computer-controlled machines:

1. Filling the Volumetric blanks with a precisely-defined amount of de-mineralized water under controlled temperature.
2. The meniscus is determined with a laser-controlled camera at the exact lowest point of the water level, and the calibration mark is made with a fine diamond wheel. This gives accuracies that cannot be achieved by manual calibration
3. Cylinders, Burettes and Pipettes are marked at a minimum of two calibration points.
4. The wet surface area factor is always taken into account, throughout the process.
5. The calibration laboratory is temperature, light controlled and temperature is maintained at 23°C ± 2°C.

All Volumetric Glassware is calibrated either as

To contain TC / In

The contained quantity of liquid corresponds exactly to the capacity indicated on the article (e.g. graduated cylinders and volumetric flasks).

To deliver TD / Ex

The delivered quantity of liquid corresponds exactly to the capacity indicated on the article. (e.g. pipette and burettes).

These steps ensure that each and every Volumetric product leaving the **BOROSIL Scientific** facility meets the highest international standards and can be used for various purposes with the highest degree of repeatability and accuracy.





Our LabQuest Bottle Top Dispenser officially got **PATENTED** in 2024!

Our innovative dispenser is precisely designed for effortless dismantling for thorough cleaning and autoclaving. Once reassembled, the product can be quickly and accurately returned to its factory-calibrated settings using the calibration markers specified on the included calibration certificate. This ensures precision and reliability with every use. Our patented bottle-top dispensers add value to your laboratories through:

- **Reduced Downtime:** With the ability to perform calibration in-house, users can minimize the time their bottle top dispenser is out of service. This means they can continue using the product without interruption, ensuring seamless workflow and productivity.
- **Cost Effective:** it eliminates the need for costly third-party calibration services, offering a more economical solution for laboratories and research facilities.



Our GMC Heating Mantles got **CE Certified!**

Temperature Controlled Heating Mantles offer consistent, controllable heating with safety cut-off and it is now CE certified to enhance and ensure proven quality, safety, and precision.

What is CE Certification?

Achieving the CE certification is a testament to our commitment to providing superior products that meet the highest standards of quality, safety, and compliance. This prestigious certification signifies that our products meet the essential requirements of the relevant European health, safety, and environmental protection legislation.

What does CE Certification Mean for you?

- **Enhanced Safety:** Our customers can be assured that GMC adheres to the highest safety standards
- **Proven Reliability:** With the addition of CE certification, our customers can trust that GMC is built to last, offering consistent performance and reliability in every use.
- **Quality Redefined:** Built with the best quality material, and now CE certified, GMC aligns with the stringent European standards
- **Market Access:** This certification allows GMC to be marketed across the European Economic Area, making it accessible to a wider audience and ensuring standards of excellence.

OurApp

Enhancing Customer Experience



We launched the Borosil Scientific App, offering users convenient access to detailed product information, resources, and knowledge materials. The app's systematic design ensures a smooth and easy navigation experience. It enhances efficiency and promotes better communication, supporting our branding efforts, all while strengthening our customer relationships.



We are listed on GeM.
Buy our products of your choice at the right price, everytime!

Let us make **Atmanirbhar Bharat**

Please contact CT Enterprises for quotation.

Email: sales@ctenterprises.in | Phone: +91 8977721310

BOROSIL[®] Scientific

INTRODUCING



CERTIFIED

Laboratory Glassware!

We are thrilled to announce a significant update to our laboratory glassware products!

In compliance with the **recent Quality Control Order** issued by the **Central Government**

and in consultation with the Bureau of Indian **Standards (BIS)** dated

1st January 2024,

we have commenced manufacturing select laboratory glassware products with the prestigious

ISI MARK.



What is the ISI Mark?

The **ISI mark** is a certification mark issued by the **Bureau of Indian Standards (BIS)**, the national standards body of India. It signifies that a product conforms to the specifications and quality standards set by BIS. The ISI mark ensures that the product is safe, reliable, and of good quality for consumers.

Benefits of the ISI Mark for Manufacturers

The **ISI mark** helps manufacturers ensure product quality, comply with regulations, and build consumer trust. It enhances market access, brand reputation, and competitiveness while promoting consistent quality and reducing liabilities. Overall, it supports business growth and symbolizes reliability.

Please contact CT Enterprises for quotation.

Email: sales@ctenterprises.in | Phone: +91 8977721310

"A local Global" with exports to 90+ Countries

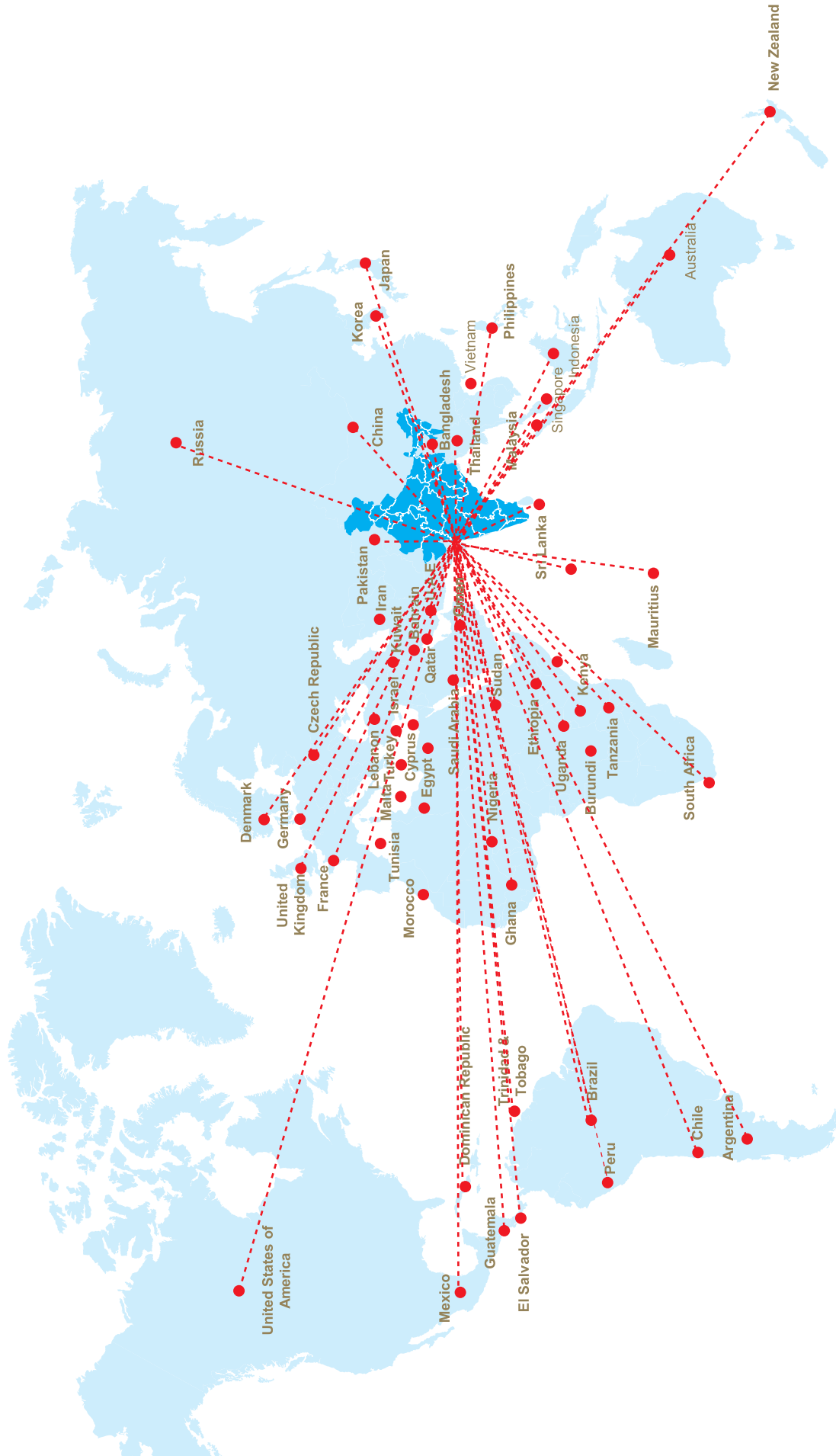

Please contact CT Enterprises for quotation.
Email: sales@ctenterprises.in | Phone: +91 8977721310

"Industry leading distribution network"

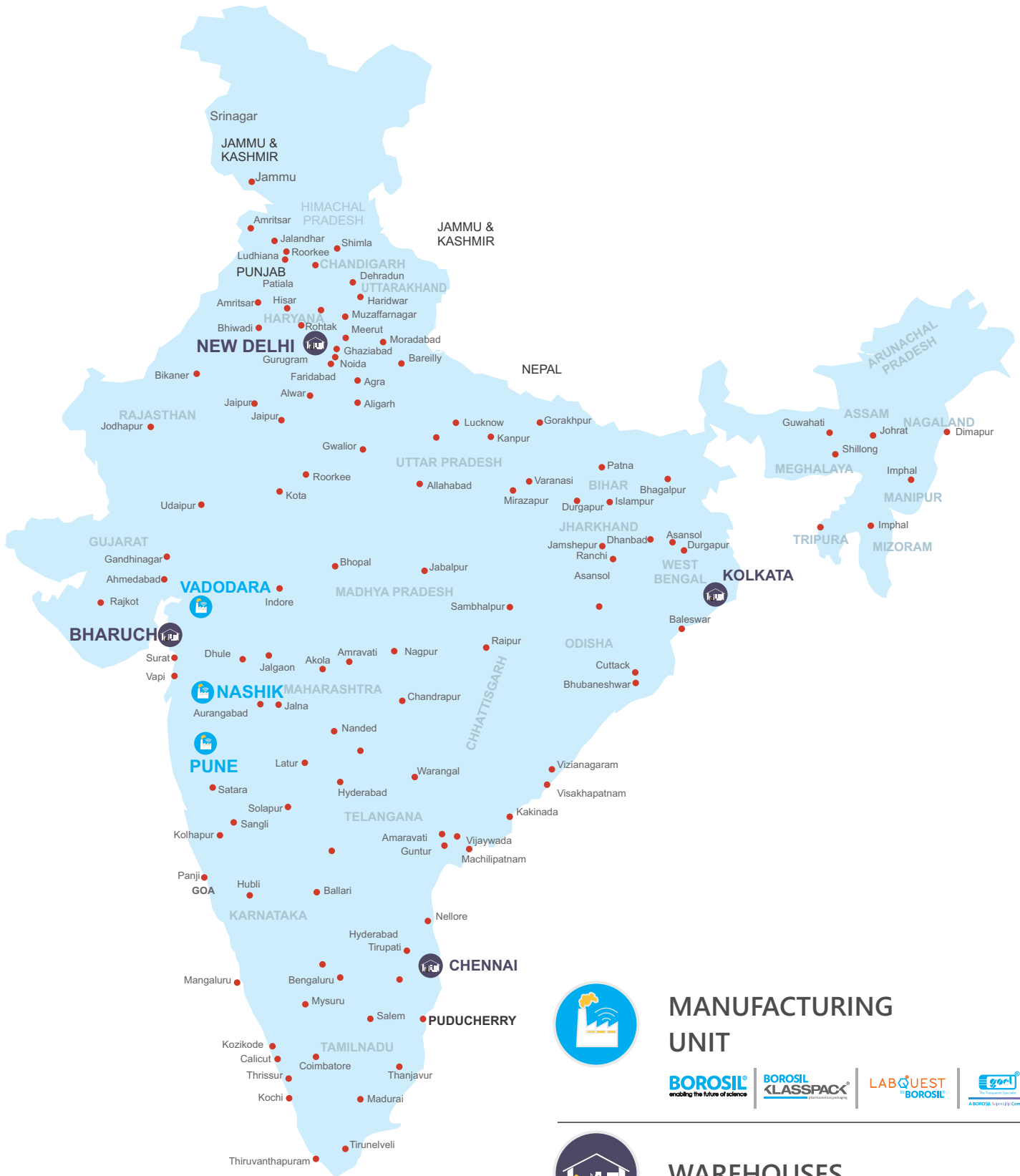

MANUFACTURING UNIT



WAREHOUSES

- BHARUCH
- DELHI
- CHENNAI
- KOLKATA



PAN INDIA NETWORK OF 150 CHANNEL PARTNERS

Please contact CT Enterprises for quotation.
 Email: sales@ctenterprises.in | Phone: +91 8977721310



Ecologically Responsible

Rain water harvesting has been deployed in our 110 acre facility in Gujarat, since 2003.

Wind energy is the source of 48% of all the electricity that we consume.

Our Borosolar water heating systems are used to heat the water supplied in all Borosil Guesthouses and Colonies..

Our other energy efficient measures include advanced waste heat recovery systems and solar lighting.

Our in-house 9 hole par 36 Golf Course is maintained by using the water from our rain water harvesting initiative.

WE nurture

Borosil supports and runs a school, for children from neighbouring villages and employees' children.

Borosil proposes to open a hospital in the near future.



WE care

Borosil supports GLOBAL PARLI - A Mission to Transform India Through Rural Economic Transformation



4.1 Mn+
Fruit Trees Planted Till February 2021



New Beginnings

BSL Listing on BSE and NSE on 7 June, 2024



Borosil Scientific has officially been listed on the **Bombay Stock Exchange Limited (BSE)** and the **National Stock Exchange of India Limited (NSE India)**! Held on June 7th, 2024, at the Bombay Stock Exchange Limited (BSE), the bell-ringing ceremony was made possible by the steadfast support of their team.

From our beginnings to this momentous occasion, our journey has been fueled by dedication, innovation, and the unwavering support of our stakeholders.

Special thanks to Mr. Pradeep Kheruka, Promoter of Borosil Group, **Mr. Shreevar Kheruka**, Managing Director, Borosil Ltd. and **Mr. Vinayak Patankar**, Whole-time Director & CEO of Borosil Scientific Ltd.

Their leadership and guidance have been invaluable to our journey.



Please contact CT Enterprises for quotation.

Email: sales@ctenterprises.in | Phone: +91 8977721310

Foreword

Borosil Scientific Limited presents to you, this Scientific and Laboratory Glassware Pricelist. Unless, specific arrangements have been made to the contrary, the prices contained in this Pricelist are applicable to all goods despatched on or after **April 01, 2025**.

This Pricelist supersedes all previous prices. All prices stated herein are the recommended maximum price per piece in INR, and are exclusive of All Taxes, Goods and Services Tax (GST), any delivery charges, other statutory and non statutory levies The dealers are at liberty to charge prices lower than those stipulated them

Customised Glassware

We undertake the manufacture of special glassware to agreed specifications. Please send us your queries at the address below, including complete details of specifications, and drawings wherever possible. We would be pleased to assist you in formulating specifications within normal working tolerances. Usually, we only accept orders with a minimum ex-works value of INR 10,000/-

Corporate Office :

Borosil Scientific Limited

Crescenzo, G-Block, Opp. MCA Club,

Bandra Kurla Complex,

Bandra (E), Mumbai - 400 051, India

Tel : 022 - 6740 6300

Fax : 022 - 6740 6514

Email : lab.customercare@borosil.com / bsl@borosil.com

Conditions of Sale

At Borosil Scientific, it is our policy to market our laboratory glassware through our wide network of Authorised Dealers. Strategically located all over India, they are best equipped to satisfy the Individual requirements of users across the nation. The products supplied will usually be in accordance with illustration and description however, **Borosil Scientific reserves the right to make alterations and modifications depending upon circumstances and /or changes in official specifications, or as a result of design improvements.**

Although the products are guaranteed for glass quality and workmanship. Borosil shall not be liable for any loss or damage or injury, arising directly or indirectly from the use of these products.

The images given in the Pricelist are for reference purpose only.
Actual products may differ from the images.

Beaker
26 - 28

Bottles
30 - 45

Burettes
46 - 58

Cones
60 - 61

- Beakers
- Bottles
- Burettes
- Cones

Condensers
62 - 64

Cylinders
66 - 73

Hydrometers **NEW**
74 - 77

Desiccators
78 - 79

- Condensers
- Cylinders
- Hydrometers
- Desiccators

Dishes
80 - 82

Distilling Apparatus
84 - 88

Water Distillation Unit
90 - 95

Survimeter & Viscometer
96 - 97

- Dishes
- Distilling Apparatus
- Water Distilling Unit
- Survimeter & Viscometer

Extractors
98 - 101

Flasks
102 - 125

Filtration Products
126 - 139

- Extraction Apparatus
- Flasks
- Filtration Products

Volumetric Flask & Columns
140 - 155

Funnels
156 - 159

Cones
160 - 161

Gas Generator
161

Jars & Kettles
162 - 163

- Volumetric Flasks & Columns
- Funnels
- Cones
- Gas Generator
- Jars & Kettles

Pipettes
164 - 174

Weighing Scoop
176

Mortar and Pestle
176

Tubes
177 - 180

- Pipettes
- Weighing Scoop
- Mortar and Pestle
- Tubes

Adapters
181 - 190

Test Tubes, Stirrer Rod Culture Tubes
192 - 198

Watch Glasses
199

Sintered Ware
200 - 203

Quartz Ware & Silica Ware
204 - 210

- Adapters
- Test Tubes, Stirrers Rod Culture Tubes
- Watch Glass
- Sintered Ware
- Quartz Ware

Slides & Cover Glasses
212 - 213

Lab Accessories & Silicone **NEW**
214 - 223

Vials
224 - 233

Laboratory Filter Media
234 - 251

Syringe Filters **NEW**
252 - 255

- Slides & Cover Glasses
- Lab Accessories & Silicone
- Vials
- Laboratory Filter Media
- Syringe Filters

Proximate Analysis
258 - 273

Environment
274 - 283

Lab Essentials
284 - 293

Liquid Handling
294 - 303

Process
304 - 407

- Proximate Analysis
- Environment Analysis
- Lab Synthesis
- Liquid Handling & Life Science
- Process Science

Please contact CT Enterprises for quotation.
Email: sales@ctenterprises.in | Phone: +91 8977721310

Beakers

Whether it is research, industry or education, the Beaker has a wide range of applications. This simple container, used for stirring and mixing liquids, is also ideal for heating them. Controlled wall thickness at the sides, radius and the base, ensures a fine balance between the thermal resistance and mechanism strength, to enable effective heating. Many Beakers also have a spout that makes pouring easier and more precise.

BOROSIL Scientific Glassware are best-in-class products with several advantages. They have a high level of thermal shock resistance and a high operating temperature. Besides using USP type I borosilicate glass constant quality control checks are conducted throughout the production process to ensure uniformity of the wall thickness. Such uniform wall thickness distribution prevents uneven expansion and stressing of the glass that often results in a failure.

Beakers are mainly used as heating vessels. The tall-shape design of the Beaker is ideal for heating in a liquid bath, especially when the contents need to be kept distinctly apart from the surrounding medium or materials,

BOROSIL Scientific brand Low Form Beaker (Cat. No. 1000) and **BOROSIL Scientific** brand Tall Form Beaker (Cat. No. 1060) are two popular styles used for storage and mixing.

BOROSIL Scientific offers full range of beakers to suit every applications.



Made from 3.3 Low Expansion Borosilicate Glass

USP
TYPE I

TYPE I
ASTM
E438

ISO
3585

Please contact CT Enterprises for quotation.

Email: sales@ctenterprises.in | Phone: +91 8977721310

1000 - LOW FORM BEAKER

With Spout

- Complies with IS 2619 /ISO 3819 and DIN 12331 **with ISI Mark**
- The spout design enables clean and precise pouring
- Graduated to indicate the approximate content
- Uniform wall thickness distribution improves mechanical & thermal properties & makes it ideal for heating liquids
- The easy-to-read scale and large labelling field makes marking easier
- High resistance to chemical attack

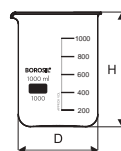

- Beakers
- Bottles
- Burettes
- Cones

Product Code	Capacity ml	Approx O.D. x Height mm	Quantity Per Case	Price / Piece ₹
1000005	5*	22 x 30	20	155.00
1000006	10*	26 x 35	20	155.00
1000009	25	34 x 50	60	155.00
1000D12	50	42 x 60	60	110.00
1000D16	100	50 x 70	40	110.00
1000D18	150	60 x 80	40	110.00
1000D21	250	70 x 95	40	120.00
1000D23	400	80 x 110	40	190.00
1000D24	500	83 x 115	40	185.00
1000D25	600	90 x 125	40	260.00
1000D28	800	100 x 135	20	375.00
1000D29	1000	105 x 145	20	375.00
1000D30	2000	130 x 185	6	765.00
1000D31	3000	150 x 210	4	2065.00
1000D33	5000	170 x 270	4	3030.00
1000D38	10000	220 x 350	1	9730.00

* 5 ml and 10 ml Beakers are not graduated.

1040 - TALL FORM BEAKER

Without Spout

- Complies with IS 2619 / ISO 3819 and DIN 12331
- Graduated to indicate the approximate content
- Uniform wall thickness distribution improves mechanical & thermal properties & makes it ideal for heating liquids
- The easy-to-read scale and large labelling field makes marking easier
- High resistance to chemical attack
- Ideal for titrations

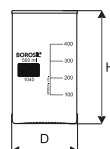

Product Code	Capacity ml	Approx O.D. x Height mm	Quantity Per Case	Price / Piece ₹
1040012	50	38 x 70	40	160.00
1040016	100	50 x 80	40	165.00
1040018	150	54 x 95	40	170.00
1040021	250	60 x 120	40	180.00
1040024	500	80 x 140	20	260.00
1040025	600	80 x 150	20	335.00
1040028	800	90 x 175	20	410.00
1040029	1000	95 x 180	20	500.00

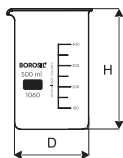

1060 - TALL FORM BEAKER With Spout

- Complies with IS 2619 / EN ISO 3819 and DIN 12331 **with ISI Mark**
- Graduated to indicate the approximate content
- The spout design enables clean and precise pouring
- Uniform wall thickness distribution improves mechanical & thermal properties & makes it ideal for heating liquids
- The easy-to-read scale and large labelling field makes marking easier
- High resistance to chemical attack
- Ideal for titrations

Product Code	Capacity ml	Approx O.D. x Height mm	Quantity Per Case	Price / Piece ₹
1060012	50	38 x 70	40	190.00
1060D16	100	50 x 80	40	195.00
1060018	150	54 x 95	40	200.00
1060D21	250	60 x 120	40	195.00
1060D24	500	80 x 140	20	270.00
1060025	600	80 x 150	20	420.00
1060028	800	90 x 175	20	495.00
1060D29	1000	95 x 180	20	535.00

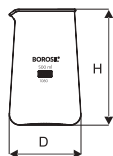

1080 - PHILLIP (CONICAL) BEAKER With Spout

- Conical shape (Phillips pattern) with spout
- Its mouth is smaller in diameter than its base
- The Phillips Beaker is ideal for measuring, containment, mixing and decanting

Product Code	Capacity ml	Approx O.D. x Height mm	Quantity Per Case	Price / Piece ₹
1080021	250	68 x 110	40	865.00
1080024	500	88 x 145	40	1080.00

BOROSIL®
Scientific

Tongs For Beakers & Flasks

- Made of stainless steel
- Used to handle hot beakers
- Provided with silicon sleeves or in fibre glass yarn to resist direct flame



For more details please refer page no. 215

SQUARE BOTTLES

*A smart solution for
all your storage needs...*

e

Filling

a

Pouring

s

Handling

y

Cleaning

Ideal for storage and transfer of

- APIs and excipients
- Bulk drug intermediates and intermediate products in biopharma manufacturing
- Laboratory chemicals and solvents



Square shape enables stacking of bottles during usage, storage and transport

Extra wide **GL 80 neck** gives ease of pouring & filling of liquids as well as powders

Wide neck makes cleaning easy

Large stable base helps prevent tumbling of the bottle

Flat sides of the bottle act as a baffle and helps in effective mixing

Please contact CT Enterprises for quotation.

Email: sales@ctenterprises.in | Phone: +91 8977721310

Reagent Bottles



BOROSIL Scientific Laboratory bottles are chemically resistant and stable. When fitted with pouring ring, dripping can be totally eliminated. As there is only one size of screw thread for all bottles from 100 ml onwards, the screw caps and pouring rings are fully interchangeable. The bottles, pouring rings and caps are autoclavable and sterilizable.

For AMBER Bottles, ambering is done on the external surface only, hence properties within the bottle remain unchanged. It protects the media from light radiations of wavelengths between 300nm and 500 nm.

Made from 3.3 Low Expansion Borosilicate Glass



Please contact CT Enterprises for quotation.

Email: sales@ctenterprises.in | Phone: +91 8977721310

1220 - ASPIRATOR BOTTLES

With Tubulation and PP Cap

- Complies with IS 1388 (Part III), ISO 4796-3
- Supplied with GL45 screw caps and pouring ring made of polypropylene, autoclavable at 121°C
- All sizes have a durable matt-finished enamelled area for marking
- Suitable for storage of aggressive media



Product Code	Capacity ml	Approx O.D. x Height* mm	Thread Specification	Quantity Per Case	Price / Piece ₹
1220021	250**	70 x 140	GL 45	10	540.00
1220024	500**	86 x 176	GL 45	10	625.00
1220029	1000	101 x 225	GL 45	10	1095.00
1220030	2000	136 x 260	GL 45	5	1745.00
1220033	5000	181 x 316	GL 45	1	10010.00
1220038	10000***	235 x 410	GL 45	1	16945.00
1220040	20000***	296 x 505	GL 45	1	30800.00

**Not covered in ISO / DIN standards.

*Height indicated is of Bottle only

***As per Borosil Scientific dimension

1240 - ASPIRATOR BOTTLES

With Socket Outlet For Stopcock and PP Cap

- Complies with IS 1388 (Part III), ISO 4796-3
- Supplied with GL45 screw caps and pouring ring made of polypropylene, autoclavable at 121°C
- All sizes have a durable matt-finished enamelled area for marking
- Suitable for storage of aggressive media



Product Code	Capacity ml	Approx O.D. x Height* mm	Thread Specification	Outlet Ground Joint Size	Quantity Per Case	Price / Piece ₹
1240029	1000	101 x 225	GL 45	19 / 26	10	1360.00
1240030	2000	136 x 260	GL 45	19 / 26	5	1950.00
1240033	5000	181 x 316	GL 45	29 / 32	1	11270.00
1240038	10000***	235 x 410	GL 45	29 / 32	1	15970.00
1240040	20000***	296 x 505	GL 45	29 / 32	1	27450.00

*Height indicated is of Bottle only

***As per Borosil Scientific dimension

Glass stopcock available on request

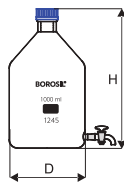

1245 - ASPIRATOR BOTTLES With I/C Glass Stopcock and PP Cap

- Complies with IS 1388 (Part III), ISO 4796-3
- Supplied with GL45 screw caps and pouring ring made of polypropylene, autoclavable at 121°C
- All sizes have a durable matt-finished enamelled area for marking
- Suitable for storage of aggressive media

Product Code	Capacity ml	Approx O.D. x Height* mm	Thread Specification	Outlet Ground Joint Size	Quantity Per Case	Price / Piece ₹
1245029	1000	101 x 225	GL 45	19 / 26	10	3780.00
1245030	2000	136 x 260	GL 45	19 / 26	4	4465.00
1245033	5000	181 x 316	GL 45	29 / 32	1	14790.00
1245038	10000***	235 x 410	GL 45	29 / 32	1	20850.00
1245040	20000***	296 x 505	GL 45	29 / 32	1	30970.00

*Height indicated is of Bottle only
 ***As per Borosil Scientific dimension

Spare glass stopcock available on request

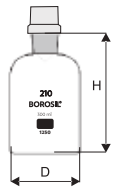

1250 - B.O.D. BOTTLES

- Complies with IS 9213
- Supplied with Interchangeable glass stopper and plastic cap
- Individual number printed on the bottle
- Used for determination of Biological Oxygen Demand in industrial effluents, waste and water

Product Code	Capacity ml	Approx O. D. x Height* mm	Quantity Per Case	Price / Piece ₹
1250013	60**	42 x 100	10	595.00
1250017	125**	55 x 120	10	735.00
1250022	300	70 x 143	30	855.00

*Height indicated is of Bottle only
 **60 & 125 ml are not covered in standards
 300 ml is for determination of B.O.D. in Industrial effluents, wastes and water as per method specified by the American Public Health Association

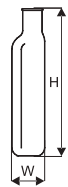

1290 - ROUX BOTTLES WITH OFF SET NECK

- Complies with IS 6942
- The offset neck is tool-finished for greater strength and uniform stopper fit
- Withstands repeated sterilisation cycles (wet or dry)
- These bottles facilitate the growing of mass cultures and monolayer cultures

Product Code	Capacity ml	Approx B x W x H mm	Approx Neck I. D. mm	Quantity Per Case	Price / Piece ₹
1290029	1000	126 x 56 x 265	25	20	2385.00

1500 - REAGENT BOTTLES

Narrow Mouth With I/C Glass Stopper

- Complies with IS 1388 (Part II), ISO 4796 - 2
- Supplied with solid glass stopper
- Printed with graduations using a durable white enamel
- Bottles are mechanically strong and chemical resistant with a sturdy ground neck

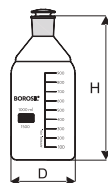

Product Code	Capacity ml	Approx O.D. x Height* mm	Neck Stopper Size	Quantity Per Case	Price / Piece ₹
1500013	60**	45 x 90	14 / 23	20	470.00
1500016	100	56 x 100	19 / 26	10	515.00
1500017	125**	56 x 120	19 / 26	20	465.00
1500021	250	70 x 138	19 / 26	10	510.00
1500024	500	86 x 177	24 / 29	10	515.00
1500029	1000	101 x 225	29 / 32	5	900.00
1500030	2000	136 x 260	34 / 35	5	1520.00

*Height indicated is of Bottle only

**60 & 125 ml is not covered in standards

1501 - REAGENT BOTTLES

Narrow Mouth With Screw Cap

- Complies with IS 1388 (Part I), ISO 4796 - 1
- Supplied with screw caps and pouring ring made of polypropylene, autoclavable at 121°C
- Printed with graduations and retrace code using a durable white enamel
- 100 ml to 20000 ml Bottles have uniform GL 45 thread
- Mechanically strong and chemical resistant
- Ideal for storage of chemicals, reagents, media



Product Code	Capacity ml	Approx O.D. x Height* mm	Thread Specification	Quantity Per Case	Price / Piece ₹
1501006	10**#	36 x 50	GL 25	10	585.00
1501009	25#	36 x 70	GL 25	20	390.00
1501012	50	46 x 87	GL 32	20	480.00
1501016	100	56 x 100	GL 45	10	425.00
1501018	150**	60 x 120	GL 45	10	505.00
1501021	250	70 x 138	GL 45	10	435.00
1501024	500	86 x 177	GL 45	10	480.00
1501029	1000	101 x 225	GL 45	10	735.00
1501030	2000	136 x 260	GL 45	10	1315.00
1501031	3000**	158 x 295	GL 45	2	6800.00
1501033	5000***	181 x 316	GL 45	1	7675.00
1501038	10000***	235 x 410	GL 45	1	12665.00
1501040	20000***	296 x 505	GL 45	1	23680.00

- *Height indicated is of Bottle only

- #Without Pouring Ring

- **Not covered in any standard

- ***As per Borosil Scientific Dimension

BOROSIL[®]
Scientific

Premium Grade Bottles

Made for Pharmaceutical and
Bio Pharmaceuticals applications

*Ideal for storage, transfer and transport of formulations, APIs,
bulk drugs and biopharma products*



High Temperature Resistant Screw Caps

Available for
Extractable
Data

- Manufactured from 3.3 Borosilicate glass complying to USP, ASTM and ISO standards
- Meets the quality requirements of international pharmacopoeias
- Designed to meet the regulatory requirements of storage containers
- A reliable choice of bottle to fulfil the increasingly tighter regulations of pharma and biotech industries

Please contact CT Enterprises for quotation.

Email: sales@ctenterprises.in | Phone: +91 8977721310

Still stuck with
the old method
for transferring HPLC solvents ?



BOROSIL[®]
Scientific
is right here with a solution

PROUDLY MADE IN 
india

Multi-Port HPLC Cap with Anti-twist mechanism

*A smart solution for transfer of
HPLC mobile phase solvents*

Unique air valve cum filter

0.1µm filter prevents contamination of solvents with dust particles and the release of solvent vapours thereby maintaining the solvent concentration

PP fittings for different tubing ODs

Supplied with three connectors – for 3.2 mm and 1.6 mm OD tubing alongwith one end plug

Polypropylene Cap

Suitable for all types of GL 45 bottles and autoclavable at 121°C

Anti-twist mechanism

Freely rotatable PTFE manifold prevents twisting of the tubes while opening and closing the cap



Product Code	No of Ports	Neck	Quantity per Pack
1513C04	4	GL45	4 Nos
1513C02	2	GL45	4 Nos
1513C01	1	GL45	4 Nos

Please contact CT Enterprises for quotation.

Email: sales@ctenterprises.in | Phone: +91 8977721310

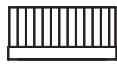

1503 - SCREW CAPS FOR BOTTLES

- Made of polypropylene (PP)
- Supplied with PP pouring rings
- Autoclavable at 121°C
- Available in 5 different colours

Product Code	Colour Description	Thread Specification	Quantity Per Case	Price / Piece ₹
1503C01	Blue	GL 45	10	115.00
1503C02	Orange	GL 45	10	120.00
1503C03	Yellow	GL 45	10	120.00
1503C04	Green	GL 45	10	120.00
1503C05	Grey	GL 45	10	120.00
1503C06	Blue	GL 25*	10	110.00
1503C07	Blue	GL 32*	10	110.00
1503C08	Blue	GL 36*	10	110.00

HSN Code: 39235010

Without pouring ring



1505 - HIGH TEMPERATURE RESISTANT SCREW CAPS

- Made of Polybutylene Terephthalate (PBT)
- Supplied with a silicone/PTFE liner and pouring ring
- Temperature resistance: - 40°C to +180°C
- Withstand sterilization conditions: hot air sterilization in oven upto 180°C and steam sterilization in autoclave at 121°C

Product Code	Colour Specification	Thread Specification	Quantity Per Case	Price / Piece ₹
1505C01	Red	GL - 45	10	875.00

HSN Code: 39235010



1513 - MULTI-PORT HPLC CAP For HPLC Solvent Transfer

- Polypropylene Cap Suitable for all types of GL 45 bottles and
- Autoclavable at 121°C
- PP fittings for different tubing ODs Supplied with three connectors
- Anti-twist mechanism Freely rotatable
- Unique air valve cum filter

Product Code	No of Ports	Neck	Quantity Per Case	Price / Piece ₹
1513C04	4	GL 45	4	3945.00
1513C02	2	GL 45	4	3815.00
1513C01	1	GL 45	4	3640.00

1506 - REAGENT BOTTLES

Wide Mouth With Screw Cap, Square

- Supplied with GL80 screw caps and pouring ring made of polypropylene, autoclavable at 121°C
- Square shape enables stacking of bottles during usage, storage and transport
- Extra wide GL 80 neck gives ease of pouring & filling of liquids as well as powders
- Large stable base helps prevent tumbling of the bottle
- Ideal for storage and transfer of pharma and biopharma products

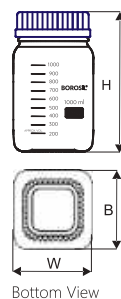

Product Code	Capacity ml	Approx B x W x H mm	Thread Specification Approx O.D. mm	Quantity Per Case	Price / Piece ₹
1506024	500	94 x 94 x 141	GL-80	10	1275.00
1506029	1000	105 x 105 x 187	GL-80	10	1410.00
1506030	2000	115 x 115 x 260	GL-80	10	2220.00
1506033	5000	160 x 160 x 357	GL-80	1	13695.00

*Height indicated is of Bottle only

1507 - REAGENT BOTTLES

Wide Mouth with Screw Cap, Square, Amber

- Supplied with GL80 screw caps and pouring ring made of polypropylene, autoclavable at 121°C
- Square shape enables stacking of bottles during usage, storage and transport
- Extra wide GL 80 neck gives ease of pouring & filling of liquids as well as powders
- Large stable base helps prevent tumbling of the bottle
- Ideal for storage and transfer of pharma and biopharma products
- Uniform amber colour protects media from light radiation with a wave-length between 300 nm and 500 nm
- Ideal for use with light-sensitive media and for the long-term storage of substances

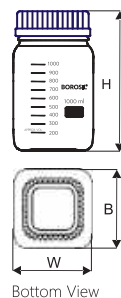

Product Code	Capacity ml	Approx B x W x H mm	Thread Specification Approx O.D. mm	Quantity Per Case	Price / Piece ₹
1507024	500	94 x 94 x 141	GL-80	10	1725.00
1507029	1000	105 x 105 x 187	GL-80	10	1910.00
1507030	2000	115 x 115 x 260	GL-80	10	3005.00
1507033	5000	160 x 160 x 357	GL-80	1	18495.00

*Height indicated is of Bottle only

*Tailor made bottle supply with GL 80 screw thread

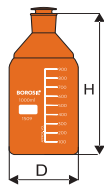

1509 - REAGENT BOTTLES

Narrow Mouth With I/C Glass Stopper, Amber

- Complies with IS 1388 (Part II), ISO 4796 - 2
- Supplied with solid glass stopper
- Printed with graduations using a durable white enamel
- Bottles are mechanically strong and chemical resistant with a sturdy ground neck
- Uniform amber colour protects media from light radiation with a wave-length between 300 nm and 500 nm
- Ideal for use with light-sensitive media and for the long-term storage of substances

Product Code	Capacity ml	Approx O.D. x Height* mm	Neck Stopper Size	Quantity Per Case	Price / Piece ₹
1509013	60**	45 x 100	14 / 23	20	670.00
1509016	100	56 x 100	14 / 23	10	745.00
1509017	125**	56 x 120	19 / 26	20	700.00
1509021	250	70 x 138	19 / 26	10	880.00
1509024	500	86 x 177	24 / 29	10	1025.00
1509029	1000	101 x 225	29 / 32	5	1325.00
1509030	2000	136 x 260	34 / 35	5	2445.00

*Height indicated is of Bottle only

**60 & 125 ml is not covered in standards



1519 - REAGENT BOTTLES

Narrow Mouth With Screw Cap, Amber

- Complies with IS 1388 (Part I), ISO 4796 - 1
- Supplied with screw caps and pouring ring made of polypropylene, autoclavable at 121°C
- Printed with graduations and retrace code using a durable white enamel
- 100 ml to 20000 ml Bottles have uniform GL 45 thread
- Mechanically strong and chemical resistant
- Uniform amber colour protects media from light radiation with a wave-length between 300 nm and 500 nm
- Ideal for use with light-sensitive media and for the long-term storage of substances

Product Code	Capacity ml	Approx O.D. x Height* mm	Thread Specification	Quantity Per Case	Price / Piece ₹
1519006	10**#	36 x 50	GL 25	10	740.00
1519009	25#	36 x 70	GL 25	20	625.00
1519012	50#	46 x 87	GL 32	20	725.00
1519016	100	56 x 100	GL 45	10	750.00
1519021	250	70 x 138	GL 45	10	790.00
1519024	500	86 x 177	GL 45	10	945.00
1519029	1000	101 x 225	GL 45	10	1235.00
1519030	2000	136 x 260	GL 45	10	2315.00
1519031	3000**	158 x 295	GL 45	2	12360.00
1519033	5000***	183 x 316	GL 45	1	12760.00
1519038	10000***	235 x 410	GL 45	1	18570.00
1519040	20000***	296 x 500	GL 45	1	33575.00

- *Height indicated is of Bottle only

#Without Pouring rings

**Not covered in any standard

***As per BOROSIL Scientific dimensions

1585 - SOLUTION BOTTLES

With Tooled Neck

- Complies with IS 1388 (Part II), ISO 4796 - 2
- 10, 20 & 50 litre bottles specially designed for handling and storing culture media
- All sizes have a durable matt-finished enamelled area for marking

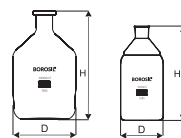

Product Code	Capacity ml	Approx O.D. x Height mm	Approx Neck I. D. mm	Quantity Per Case	Price / Piece ₹
1585021	250	70 x 145	18	20	510.00
1585024	500	86 x 180	23	20	545.00
1585029	1000	101 x 230	28	10	860.00
1585030	2000	136 x 255	33	10	1460.00
1585031	3000	158 x 255	44	4	7255.00
1585033	5000	183 x 320	44	1	8930.00
1585038	10000*	235 x 430	54	1	15265.00
1585040	20000*	296 x 530	54	1	25340.00
1585046	50000*	417 x 665	89	1	120495.00

*As per Borosil Scientific dimensions

1589 - SOLUTION BOTTLES

With Tooled Neck, Amber

- Complies with IS 1388 (Part II), ISO 4796 - 2
- 10, 20 & 50 litre bottles specially designed for handling and storing culture media
- All sizes have a durable matt-finished enamelled area for marking
- Uniform amber colour protects media from light radiation with a wave-length between 300 nm and 500 nm
- Ideal for use with light-sensitive media and for the long-term storage of substances



Product Code	Capacity ml	Approx O.D. x Height mm	Approx Neck I. D. mm	Quantity Per Case	Price / Piece ₹
1589021	250	70 x 145	18	10	930.00
1589024	500	86 x 180	23	20	965.00
1589029	1000	101 x 230	28	5	1410.00
1589030	2000	136 x 255	33	5	2435.00
1589031	3000	158 x 255	44	4	10425.00
1589033	5000	183 x 320	44	1	11665.00
1589038	10000*	235 x 430	54	1	20610.00
1589040	20000*	296 x 530	54	1	33110.00

*As per Borosil Scientific dimensions

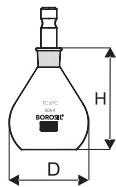

1624 - RELATIVE DENSITY BOTTLES (Pyknometer) With I/C PTFE Stopper With Class A Certificate

- Supplied with I/C PTFE (Teflon) stopper
- These bottles are mechanically strong and chemical resistant
- All sizes have a durable matt-finished enamelled area for marking
- Provided with certificate

Product Code	Capacity ml	Capacity Tolerance \pm ml	Max. Body Dia x Height mm	Size of Inter-Changeable Stopper	Quantity Per Case	Price / Piece ₹
1624006	10	0.3	29 x 48	10 / 15	5	1380.00
1624009	25	0.8	40 x 55	10 / 15	5	1630.00
1624012	50	1	50 x 65	10 / 15	5	1715.00

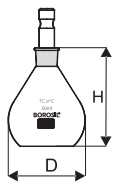

1625 - RELATIVE DENSITY BOTTLES (Pyknometer) With I/C PTFE Stopper

- Supplied with I/C PTFE (Teflon) stopper
- Complies with IS 5717, DIN / ISO 3507
- These bottles are mechanically strong and chemical resistant
- All sizes have a durable matt-finished enamelled area for marking

Product Code	Capacity ml	Capacity Tolerance \pm ml	Max. Body Dia x Height mm	Size of Inter-Changeable Stopper	Quantity Per Case	Price / Piece ₹
1625006	10	1	29 x 48	10 / 15	10	655.00
1625009	25	2	40 x 55	10 / 15	10	725.00
1625012	50	3	50 x 65	10 / 15	5	775.00



1627 - SPECIFIC GRAVITY BOTTLES (PYKNOMETER) With Thermometer And Capillary Side Tube

- Complies with IS 5717, DIN / ISO 3507
- These bottles are mechanically strong and chemical resistant
- All sizes have a durable matt-finished enamelled area for marking
- Supplied with thermometer alongwith certificate for thermometer

Product Code	Capacity ml	Tolerance \pm ml	Max. Body Dia x Height mm	Size of I/C Stopper	Quantity Per Case	Price / Piece ₹
1627006	10	1	29 x 48	10 / 19	5	1865.00
1627009	25	2	40 x 55	10 / 19	5	2185.00
1627012	50	3	50 x 65	10 / 19	5	2370.00

1630 - WEIGHING BOTTLES

With I/C Glass Lid

- Complies with IS 1574
- These bottles are mechanically strong and chemical resistant

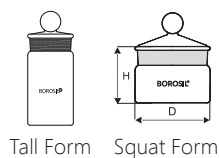

Tall Form Squat Form



Product Code	Capacity ml	Approx O.D. x Height* mm	Quantity Per Case	Price / Piece ₹
1630005	5	20 x 45	30	345.00
1630007	15	26 x 65	10	370.00
1630008	20**	50 x 35	10	635.00
1630009	25	30 x 65	10	430.00
1630011	40**	60 x 40	10	860.00
1630013	60	40 x 90	5	625.00

*Height indicated is of Bottle only

**Squat Form

1631 - WEIGHING BOTTLES

With I/C Glass Lid, Amber

- Complies with IS 1574
- These bottles are mechanically strong and chemical resistant
- Suitable for light sensitive substance.

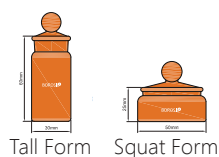

Tall Form Squat Form



Product Code	Capacity ml	Approx O.D. x Height* mm	Quantity Per Case	Price / Piece ₹
1631005	5	20 x 45	30	445.00
1631007	15	26 x 65	10	465.00
1631008	20**	50 x 35	10	830.00
1631009	25	30 x 65	10	540.00
1631011	40**	60 x 40	10	1075.00
1631013	60	40 x 90	5	815.00

*Height indicated is of Bottle only

**Squat Form

1640 - DROPPING BOTTLES

With Glass Dropper & Silicone Teat

- Supplied with interchangeable ground joint glass dropper and rubber teat
- Highly chemical resistance

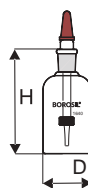

Product Code	Capacity ml	Approx O.D. x Height mm	Socket Size	Quantity Per Case	Price / Piece ₹
1640010	30	34 x 86	14 / 23	10	410.00
1640013	60	42 x 100	14 / 23	10	555.00
1640017	125	55 x 120	19 / 26	10	585.00
1640021	250	65 x 147	19 / 26	10	775.00





1650 - DROPPING BOTTLES

With Glass Dropper & Silicone Teat, Amber

- Supplied with interchangeable ground joint glass dropper and rubber teat
- Highly chemical resistance
- Suitable for light sensitive substance.

Product Code	Capacity ml	Approx O.D. x Height mm	Socket Size	Quantity Per Case	Price / Piece ₹
1650010	30	35 x 84	14 / 23	10	670.00
1650013	60	42 x 100	14 / 23	10	935.00
1650017	125	55 x 120	19 / 26	10	965.00
1650021	250	65 x 147	19 / 26	10	1265.00

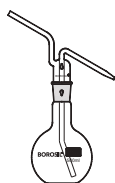

1660 - GLASS WASH BOTTLE

Set With I/C Stopper

- These bottles are mechanically strong and chemical resistant
- All sizes have a durable matt-finished enamelled area for marking

Product Code	Capacity ml	Approx OD mm	Approx Height mm	Size of Inter-changeable Stopper	Quantity Per Case Set	Price / Piece ₹
1660021	250	85	130	24 / 29	5	1015.00
1660024	500	105	160	24 / 29	5	1270.00
1660029	1000	131	195	29 / 32	5	1565.00

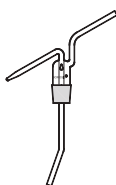

1661 - STOPPER FOR GLASS WASH BOTTLE

Product Code	Capacity ml	Size of Inter-changeable Stopper	Quantity Per Case	Price / Piece ₹
1661021	250	24 / 29	5	665.00
1661024	500	24 / 29	5	715.00
1661029	1000	29 / 32	5	745.00

1662 - FLASK FOR GLASS WASH BOTTLE

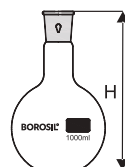

Product Code	Capacity ml	Approx OD mm	Approx Height mm	Size of Inter-changeable Stopper	Quantity Per Case	Price / Piece ₹
1662021	250	85	130	24 / 29	5	610.00
1662024	500	105	160	24 / 29	5	960.00
1662029	1000	131	195	29 / 32	5	1285.00



166P - LDPE PLASTIC WASH BOTTLES

Squeeze Type

- Fitted with delivery tubes
- Bottles and delivery tube made of chemically resistant, low density polyethylene
- Flexible, tough, light weight, and practically unbreakable in use
- Squeezing the bottle produces a steady controllable stream or a few drops.
- Delivery tubes are mounted in polypropylene screw caps
- Tips on delivery tubes are removable

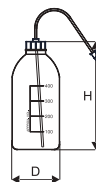

Product Code	Capacity ml	Approx Diameter mm	Bottle Height mm	Quantity Per Case	Price / Piece ₹
166024	500	75	167	36	160.00



1665 - PLASTIC CLAMPS FOR JOINT FITTINGS

- Made of polypropylene for joint fittings

Product Code	Joint mm	Quantity Per Case	Price / Piece ₹
1665B14	B 14	10	80.00
1665B19	B 19	10	80.00
1665B24	B 24	10	85.00
1665B29	B 29	10	85.00



HSN Code: 39235010



1760 - GAS WASHING (DRESCHEL) BOTTLES Set With I/C Stopper

- Complies with IS 11990
- These bottles are mechanically strong and chemical resistant
- All sizes have a durable matt-finished enamelled area for marking

Product Code	Capacity ml	Approx O.D x Height (bottle) mm	Size of Inter-changeable Stopper	Quantity Per Case Set	Price / Piece ₹
1760017	125	50 x 165	29 / 32	5	1600.00
1760021	250	60 x 190	29 / 32	5	1720.00
1760024	500	70 x 245	29 / 32	5	1970.00



1761 - STOPPER FOR GAS WASHING (DRESCHEL) BOTTLES

Product Code	Capacity ml	Quantity Per Case	Price / Piece ₹
1761017	125	5	865.00
1761021	250	5	905.00
1761024	500	5	1035.00

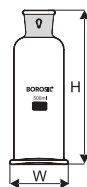

1762 - BOTTLES FOR GAS WASHING (DRESCHEL) BOTTLES

Product Code	Capacity ml	Approx O.D x Height mm	Quantity Per Case	Price / Piece ₹
1762017	125	50 x 165	5	1385.00
1762021	250	60 x 190	5	1525.00
1762024	500	70 x 245	5	1865.00

1764 - GAS SAMPLING TUBES

With Glass Stopcocks

- Complies with DIN 12473



Product Code	Capacity ml	Quantity Per Case	Price / Piece ₹
1764017	125*	10	855.00
1764021	250*	10	1005.00
1764024	500	10	1485.00
1764029	1000	10	2435.00

* Not covered in standards



1765 - IMPINGER

- Complies with IS 5182 (Part-VI)
- These bottles are mechanically strong and chemical resistant

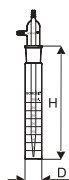

Product Code	Capacity ml	Approx O. D. x Height mm	Quantity Per Case Set	Price / Piece ₹
1765058	35	26 x 220	10	650.00



Burettes



Accuracy, reliability and durability are the three essentials of burettes offered by **BOROSIL Scientific**

Burettes are made from heavy walled, machine drawn borosilicate glass tubing, of precise bore sizes, to provide highest level of accuracy even after repeated usage.

- Complies with highest quality standards according to IS 1997 and ISO 385
- Individually calibrated on automatic calibration machines
- Available in both Class A and Class B tolerances
- Individual calibration certificate provided for Class A Burettes
- Graduation markings made using finest quality white enamel or amber ink to ensure maximum durability
- Stringent control throughout the process of manufacturing and quality checks minimizes the possibility of deviations

Made from 3.3 Low Expansion Borosilicate Glass

USP
TYPE I

TYPE I
ASTM
E438
CLASS A

ISO
3585

Please contact CT Enterprises for quotation.

Email: sales@ctenterprises.in | Phone: +91 8977721310

BOROSIL Scientific Burettes are fitted with Boroflo GP (General Purpose) stopcocks with PTFE keys keys that offers the following operational advantages :

- No lubrication required as PTFE key is used, hence no chances of contamination with grease
- Excellent flow control
- All glass/PTFE pathway which is highly resistant to chemical attack
- The unique Fluon/glass seal ensures no leakage
- No springs or retaining devices required
- Easy to dismantle and clean
- Absence of ground surfaces resulting in low absorption of radioactivity
- Consistent performance between 0°C to 50°C

In addition to Boroflo GP stopcock, **BOROSIL Scientific** also offers burettes with straight glass stopcocks and straight bore PTFE stopcocks



Burette with Boroflo GP stopcock



Burette with PTFE stopcock



Burette with Glass stopcock

- Boroflo stopcocks have PTFE keys which do not require greasing
- The PTFE keys provide best drop control during titration process
- Due to identical shape of PTFE key the Burette valve can be closed with gentle turn
- PTFE stopcocks have identical keys, hence there is no need to match pairs after cleaning
- PTFE is self lubricating hence the keys do not require greasing
- Specially designed solid glass stopcocks are manufactured from 3.3 Low expansion borosilicate glass
- Glass stopcocks are perfectly ground, for leak free operations

Please contact CT Enterprises for quotation.

Email: sales@ctenterprises.in | Phone: +91 8977721310



2121 - BURETTES

With Boroflo stopcock, Class A, with Individual Calibration Certificate

- Complies with IS 1997 / ISO 385, Accuracy as per class A
- Supplied with Boroflo stopcock
- No lubrication required
- Calibrated & certified at 27°C and supplied with certificate of calibration traceable to National standards
- Generally used in titration process

Product Code	Capacity ml	Graduation Interval ml	Tolerance \pm ml	Quantity Per Case	Price / Piece ₹
2121006	10	0.05	0.03	5	2435.00
2121U06*	10	0.05	0.02	5	2460.00
2121009	25	0.10	0.05	5	2510.00
2121U09*	25	0.10	0.03	5	2615.00
2121012	50	0.10	0.05	5	2855.00
2121016	100	0.20	0.10	5	4010.00

* Accuracy as per ASTM E287-2 and calibrated at 20°C
50 ml and 100 ml capacities complies both standards - ISO and ASTM for accuracy

2122 - BURETTES

With Boroflo stopcock, Class B

- Complies with IS 1997 / ISO 385, Accuracy as per class B
- Supplied with Boroflo stopcock
- No lubrication required
- Calibrated at 27°C
- Generally used in titration process

Product Code	Capacity ml	Graduation Interval ml	Tolerance \pm ml	Quantity Per Case	Price / Piece ₹
2122006	10	0.05	0.05	10	790.00
2122009	25	0.10	0.10	10	750.00
2122012	50	0.10	0.10	5	830.00
2122016	100	0.20	0.20	5	1255.00

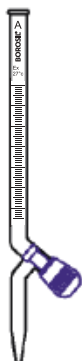

2123 - BURETTES

With Glass stopcock, Class A, with Individual Calibration Certificate

- Complies with IS 1997 / ISO 385, Accuracy as per class A
- Designed with straight bore stopcock that increases the life, compared to Boroflo stopcocks
- The glass stopcock enhances control and enables smoother action
- Calibrated & certified at 27°C and supplied with certificate of calibration traceable to National standards
- Generally used in Titration process

Product Code	Capacity ml	Graduation Interval ml	Tolerance \pm ml	Quantity Per Case	Price / Piece ₹
2123005	5	0.02	0.01	5	2610.00
2123006	10	0.05	0.03	5	2750.00
2123009	25	0.10	0.05	5	2705.00
2123012	50	0.10	0.05	5	3075.00
2123016	100	0.20	0.10	5	4430.00

2124 - BURETTES

With Glass stopcock, Class B

- Complies with IS 1997 / ISO 385, Accuracy as per class B
- Designed with straight bore stopcock that increases the life, compared to Boroflo stopcocks
- The glass stopcock enhances control and enables smoother action
- Calibrated at 27°C
- Generally used in Titration process

Product Code	Capacity ml	Graduation Interval ml	Tolerance \pm ml	Quantity Per Case	Price / Piece ₹
2124005	5	0.02	0.02	5	1055.00
2124006	10	0.05	0.05	10	900.00
2124009	25	0.10	0.10	10	875.00
2124012	50	0.10	0.10	5	950.00
2124016	100	0.20	0.20	5	1330.00





2129 - BURETTES

With PTFE stopcock, Class A, with Individual Calibration Certificate

- Complies with IS 1997 / ISO 385, Accuracy as per class A
- Supplied with PTFE stopcock that is highly resistant to chemical attack
- No lubrication required
- Calibrated & certified at 27°C and supplied with certificate of calibration traceable to National standards
- Generally used in Titration process

Product Code	Capacity ml	Graduation Interval ml	Tolerance \pm ml	Quantity Per Case	Price / Piece ₹
2129012	50	0.1	0.05	5	3075.00

Burettes of other capacities are on request

2130 - BURETTES

With PTFE stopcock, Class B

- Complies with IS 1997 / ISO 385, Accuracy as per class B
- Supplied with PTFE stopcock that is highly resistant to chemical attack
- No lubrication required
- Calibrated at 27°C
- Generally used in Titration process

Product Code	Capacity ml	Graduation Interval ml	Tolerance \pm ml	Quantity Per Case	Price / Piece ₹
2130012	50	0.1	0.1	5	1140.00



2131 - BURETTES

With Boroflo stopcock, Class A, Amber, with Individual Calibration Certificate

- Complies with IS 1997 / ISO 385, Accuracy as per class A
- Supplied with Boroflo stopcock
- No lubrication required
- Calibrated & certified at 27°C and supplied with certificate of calibration traceable to National standards
- Amber coating on exterior surfaces to facilitate use with light sensitive solutions
- Generally used in titration process

Product Code	Capacity ml	Graduation Interval ml	Tolerance \pm ml	Quantity Per Case	Price / Piece ₹
2131009	25	0.10	0.05	5	4140.00
2131012	50	0.10	0.05	5	4585.00

2132 - BURETTES

With Boroflo stopcock, Class B, Amber

- Complies with IS 1997 / ISO 385, Accuracy as per class B
- Supplied with Boroflo stopcock
- No lubrication required
- Calibrated at 27°C
- Amber coating on exterior surfaces to facilitate use with light sensitive solutions
- Generally used in titration process

Product Code	Capacity ml	Graduation Interval ml	Tolerance \pm ml	Quantity Per Case	Price / Piece ₹
2132009	25	0.10	0.10	10	1205.00
2132012	50	0.10	0.10	5	1325.00

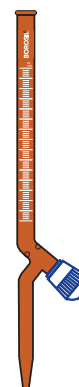

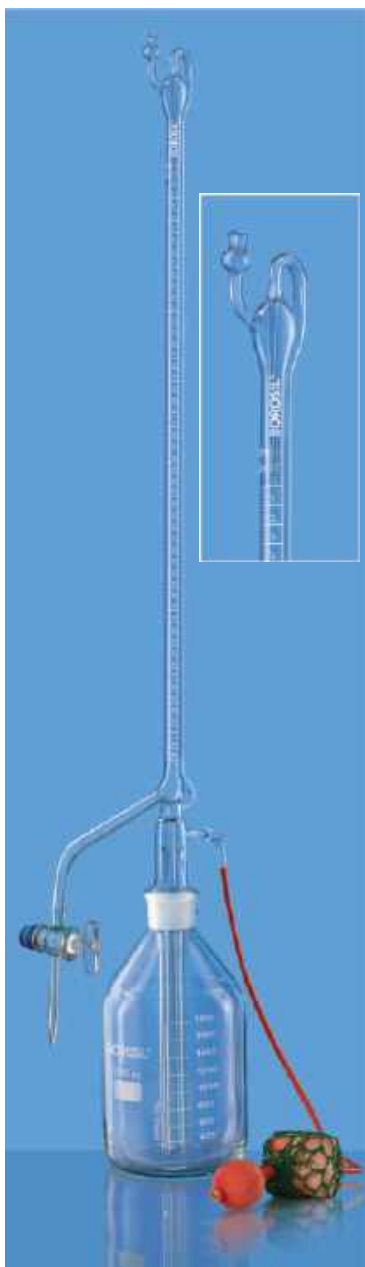

2149 - AUTOBURETTES

With Glass stopcock, Class A, with Individual Calibration Certificate

- Complies with IS 1997 / ISO 385, Accuracy as per class A
- Supplied with Reservoir and Rubber Bellow
- With automatic zero facility
- Calibrated & certified at 27°C and supplied with certificate of calibration traceable to National standards
- Generally used in Titration process

Product Code	Capacity ml	Graduation Interval ml	Tolerance \pm ml	Quantity Per Case	Price / Piece ₹
2149006	10	0.05	0.03	1	10410.00
2149009	25	0.10	0.05	1	10080.00
2149012	50	0.10	0.05	1	11270.00
2149016	100	0.20	0.10	1	12830.00

Reservoir Capacity : 500 ml for 10 ml size and 2000 ml for 25, 50 and 100 ml sizes.

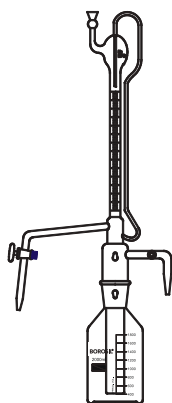

2150 - AUTOBURETTES

With Glass stopcock, Class B

- Complies with IS 1997 / ISO 385, Accuracy as per class B
- Supplied with Reservoir and Rubber Bellow
- With automatic zero facility
- Calibrated at 27°C
- Generally used in Titration process

Product Code	Capacity ml	Graduation Interval ml	Tolerance \pm ml	Quantity Per Case	Price / Piece ₹
2150006	10	0.05	0.05	1	6835.00
2150009	25	0.10	0.10	1	6720.00
2150012	50	0.10	0.10	1	7280.00
2150016	100	0.20	0.20	1	8295.00

Reservoir Capacity : 500 ml for 10 ml size and 2000 ml for 25, 50 and 100 ml sizes.

2149A - AUTOBURETTES

With Glass stopcock, Class A, Amber, with Individual Calibration Certificate

- Complies with IS 1997 / ISO 385, Accuracy as per class A
- Supplied with Reservoir and Rubber Bellow
- With automatic zero facility
- Calibrated & certified at 27°C and supplied with certificate of calibration traceable to National standards
- Amber coating on exterior surfaces to facilitate use with light sensitive solutions
- Generally used in Titration process

Product Code	Capacity ml	Graduation Interval ml	Tolerance \pm ml	Quantity Per Case	Price / Piece ₹
2149A06	10	0.05	0.03	1	21410.00
2149A09	25	0.10	0.05	1	22700.00
2149A12	50	0.10	0.05	1	24975.00
2149A16	100	0.20	0.10	1	25800.00

Reservoir Capacity : 500 ml for 10 ml size and 2000 ml for 25, 50 and 100 ml sizes.

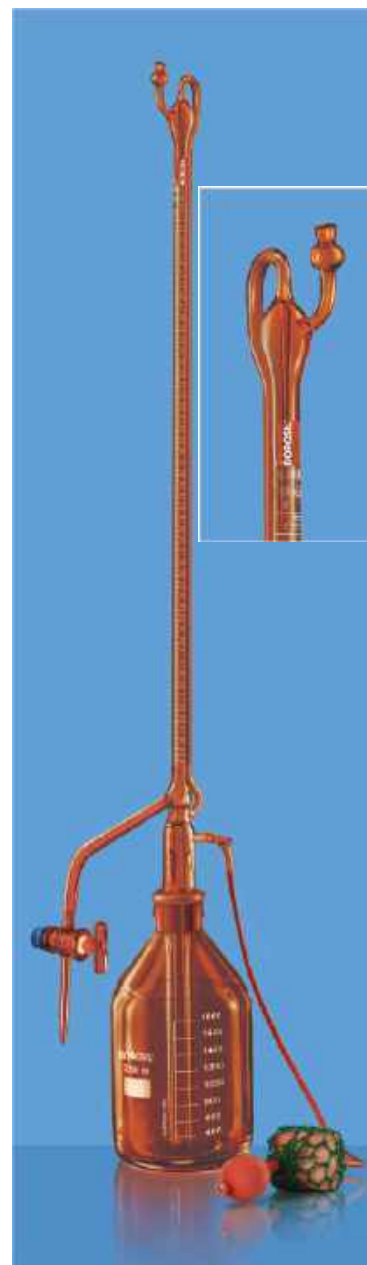
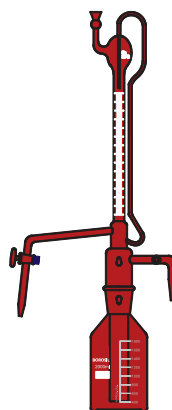

2150A - AUTOBURETTES

With Glass stopcock, Class B, Amber

- Complies with IS 1997 / ISO 385, Accuracy as per class B
- Supplied with Reservoir and Rubber Bellow
- With automatic zero facility
- Calibrated at 27°C
- Amber coating on exterior surfaces to facilitate use with light sensitive solutions
- Generally used in Titration process

Product Code	Capacity ml	Graduation Interval ml	Tolerance \pm ml	Quantity Per Case	Price / Piece ₹
2150A06	10	0.05	0.05	1	14930.00
2150A09	25	0.10	0.10	1	15150.00
2150A12	50	0.10	0.10	1	15455.00
2150A16	100	0.20	0.20	1	16210.00

Reservoir Capacity : 500 ml for 10 ml size and 2000 ml for 25, 50 and 100 ml sizes.



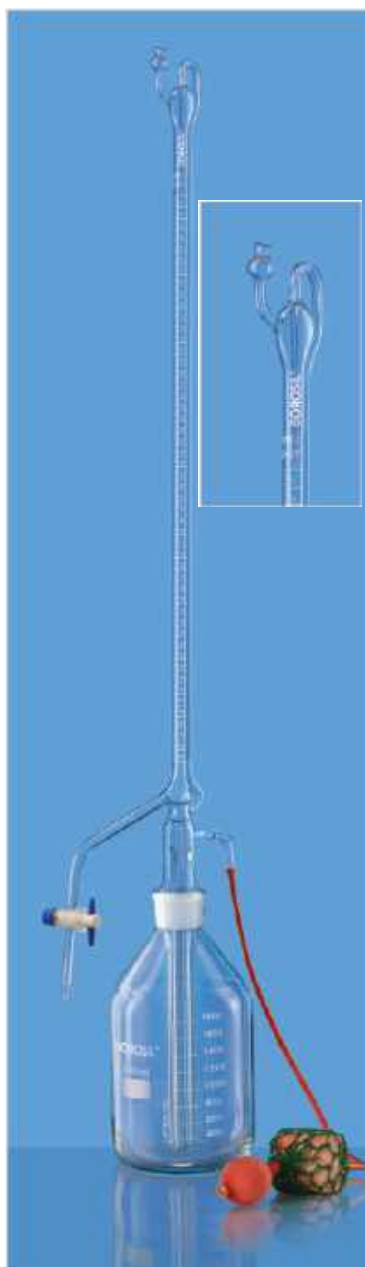

2153 - AUTOBURETTES

With PTFE Stopcock, Class A, with Individual Calibration Certificate

- Complies with IS 1997 / ISO 385, Accuracy as per class A
- Supplied with PTFE stopcock that is highly resistant to chemical attack
- Supplied with Reservoir and Rubber Bellow
- With automatic zero facility
- Calibrated & certified at 27°C and supplied with certificate of calibration traceable to National standards
- Generally used in titration process

Product Code	Capacity ml	Graduation Interval ml	Tolerance \pm ml	Quantity Per Case	Price / Piece ₹
2153006	10	0.05	0.03	1	10980.00
2153009	25	0.10	0.05	1	10735.00
2153012	50	0.10	0.05	1	11905.00
2153016	100	0.20	0.10	1	13610.00

Reservoir Capacity : 500 ml for 10 ml size and 2000 ml for 25, 50 and 100 ml sizes.

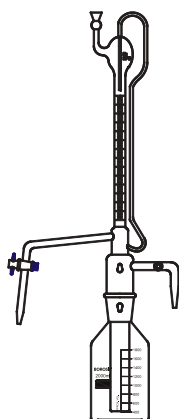

2154 - AUTOBURETTES

With PTFE stopcock, Class B

- Complies with IS 1997 / ISO 385, Accuracy as per class B
- Supplied with PTFE stopcock that is highly resistant to chemical attack
- Supplied with Reservoir and Rubber Bellow
- With automatic zero facility
- Calibrated at 27°C
- Generally used in titration process

Product Code	Capacity ml	Graduation Interval ml	Tolerance \pm ml	Quantity Per Case	Price / Piece ₹
2154006	10	0.05	0.05	1	7205.00
2154009	25	0.10	0.10	1	7055.00
2154012	50	0.10	0.10	1	7665.00
2154016	100	0.20	0.20	1	8700.00

Reservoir Capacity : 500 ml for 10 ml size and 2000 ml for 25, 50 and 100 ml sizes.

2153A - AUTOBURETTES

With PTFE stopcock, Class A, Amber, with Individual Calibration Certificate

- Complies with IS 1997 / ISO 385, Accuracy as per class A
- Supplied with PTFE stopcock that is highly resistant to chemical attack
- Supplied with Reservoir and Rubber Bellow
- With automatic zero facility
- Calibrated & certified at 27°C and supplied with certificate of calibration traceable to National standards
- Amber coating on exterior surfaces to facilitate use with light sensitive solutions
- Generally used in titration process

Product Code	Capacity ml	Graduation Interval ml	Tolerance \pm ml	Quantity Per Case	Price / Piece ₹
2153A06	10	0.05	0.03	1	22205.00
2153A09	25	0.10	0.05	1	23700.00
2153A12	50	0.10	0.05	1	25955.00
2153A16	100	0.20	0.10	1	27160.00

Reservoir Capacity : 500 ml for 10 ml size and 2000 ml for 25, 50 and 100 ml sizes.

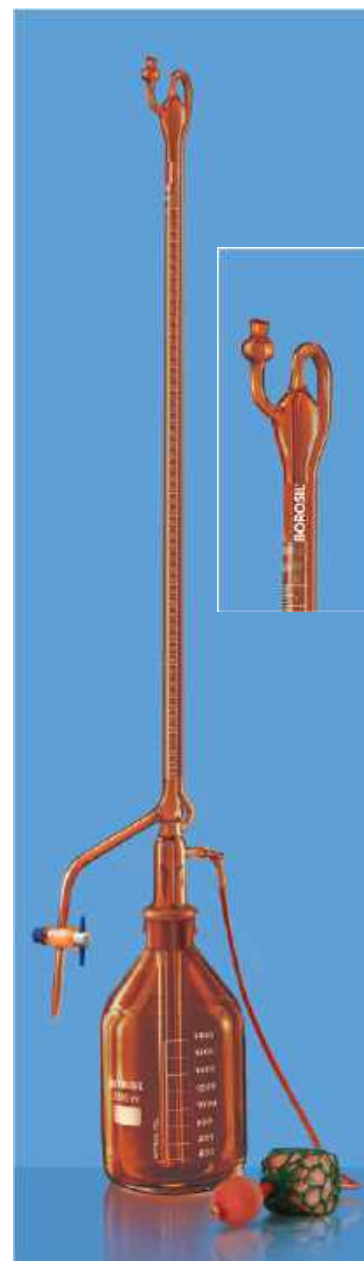
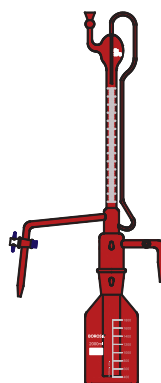

2154A - AUTOBURETTES

With PTFE stopcock, Class B, Amber

- Complies with IS 1997 / ISO 385, Accuracy as per class B
- Supplied with PTFE stopcock that is highly resistant to chemical attack
- Supplied with Reservoir and Rubber Bellow
- With automatic zero facility
- Calibrated at 27°C
- Amber coating on exterior surfaces to facilitate use with light sensitive solutions
- Generally used in titration process

Product Code	Capacity ml	Graduation Interval ml	Tolerance \pm ml	Quantity Per Case	Price / Piece ₹
2154A06	10	0.05	0.05	1	15150.00
2154A09	25	0.10	0.10	1	14250.00
2154A12	50	0.10	0.10	1	14630.00
2154A16	100	0.20	0.20	1	15300.00

Reservoir Capacity : 500 ml for 10 ml size and 2000 ml for 25, 50 and 100 ml sizes.





2155 - AUTOBURETTES

With Boroflo stopcock, Class A, with Individual Calibration Certificate

- Complies with IS 1997 / ISO 385, Accuracy as per class A
- Supplied with Boroflo stopcock, Reservoir and Rubber Bellow
- With automatic zero facility
- Calibrated & certified at 27°C and supplied with certificate of calibration traceable to National standards
- Generally used in titration process

Product Code	Capacity ml	Graduation Interval ml	Tolerance ± ml	Quantity Per Case	Price / Piece ₹
2155006	10	0.05	0.03	1	10055.00
2155009	25	0.10	0.05	1	9795.00
2155012	50	0.10	0.05	1	10880.00
2155016	100	0.20	0.10	1	12365.00

Reservoir Capacity : 500 ml for 10 ml size and 2000 ml for 25, 50 and 100 ml sizes.

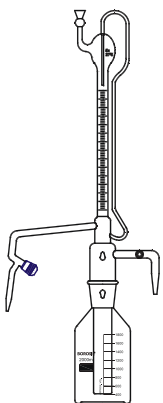

2156 - AUTOBURETTES

With Boroflo stopcock, Class B

- Complies with IS 1997 / ISO 385, Accuracy as per class B
- Supplied with Boroflo stopcock, Reservoir and Rubber Bellow
- With automatic zero facility
- Calibrated at 27°C
- Generally used in titration process

Product Code	Capacity ml	Graduation Interval ml	Tolerance ± ml	Quantity Per Case	Price / Piece ₹
2156006	10	0.05	0.05	1	6645.00
2156009	25	0.10	0.10	1	6495.00
2156012	50	0.10	0.10	1	7115.00
2156016	100	0.20	0.20	1	8165.00

Reservoir Capacity : 500 ml for 10 ml size and 2000 ml for 25, 50 and 100 ml sizes.

2155A - AUTOBURETTES

With Boroflo stopcock, Class A, Amber, with Individual Calibration Certificate

- Complies with IS 1997 / ISO 385, Accuracy as per class A
- Supplied with Boroflo stopcock, Reservoir and Rubber Bellow
- With automatic zero facility
- Amber coating on exterior surfaces to facilitate use with light sensitive solutions
- Calibrated & certified at 27°C and supplied with certificate of calibration traceable to National standards
- Generally used in titration process

Product Code	Capacity ml	Graduation Interval ml	Tolerance \pm ml	Quantity Per Case	Price / Piece ₹
2155A06	10	0.05	0.03	1	21155.00
2155A09	25	0.10	0.05	1	22350.00
2155A12	50	0.10	0.05	1	24830.00
2155A16	100	0.20	0.10	1	25650.00

Reservoir Capacity : 500 ml for 10 ml size and 2000 ml for 25, 50 and 100 ml sizes.

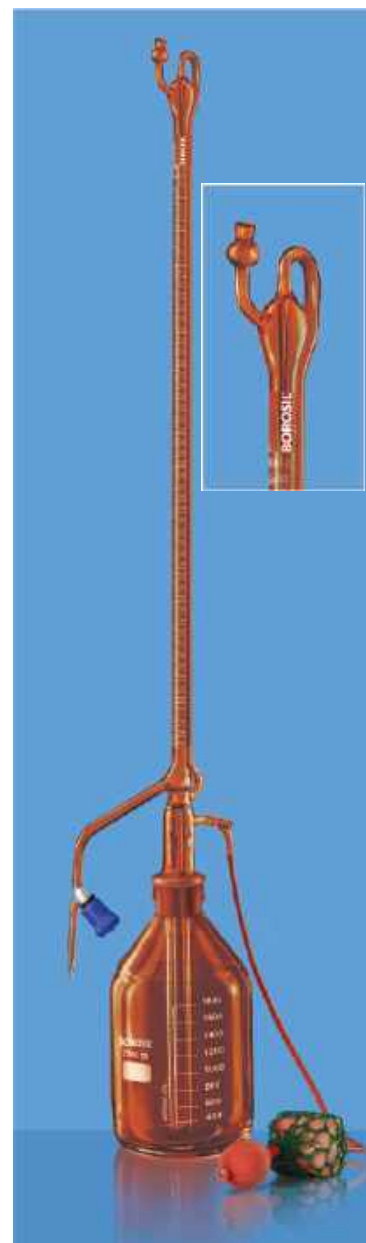
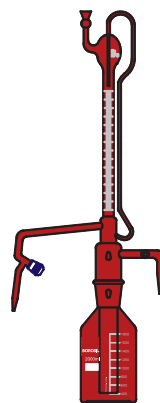

2156A - AUTOBURETTES

With Boroflo stopcock, Class B, Amber

- Complies with IS 1997 / ISO 385, Accuracy as per class B
- Supplied with Boroflo stopcock, Reservoir and Rubber Bellow
- With automatic zero facility
- Calibrated at 27°C
- Amber coating on exterior surfaces to facilitate use with light sensitive solutions
- Generally used in titration process

Product Code	Capacity ml	Graduation Interval ml	Tolerance \pm ml	Quantity Per Case	Price / Piece ₹
2156A06	10	0.05	0.05	1	14780.00
2156A09	25	0.10	0.10	1	14930.00
2156A12	50	0.10	0.10	1	15380.00
2156A16	100	0.20	0.20	1	15975.00

Reservoir Capacity : 500 ml for 10 ml size and 2000 ml for 25, 50 and 100 ml sizes.



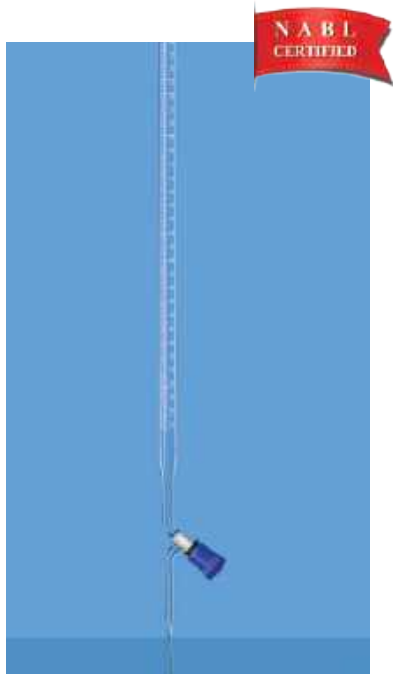

2000 - BURETTES

With Boroflo stopcock, NABL Certified, Class A, with Individual Calibration Certificate

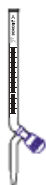

- Complies with IS 1997 / ISO 385, Accuracy as per class A
- Supplied with Boroflo stopcock
- No lubrication required
- Calibrated & certified at 27°C and supplied with NABL certificate of calibration traceable to National standards
- Generally used in titration process

Product Code	Capacity ml	Graduation Interval ml	Tolerance \pm ml	Quantity Per Case	Price / Piece ₹
2000006	10	0.05	0.03	1	4890.00
2000009	25	0.10	0.05	1	5065.00
2000012	50	0.10	0.05	1	5720.00
2000016	100	0.20	0.10	1	8035.00

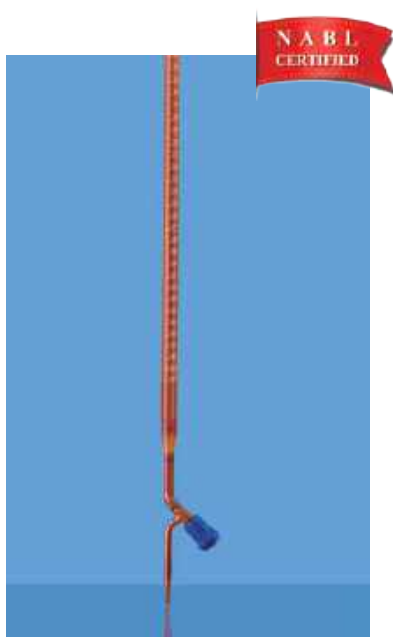

2001 - BURETTES

With Boroflo stopcock, NABL Certified, Class A, Amber, with Individual Calibration Certificate



- Complies with IS 1997 / ISO 385, Accuracy as per class A
- Supplied with Boroflo stopcock
- No lubrication required
- Calibrated & certified at 27°C and supplied with NABL certificate of calibration traceable to National standards
- Amber coating on exterior surfaces to facilitate use with light sensitive solutions
- Generally used in titration process

Product Code	Capacity ml	Graduation Interval ml	Tolerance \pm ml	Quantity Per Case	Price / Piece ₹
2001009	25	0.1	0.05	1	7755.00
2001012	50	0.1	0.05	1	8795.00

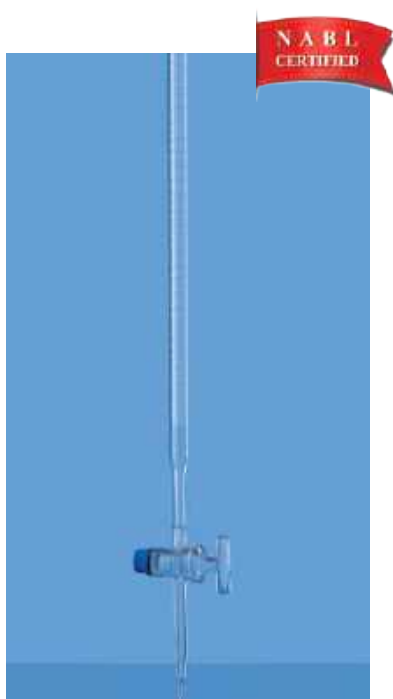

2002 - BURETTES

With Glass stopcock, NABL Certified, Class A, with Individual Calibration Certificate



- Complies with IS 1997 / ISO 385, Accuracy as per class A
- Designed with straight bore stopcock that increases the life, compared to PTFE key stopcocks
- The glass stopcock enhances control and enables smoother action
- Calibrated & certified at 27°C and supplied with NABL certificate of calibration traceable to National standards
- Generally used in titration process

Product Code	Capacity ml	Graduation Interval ml	Tolerance \pm ml	Quantity Per Case	Price / Piece ₹
2002006	10	0.05	0.03	1	5035.00
2002009	25	0.10	0.05	1	5215.00
2002012	50	0.10	0.05	1	5955.00
2002016	100	0.20	0.10	1	8480.00

Laboratory
Accessories
For safer experiments



Please contact CT Enterprises for quotation.

Email: sales@ctenterprises.in | Phone: +91 8977721310

page no. 214-223

Cones

Cones are used to determine small amounts of suspended matter in sewage by the Imhoff Sedimentation Method.

Made from 3.3 Low Expansion Borosilicate Glass



Please contact CT Enterprises for quotation.

Email: sales@ctenterprises.in | Phone: +91 8977721310

2160 - IMHOFF CONE

Sharp Tip

- Complies with IS 7232
- Graduated from 0 to 1 ml in 0.1 ml divisions
- Graduated from 1 to 10 ml in 0.5 ml divisions
- 10 to 40 ml in 1 ml divisions also marked at 1000 ml
- Facilitates the determination of the amount of sediment in sewage or industrial waste

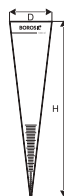

Product Code	Approx Total Height mm	Approx Top Diameter mm	Quantity Per Case	Price / Piece ₹
2160094	454	110	1	7130.00

2180 - IMHOFF CONE

Blunt Tip

- Complies with IS 7232
- The blunt tip increases its ruggedness and cleaning ease
- Ideal for use with heavy sediments where the ability to read small volumes is unimportant
- Facilitates the determination of the amount of sediment in sewage or industrial waste



Product Code	Approx Total Height mm	Approx Top Diameter mm	Quantity Per Case	Price / Piece ₹
2180093	439	110	1	7275.00

Condensers

A Condenser is designed to facilitate the cooling of hot vapours and liquids. It is structured in the form of a large glass tube, containing a smaller glass tube running through its entire length. Hot fluids pass through this small inner tube.

Typically, the outer glass tube has two hose connections to aid the passing of a coolant (usually tap water or chilled water/anti-freeze mixture). The coolant is introduced through the lower fitting, while the higher fitting serves as the exit point. Entering the coolant at the cooler point is a critical aspect as it helps maintain a smooth and correctly directed thermal gradient. This in turn, maximises efficiency and minimises the risk of thermal shock to adjacent glassware. Multiple Condensers may be connected in a series. Usually, a high flow rate is not essential for maintaining a cooling surface.

Special care should be taken while choosing Condensers keeping in mind their distillation rates, reflux rates and temperature gradients.

Borosil offers you the choice of a wide range of Condensers.

Made from 3.3 Low Expansion
Borosilicate Glass

USP
TYPE I

TYPE I
ASTM
E438
CLASS A

ISO
3585



Please contact CT Enterprises for quotation.

Email: sales@ctenterprises.in | Phone: +91 8977721310

2340 - LIEBIG CONDENSER

With Sealed Inner Tube

- Complies with IS 6052
- The light wall of the inner tube facilitates efficient heat transfer
- Low cooling capacity
- Used for distillate separation

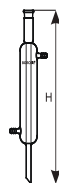

Product Code	Approx Jacket Length mm	Approx Overall Height mm	Ground Joint	Quantity Per Case	Price / Piece ₹
2340087	200	350	19 / 26	5	735.00
2340090	300	450	19 / 26	5	625.00
2340092	400	550	19 / 26	5	650.00
2340095	500	650	19 / 26	5	795.00



- Condensers
- Cylinders
- Hydrometers
- Desiccators

2400 - LIEBIG CONDENSER

With Drip Tip

- Complies with IS 6052
- With interchangeable inner and outer joints
- The light wall of the inner tube facilitates efficient heat transfer
- Low cooling capacity
- Used for distillate separation

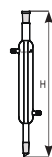

Product Code	Approx Jacket Length mm	Approx Overall Height mm	Ground Joint		Quantity Per Case	Price / Piece ₹
			Socket	Cone		
2400087	200	350	19 / 26	19 / 26	5	735.00
2400A87	200	350	24 / 29	24 / 29	5	735.00
2400090	300	450	24 / 29	24 / 29	5	810.00
2400A90	300	450	19 / 26	19 / 26	5	810.00
2400092	400	550	24 / 29	24 / 29	5	940.00
2400A92	400	550	29 / 32	29 / 32	5	940.00
2400B92	400	550	19 / 26	19 / 26	5	940.00

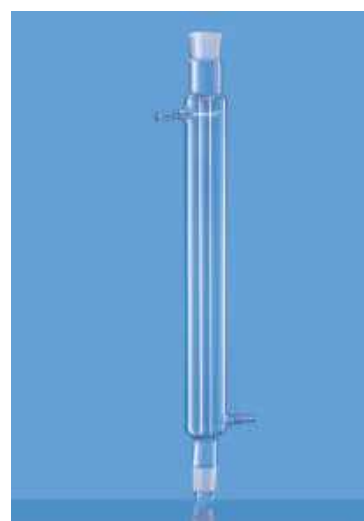

2480 - ALLIHN CONDENSER

With Drip Tip

- Complies with IS 6052
- With Interchangeable Inner and Outer Joint
- Greater surface area than the Liebig Condenser owing to a series of bulbs, resulting in higher cooling capacity
- Ideal for laboratory scale refluxing

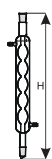

Product Code	Approx Jacket Length mm	Approx Overall Height mm	Ground Joint		Quantity Per Case	Price / Piece ₹
			Socket	Cone		
2480087	200	350	19 / 26	19 / 26	5	940.00
2480A87	200	350	24 / 29	24 / 29	5	940.00
2480090	300	450	24 / 29	24 / 29	5	985.00
2480A90	300	450	19 / 26	19 / 26	5	985.00
2480092	400	550	24 / 29	24 / 29	5	1145.00
2480A92	400	550	29 / 32	29 / 32	5	1145.00
2480096	600	750	29 / 32	29 / 32	5	1550.00
2480A96	600	750	24 / 29	24 / 29	5	1550.00



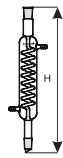

2560 - GRAHAM COILED CONDENSER With Drip Tip

- Complies with IS 6052
- With Interchangeable Inner and Outer Joint
- The coiled condensation tubes result in greater surface area for cooling
- Designed with top standard taper outer and lower inner drip tip joint

Product Code	Approx Jacket Length mm	Approx Overall Height mm	Ground Joint		Quantity Per Case	Price / Piece ₹
			Socket	Cone		
2560090	300	450	24 / 29	24 / 29	5	1130.00
2560A90	300	450	19 / 26	19 / 26	5	1130.00
2560092	400	550	24 / 29	24 / 29	5	1160.00
2560A92	400	550	29 / 32	29 / 32	5	1160.00
2560095	500	650	24 / 29	24 / 29	5	1460.00
2560A95	500	650	29 / 32	29 / 32	5	1460.00

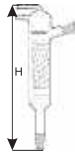

2640 - FRIEDRICH CONDENSER With Drip Tip

- Complies with IS 6052
- With Interchangeable Inner and Outer Joint
- Specially designed inner spiral tubes ensure along vapour path
- Offer better heat transfer and anti-flooding capabilities

Product Code	Approx Jacket Length mm	Ground Joint		Quantity Per Case	Price / Piece ₹
		Socket	Cone		
2640097	350	24 / 29	24 / 29	5	4530.00



2641 - DOUBLE SURFACE CONDENSER

- Complies with IS 6052

Product Code	Approx Jacket Length mm	Approx Overall Height mm	Ground Joint	Quantity Per Case	Price / Piece ₹
2641087	200	345	19 / 26	5	2880.00
2641187	200	360	24 / 29	5	3070.00
2641090	300	454	19 / 26	5	3795.00
2641190	300	450	24 / 29	5	4155.00

The above condensers are widely used in research labs. A double-surface condenser has a water jacket both on the outside and through the centre of the condensing tube. It is needed where the condensed liquid is very volatile. Hence for distilling ethers, alcohols, esters, aromatics, petroleum products and essential oils these condensers are widely used.

Temperature controlled Heating Mantles

Temperature Controlled Heating Mantles are indispensable tools in the laboratory. The equipment precisely fits the boiling and distillation flask, round bottom flasks, or relevant reaction vessels, providing consistent and controllable heating of organic liquids required for the boiling, evaporation, distillation, or extraction process. With their advanced temperature control capabilities, Heating Mantles ensure optimal conditions for various scientific procedures, enhancing efficiency and accuracy in experimentation.

The Integrated PID control for better temperature accuracy & Integrated retort rod holder for space saving apparatus assembly.

- It also Includes PT 100 external temperature probe with auto detection on plug in and is able to monitor reaction times exclusively.
- Automatic spill detection and safety shutdown, protective fuse.
- Built in temperature calibration and, safe temperature setting
- Visit our CE Certified GMC series Mantles page no. 318

Call or Write to us

Email id: lab.support@borosil.com
Toll Free Number: 1800 224 551



Cylinders

Measuring cylinders are the most common and essential measuring devices used in any laboratory. **BOROSIL Scientific** Cylinders are made from heavy walled, machine drawn borosilicate glass tubing which makes them sturdy for daily laboratory use.

BOROSIL Scientific offers cylinders from capacities 5ml to 2000ml, with penny head stoppers.



Made from 3.3 Low Expansion
Borosilicate Glass



Please contact CT Enterprises for quotation.

Email: sales@ctenterprises.in | Phone: +91 8977721310

- Complies with highest quality standards according to IS 878, ASTM E1272 and ISO 4788
- All measuring cylinders are calibrated to contain (TC, In) and all tolerances are according to IS/ISO/DIN/ASTM class "A" Standards
- Individually calibrated on automatic calibration machine
- Available in both Class A and Class B tolerances
- Individual calibration certificate provided for Class A pipettes
- Graduation markings made using finest quality white enamel or amber ink to ensure maximum durability
- Stringent control throughout the process of manufacturing and quality checks minimizes the possibility of deviations
- Specially designed with hexagonal base for enhance stability
- Spout allows drip free pouring

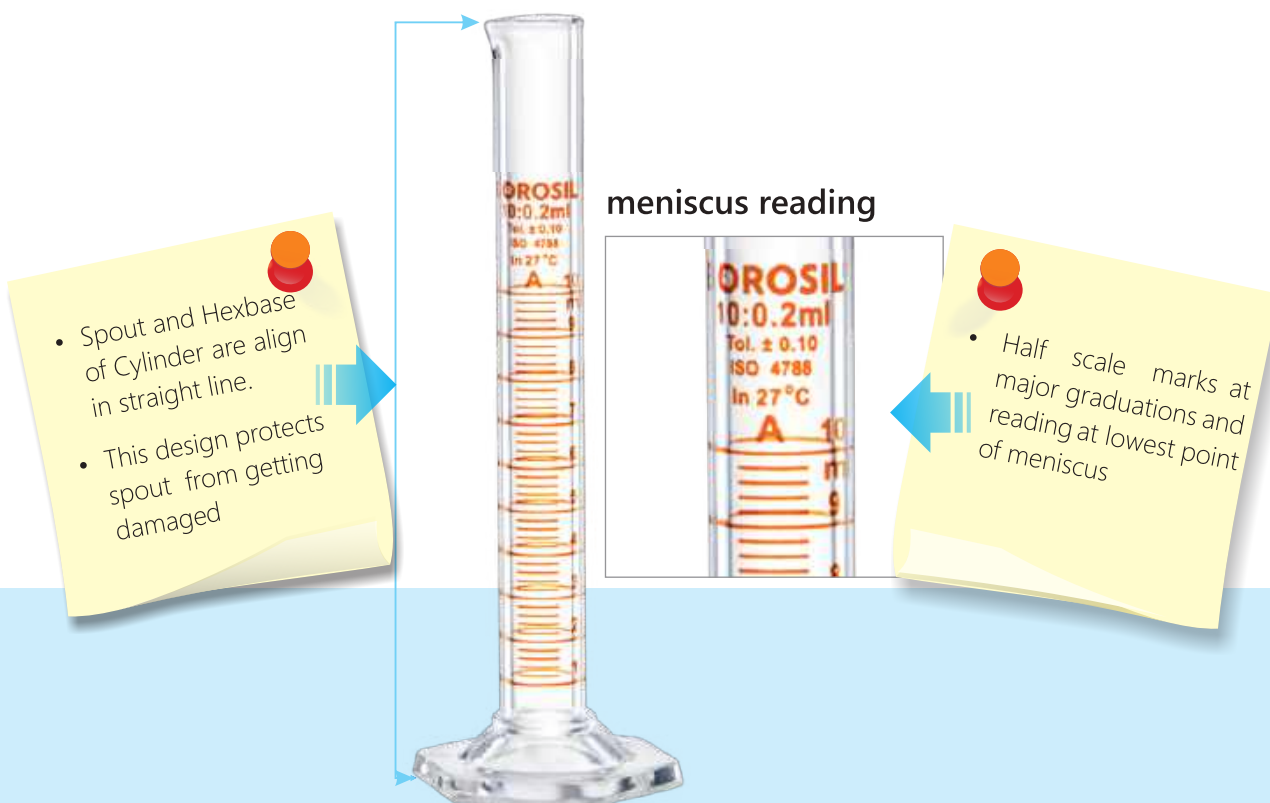

Please contact CT Enterprises for quotation.

Email: sales@ctenterprises.in | Phone: +91 8977721310



2975 - NESSLER CYLINDERS

- Complies with IS 4161
- Facilitates colour comparison of water samples, freedom from colour or visible defects
- White enamel inscriptions
- Calibrated at 27°C

Product Code	Capacity ml	Approx O.D. x Height	Tolerance \pm ml	Quantity Per Case	Price / Piece ₹
2975009	25	19 x 165	0.20	10	225.00
2975012	50	25 x 150	0.40	20	240.00
2975016	100	34 x 180	0.80	30	350.00



2981 - CYLINDERS

Class A, Hexagonal Base, with I/C Stopper, with Individual Calibration Certificate

- Complies with IS 878, ISO 4788 **with ISI Mark**
- Supplied with Interchangeable Penny head Stopper
- Graduated, Single Metric Scale
- Each cylinder is engraved with a unique serial number, and comes with a Certificate of Calibration traceable to national standards
- Graduations in amber enamel
- Sturdy hexagonal base prevents roll-over and ensures greater stability
- Calibrated and certified at 27°C

Product Code	Capacity ml	Graduation Interval ml	Tolerance \pm ml	Stopper Size	Quantity Per Case	Price / Piece ₹
2981005	5	0.1	0.05	10 / 19	5	985.00
2981006	10	0.2	0.10	10 / 19	5	1085.00
2981009	25	0.5	0.25	14 / 23	10	1245.00
2981012	50	1	0.50	14 / 23	10	1415.00
2981016	100	1	0.50	19 / 26	10	1655.00
2981021	250	2	1	24 / 29	5	2595.00
2981024	500	5	2.5	24 / 29	5	3335.00
2981029	1000	10	5	34 / 35	4	4080.00
2981030	2000	20	10	34 / 35	4	6490.00

2982 - CYLINDERS

Class B, Hexagonal Base, with I/C Stopper

- Complies with IS 878, ISO 4788 **with ISI Mark**
- Supplied with Interchangeable Penny head Stopper
- Graduated, Single Metric Scale
- Graduations in amber enamel
- Sturdy hexagonal base prevents roll-over and ensures greater stability
- Calibrated at 27°C



Product Code	Capacity ml	Graduation Interval ml	Tolerance \pm ml	Stopper Size	Quantity Per Case	Price / Piece ₹
2982005	5	0.1	0.1	10 / 19	5	535.00
2982006	10	0.2	0.2	10 / 19	5	565.00
2982009	25	0.5	0.5	14 / 23	10	635.00
2982012	50	1	1	14 / 23	10	715.00
2982016	100	1	1	19 / 26	10	875.00
2982021	250	2	2	24 / 29	10	1485.00
2982024	500	5	5	24 / 29	5	2065.00
2982029	1000	10	10	34 / 35	4	2975.00
2982030	2000	20	20	34 / 35	4	5145.00

2983 - CYLINDERS

USP, Class A, Hexagonal Base, with I/C Stopper, with Individual Calibration Certificate

- Tolerance complies with ASTM E 1272 and dimension as per ISO 4788
- Supplied with Interchangeable Penny head Stopper
- Graduated, Single Metric Scale
- Each cylinder is engraved with a unique serial number, and comes with a Certificate of Calibration traceable to national standards
- Graduations in amber enamel
- Sturdy hexagonal base prevents roll-over and ensures greater stability
- Calibrated and certified at 20°C



Product Code	Capacity ml	Graduation Interval ml	Tolerance \pm ml	Stopper Size	Quantity Per Case	Price / Piece ₹
2983005	5	0.1	0.05	10 / 19	5	1030.00
2983006	10	0.2	0.10	10 / 19	5	1185.00
2983009	25	0.5	0.17	14 / 23	10	1335.00
2983012	50	1	0.25	14 / 23	10	1590.00
2983016	100	1	0.50	19 / 26	10	1775.00
2983021	250	2	1	24 / 29	5	2860.00
2983024	500	5	2	24 / 29	5	3405.00
2983029	1000	10	3	34 / 35	4	4195.00
2983030	2000	20	6	34 / 35	4	7870.00

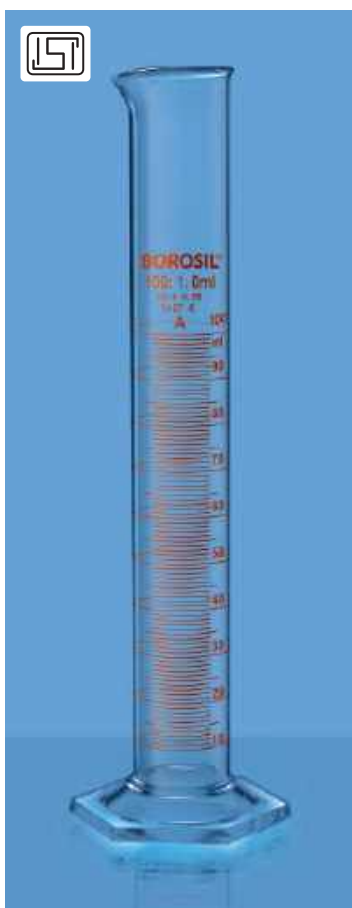

3021 - CYLINDERS

Class A, Hexagonal base, Pour out, with Individual Calibration Certificate

- Complies with IS 878, ISO 4788 **with ISI Mark**
- Graduated, Single Metric Scale
- Each cylinder is engraved with a unique serial number, and comes with a Certificate of Calibration traceable to national standards
- Graduations in amber enamel
- Sturdy hexagonal base prevents roll-over and ensures greater stability
- Calibrated and certified at 27°C

Product Code	Capacity ml	Graduation Interval ml	Tolerance \pm ml	Quantity Per Case	Price / Piece ₹
3021005	5	0.1	0.05	5	580.00
3021006	10	0.2	0.1	5	670.00
3021008	20*	0.1	0.25	10	850.00
3021009	25	0.5	0.25	10	765.00
3021012	50	1	0.5	10	930.00
3021016	100	1	0.5	10	1055.00
3021018	150*	2	1	5	1400.00
3021021	250	2	1	10	1555.00
3021024	500	5	2.5	5	2170.00
3021029	1000	10	5	4	2645.00
3021030	2000	20	10	4	5150.00

* As per Borosil Scientific standards.

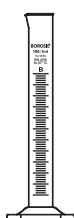
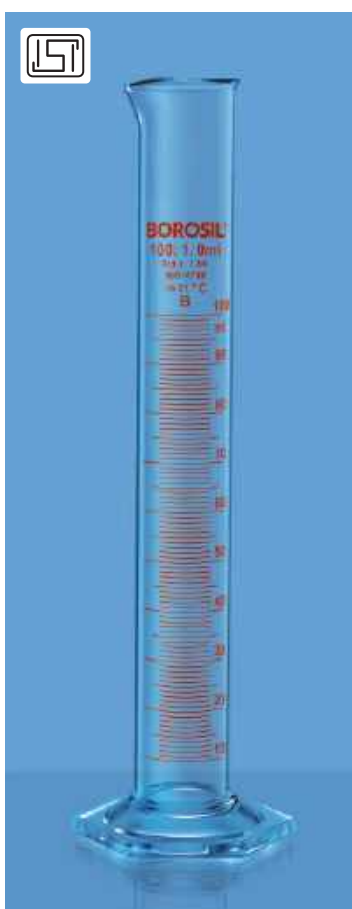

3022 - CYLINDERS

Class B, Hexagonal base, Pour out

- Complies with IS 878, ISO 4788 **with ISI Mark**
- Graduated, Single Metric Scale
- Certificate of Calibration traceable to national standards
- Graduations in amber enamel
- Sturdy hexagonal base prevents roll-over and ensures greater stability
- Calibrated at 27°C

Product Code	Capacity ml	Graduation Interval ml	Tolerance \pm ml	Quantity Per Case	Price / Piece ₹
3022005	5	0.1	0.1	5	325.00
3022006	10	0.2	0.2	5	390.00
3022009	25	0.5	0.5	10	450.00
3022012	50	1	1	20	495.00
3022016	100	1	1	20	555.00
3022018	150*	2	2	5	825.00
3022021	250	2	2	10	1035.00
3022024	500	5	5	5	1345.00
3022029	1000	10	10	4	2040.00
3022030	2000	20	20	4	3915.00

*150 ml Not covered in any standards.

3026 - CYLINDERS

ASTM, Class A, Hexagonal base, Pour out, with Individual Calibration Certificate

- Complies with ASTM E 1272
- Graduated, Single Metric Scale
- Each cylinder is engraved with a unique serial number, and comes with a Certificate of Calibration traceable to national standards
- Graduations in amber enamel
- Sturdy hexagonal base prevents roll-over and ensures greater stability
- Calibrated and certified at 20°C

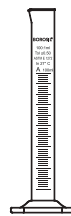

Cylinders

Product Code	Capacity ml	Graduation Interval ml	Tolerance ± ml	Quantity Per Case	Price / Piece ₹
3026005	5	0.1	0.05	5	705.00
3026006	10	0.2	0.10	5	815.00
3026009	25	0.5	0.17	5	920.00
3026012	50	1	0.25	5	1095.00
3026016	100	1	0.50	5	1225.00
3026021	250	2	1	5	1780.00
3026024	500	5	2	4	2350.00
3026029	1000	10	3	4	2900.00
3026030	2000	20	6	4	5420.00

3027 - CYLINDERS

ASTM, Class B, Hexagonal base, Pour out

- Complies with ASTM E 1272
- Graduated, Single Metric Scale
- Each cylinder is engraved with a unique serial number, and comes with a Certificate of Calibration traceable to national standards
- Graduations in amber enamel
- Sturdy hexagonal base prevents roll-over and ensures greater stability
- Calibrated at 20°C



Till stock lasts					
Product Code	Capacity ml	Graduation Interval ml	Tolerance ± ml	Quantity Per Case	Price / Piece ₹
3027005	5	0.1	0.1	5	420.00
3027006	10	0.2	0.2	5	485.00
3027009	25	0.5	0.34	10	565.00
3027012	50	1	0.5	10	635.00
3027016	100	1	1	10	695.00
3027021	250	2	2	10	1215.00
3027024	500	5	4	5	1510.00
3027029	1000	10	6	4	2245.00
3027030	2000	20	12	4	4150.00



3032 - TAPPED DENSITY CYLINDER

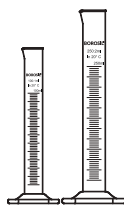

- As Per USP, Ch. 616
- Supplied as a set of two cylinders
- Used in tapped density apparatus to measure bulk density of powders
- Graduation in amber enamel
- Sturdy hexagonal base prevents roll-over and ensures greater stability
- Calibrated at 20°C

Product Code	Capacity ml	Quantity Per Case Set	Price / Set ₹
3032041	100 & 250	1 Each	3310.00

3033 - TAPPED DENSITY CYLINDER



- As Per USP, Ch. 616

Product Code	Capacity ml	Quantity Per Case Set	Price / Piece ₹
3033016	100	2	1725.00

3034 - TAPPED DENSITY CYLINDER



- As Per USP, Ch. 616

Product Code	Capacity ml	Quantity Per Case Set	Price / Piece ₹
3034021	250	2	1990.00

3070 - RAIN MEASURE CYLINDERS

Round base



- Complies with IS 4849
- Graduated, Single metric scale
- Graduation in white enamel
- The cylinders are graduated to indicate rainfall in mm when used with appropriate rain collector
- Calibrated at 27°C

Product Code	Size mm	Used For Collector Area cm ²	Graduation Interval mm	Tolerance ± ml	Quantity Per Case	Price / Piece ₹
3070096	20	200	0.2	0.05	5	1515.00
3070098	20	100	0.2	0.10	10	1775.00



3041 - CROW CYLINDER with Interchangeable Joint Class A, with Individual Calibration Certificate

- Graduated Single metric scale
- Each cylinder is engraved with a unique serial number and is provided with a calibration certificate traceable to national standards
- Calibrated and certified at 20°C
- Ideal for the collection and measurement of distillate in oil and jar tests

Product Code	Capacity ml	Tolerance ± ml	Quantity Per Case	Price / Piece ₹
3041016	100	0.4	5	1800.00



2010 - CYLINDERS

NABL Certified, Class A, Hexagonal base, Pour out, with Individual Calibration Certificate

- Complies with IS 1997, ISO 4788 **with ISI Mark**
- Graduated, Single Metric Scale
- Calibrated & certified at 27°C and supplied with NABL certificate of calibration traceable to National standards
- Graduations in amber enamel
- Sturdy hexagonal base prevents roll-over and ensures greater stability

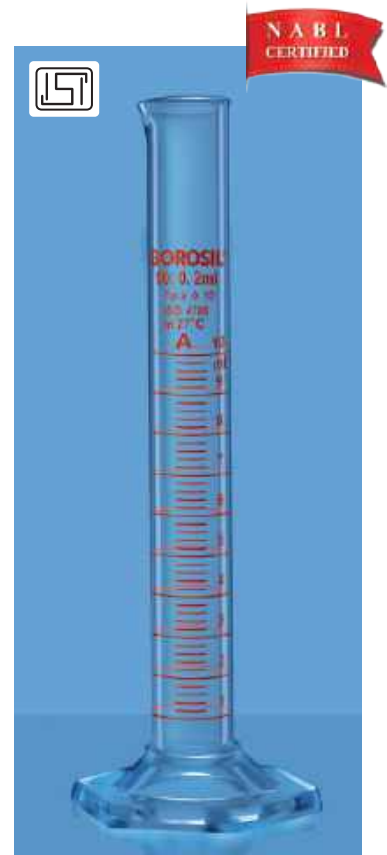
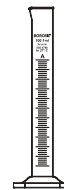

Product Code	Capacity ml	Graduation Interval ml	Tolerance ± ml	Quantity Per Case	Price / Piece ₹
2010005	5	0.1	0.05	1	1650.00
2010006	10	0.2	0.10	1	1615.00
2010009	25	0.5	0.25	1	1880.00
2010012	50	1	0.50	1	2225.00
2010016	100	1	0.50	1	2520.00
2010018	150*	2	1	1	3375.00
2010021	250	2	1	1	3810.00
2010024	500	5	2.5	1	5185.00
2010029	1000	10	5	1	6415.00
2010030	2 L	20	10	1	8190.00

* 150 ml not covered in standard.

Hydrometers



Hydrometers



BOROSIL® Scientific brand, Hydrometers are manufactured using chemically neutral glass tubes, ensuring durability and precision. The tube diameters are carefully selected based on the required density range to provide accurate measurements. Each hydrometer undergoes multiple tests at various points, guaranteeing an accuracy of ± 1 division. Designed for a wide range of applications, they are calibrated in Baumé, Brix, Twaddle, density, and specific gravity scales. Additionally, some models feature a built-in thermometer for temperature-compensated readings, enhancing their functionality and reliability.



3050 - RANGE FINDER GLASS HYDROMETERS

- General Purpose Hydrometer for selecting appropriate hydrometer.
- Dual Scale – Sp. Gr. And Baume combined Calibrated at 20°C, Length 300 mm, Accuracy : ± 1 division

Product Code	Hydrometer Range	Division	Quantity Per Case	Price / Piece ₹
3050001	1.000 - 2.000 & Baume 0-70 (Heavy liquid)	0.010 & 1°Be	25	225.00
3050002	0.700 - 1.000 & Baume 10-70 (Light liquid)	0.005 & 1°Be	20	270.00
3050003	1.000 - 1.500 & Baume 0-50	0.005 & 1°Be	20	270.00
3050004	1.500 - 2.000 & Baume 50-70	0.005 & 1°Be	20	270.00



3051 - TWADDLE GLASS HYDROMETER

- Twaddle is a simplified Sp. Gr. Hydrometer – each twaddle equals 0.005 Sp. Gr.
- Calibrated at 20°C, Length 300 mm, Accuracy : ± 1 division Used in Chemical, Leather, Textile industries

Product Code	Twaddle Number	Twaddle Range (°Tw)	Division (°Tw)	Quantity Per Case	Price / Piece ₹
3051001 to 003	1, 2	0 to 26, 24 to 50, 48 to 74	1	25	270.00
3051004 to 006	4, 5	72 to 104, 120 to 138, 136 to 174	1	25	330.00

3052 - SPECIFIC GRAVITY GLASS HYDROMETERS, 100 DIVISIONS RANGE

- Narrow Range Specific Gravity Hydrometer with 100 divisions
- Calibrated at 20°C, Length 300 mm, Accuracy : ±1 division

Product Code	Specific Gravity Hydrometer Range	Division	Quantity Per Case	Price / Piece ₹
3052001	0.600 - 0.700	0.001	20	450.00
3052002 to 004	0.700 - 0.800, 0.800 - 0.900, 0.900 - 1.000	0.001	20	270.00
3052005 to 007	1.000 - 1.100, 1.100 - 1.200, 1.200 - 1.300	0.001	20	270.00
3052008 & 009	1.300 - 1.400, 1.400 - 1.500	0.001	20	270.00
3052010 to 012	1.500 - 1.600, 1.600 - 1.700, 1.700 - 1.800	0.001	20	390.00
3052013 & 014	1.800 - 1.900, 1.900 - 2.000	0.001	20	495.00

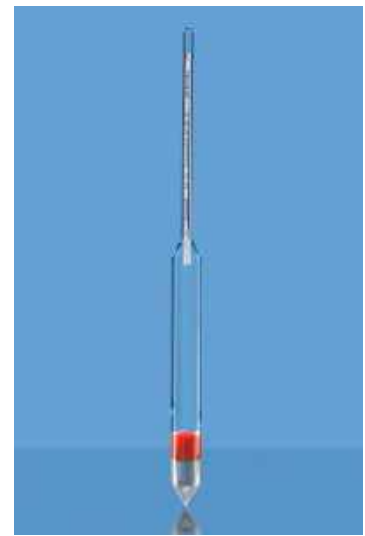

Hydrometers

3053 - BAUME GLASS HYDROMETERS

- Used to measure specific gravity on evenly spaced scale.
- Calibrated at 20°C, Length 300 mm, Accuracy : ±1 division

Product Code	Baumé Hydrometer Range	Division	Quantity Per Case	Price / Piece ₹
3053001	00-30	0.5 °Bé	25	270.00
3053002 to 004	30-60, 00-40, 00-50	0.5 °Bé	20	270.00
3053005 to 007	00-20, 20-40, 40-60	0.2 °Bé	20	270.00
3053008 to 012	00-10, 10-20, 20-30, 30-40, 40-50	0.1 °Bé	20	270.00
3053013 & 3053014	50-60, 60-70	0.1 °Bé	20	390.00
3053015	00-70	1 Bé	25	270.00
3053016	00-100	1 Bé	20	390.00

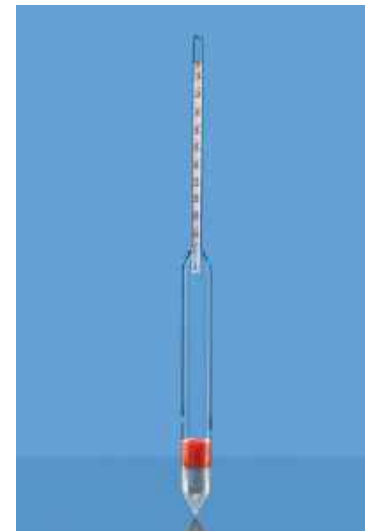

3054 - ALCOHOLMETERS (GAY LUSSAC HYDROMETERS)

- Used to measure the alcohol % by volume in a liquid or distillate, Calibrated at 20°C, Accuracy : ±2 divisions

Product Code	Alcohol % Range	Division	Quantity Per Case	Price / Piece ₹
3054001	00-100	1%	25	270.00
3054002 to 007	0-10%, 10-20%, 20-30%, 30-40%, 40-50%, 50-60%	0.10%	5	1020.00
3054008 to 012	60-70%, 70-80%, 80-90%, 90-100%, 94-104%	0.10%	5	1020.00





3055 - TRIPLE SCALE HYDROMETERS

- Triple scale - Specific Gravity, °Bx and Alcohol %, Calibrated at 60°F, Length 300 mm, Accuracy : ±2 divisions
- Used in home brewing and wine making., Used for brewing wine, beer, kombucha and alcohol.

Product Code	Range	Division	Quantity Per Case	Price / Piece ₹
3055001	"Specific Gravity : 0.990 – 1.170 Brix : 0 – 39 °Bx Alcohol % by volume : 0 – 22 %"	"0.001 0.5 °B 1%"	20	810.00

3056 - BATTERY HYDROMETERS

- Hydrometer to check the specific gravity of battery electrolyte, Calibrated at 27°C, Accuracy : ±1 division
- Battery tester set with glass hydrometer with coloured markings for easy visibility, in heavy borosilicate glass tube with rubber suction ball and connecting rubber piece to withdraw sample from the battery.
- Used in battery manufacturing industries, automobile industries, railways, military stations, telecom departments and power stations to check the specific gravity of battery electrolyte.

Product Code	Model	Specific Gravity Range	Division case	Quantity Per Case	Price / Piece ₹
3056001	AxB Heavy Duty	1.100 - 1.300	0.01	25	330.00
3056002	A2B Heavy Duty	1.100 - 1.300	0.002	25	570.00

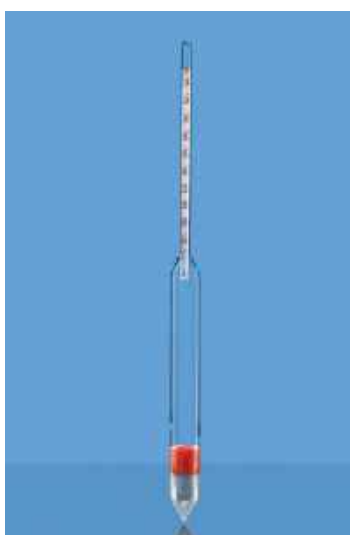

3057 - BRIX HYDROMETERS WITH BUILT IN THERMOMETERS (BRIX THERMOHYDROMETERS)

- Brix hydrometer but with built in thermometer range 0-50°C.
- Used in the wine, sugar, carbonated beverage, fruit juice, fresh produce, maple syrup, and honey industries.

Product Code	Brix Hydrometer Range (°Bx) & Thermometer Range	Division	Quantity Per Case	Price / Piece ₹
3057001	00-10 & 0-50 °C, 10-20 & 0-50 °C, 10-20 & 0-50 °C,	0.1 °Bx & 1°C	2	1080.00

3058 - DENSITY HYDROMETERS, M-50 SP SERIES

- These hydrometers are graduated to indicate density in g/ml, Used in petroleum and oil industries.
- Manufactured as per IS-3104 - Part 1, Calibrated at 15°C, Length 270 mm, Accuracy : ±1 division

Product Code	Density Hydrometer Range (g/ml)	Division (g/ml)	Quantity Per Case	Price / Piece ₹
3058001	0.600-0.650	0.001	10	840.00
3058002 to 005	0.650-0.700, 0.700-0.750, 0.750-0.800, 0.800-0.850,	0.001	10	288.00
3058006 to 009	0.850-0.900, 0.900-0.950, 0.950-1.000, 1.000-1.050	0.001	10	288.00
3058010	1.050-1.100	0.001	10	288.00



Hydrometers

3059 - PERCENTAGE HYDROMETERS

- These hydrometers are calibrated based on specific gravity principle in direct percentages
- Can serve as a handy approximation tool in absence of the chemist / for a faster approximation strength in percentage.
- Calibrated at 27°C, Length 300 mm, Accuracy : ±2 divisions

Product Code	Percentage Hydrometer Range	Division	Quantity Per Case	Price / Piece ₹
3059001	Caustic percentage meter: Range 30-50%	0.20%	5	675.00
3059002 & 003	Sulphuric Acid % meter: Range 60-80%, 80-98%	0.20%	5	675.00
3059004	Hydrochloric Acid % meter: Range 25-35%	0.20%	5	675.00
3059005	Nitric Acid % meter: Range 50-75%	0.20%	5	675.00
3059006	Hydrogen Peroxide % meter: Range 30-50%	0.20%	5	675.00



3060 - HYDROMETERS FOR VERY HIGH LIQUIDS

- Special Purpose Hydrometers designed for use very heavy liquids bromine, diiodomethane, bromoform etc.
- Calibrated at 20°C, Length 300 mm, Accuracy : ±2 divisions

Product Code	Specific Gravity Range	Division (g/ml)	Quantity Per Case	Price / Piece ₹
3060001 to 004	2.000-2.500, 2.500-3.000, 3.000, 3.500,	0.005	5	10500.00
3060005 to 007	2.000-3.000, 1.500-2.500, 3.000-3.200	0.01	5	10500.00

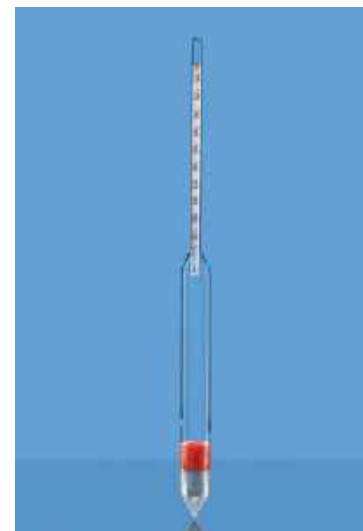

Desiccator

BOROSIL® Scientific brand Desiccators are equipped with bodies and covers that have great strength and utility. The body is designed with a streamlined contour that facilitates easy cleaning of the used desiccant. Any desiccant such as sulphuric acid, phosphoric pentoxide, calcium chloride or silica gel may be used in Borosil Scientific brand Desiccators. For your convenience, all Borosil Scientific brand Plain Desiccators of the same size have interchangeable covers and bodies. When the ground surface is cleaned and greased, Vacuum type Desiccators hold a vacuum of 500 mm of mercury.



3082 - DESICCATOR SET

With Cover & Porcelain Plate

- Complies with IS 6128
- Supplied with cover and porcelain plate, plastic knob
- Simple design for drying under atmospheric pressure
- Ground glass flanges
- Plates are positioned on an internal ledge within the base
- Generally used for drying of moist products, and for storage of moisture-sensitive substances

Product Code	Nominal Diameter mm	Approx Volume ml	Approx Flange OD mm	Approx Total Height mm	Quantity Per Case	Price / Piece ₹
3082041	100	120	153	173	1	10160.00
3082042	150	410	213	205	1	11860.00
3082043	200	975	272	272	1	16525.00
3082044	250	1825	333	323	1	21115.00
3082045	300	2555	395	344	1	29700.00

Spare porcelain plate available on request



3083 - VACUUM DESICCATOR SET

With Cover & Porcelain Plate

- Complies with IS 6128
- Supplied with cover having stopcock with PTFE spindle, porcelain plate and plastic knob
- Simple design for drying under atmospheric pressure
- Ground glass flanges
- Plates are positioned on an internal ledge within the base
- Designed for use under vacuum
- Generally used for drying of moist products, and for storage of moisture-sensitive substances

Product Code	Nominal Diameter mm	Approx Volume ml	Approx Flange OD mm	Total Height mm	Quantity Per Case	Price / Piece ₹
3083041	100	120	153	173	1	15560.00
3083042	150	410	213	205	1	23410.00
3083043	200	975	272	272	1	26275.00
3083044	250	1825	333	323	1	36475.00
3083045	300	2555	395	344	1	45825.00

Spare porcelain plate and stopcock available on request

3084 - DESICCATOR SET

With Cover & Porcelain Plate **Amber**

- Complies with IS 6128
- Supplied with cover and porcelain plate, plastic knob
- Simple design for drying under atmospheric pressure
- Ground glass flanges
- Plates are positioned on an internal ledge within the base
- Amber coating to protect light sensitive chemicals
- Generally used for drying of moist products, and for storage of moisture-sensitive substances



Desiccator

Product Code	Nominal Diameter mm	Approx Volume ml	Approx Flange OD mm	Total Height mm	Quantity Per Case	Price / Piece ₹
3084041	100	120	153	173	1	13430.00
3084042	150	410	213	205	1	15390.00
3084043	200	975	272	272	1	19835.00
3084044	250	1825	333	323	1	25200.00
3084045	300	2555	395	344	1	39435.00

Spare cover and porcelain plate available on request

3085 - VACUUM DESICCATOR SET

With Cover & Porcelain Plate, **Amber**

- Complies with IS 6128
- Supplied with cover having stopcock with PTFE spindle, porcelain plate and plastic knob
- Simple design for drying under atmospheric pressure
- Ground glass flanges
- Plates are positioned on an internal ledge within the base
- Designed for use under vacuum
- Amber coating to protect light sensitive chemicals
- Generally used for drying of moist products, and for storage of moisture-sensitive substances



Product Code	Nominal Diameter mm	Approx Volume ml	Approx Flange OD mm	Total Height mm	Quantity Per Case	Price / Piece ₹
3085041	100	120	153	173	1	24400.00
3085042	150	410	213	205	1	31345.00
3085043	200	975	272	272	1	34255.00
3085044	250	1825	333	323	1	49365.00
3085045	300	2555	395	344	1	55375.00

Spare porcelain plate and stopcock available on request

Steps for Assembling Vacuum Desiccator	STEP 1	STEP 2	STEP 3	STEP 4	STEP 5
	 <ul style="list-style-type: none"> Remove the different parts supplied with the Desiccator <ul style="list-style-type: none"> Bottom Lid Porcelain plate Stop cock 	Place the porcelain plate in the bottom part of the desiccator	Place the lid over it	Remove the blue knob from the lid and fit the stopcock in blue knob	Screw the blue knob along with the stopcock on the lid. Connect the desiccator to a vacuum source (pressure 1 bar) with a rubber tube.

Dishes

BOROSIL Scientific brand Dishes are designed to fulfil your wide-ranging needs - Crystallizing, Evaporating, Drying, Storing, Petri Dishes for culture, assay and micro-biological works. All **BOROSIL Scientific** brand Dishes are safe, durable and economical.

BOROSIL Scientific brand Dishes are inert, can be sterilised and remain clear even after repeated use and washing. With each subsequent use, the cost per Dish decreases.

Made from 3.3 Low Expansion
Borosilicate Glass



Please contact CT Enterprises for quotation.

Email: sales@ctenterprises.in | Phone: +91 8977721310

3140 - CRYSTALLIZING DISHES

- Reinforced and fire-polished rims reduce chipping
- Large labelling field for easy marking
- Very high resistance to chemicals and thermal shocks
- Ideal for crystallization and in hot/ice baths

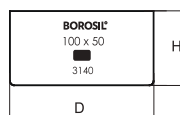

Product Code	Approx O.D. x Height mm	Approx Capacity ml	Quantity Per Case	Price / Piece ₹
3140077	100 x 50	330	10	630.00
3140081	150 x 75	1150	10	1100.00
3140086	190 x 100	2500	4	1830.00



3160 - PETRI DISHES (3.3 Borosilicate)

- Made of 3.3 low expansion borosilicate glass
- Complies with IS 2626
- These dishes are clear and withstand repeated sterilisation cycles (wet or dry)
- Beaded edges impart greater mechanical strength
- Specially formed to ensure even wall thickness and consistent optical performance
- Ideal culture vessel for microbiology and plant tissue culture applications

Product Code	Size mm	LID Approx I.D. (D1) x Height (H1) mm	Bottom Approx O.D. (D2) x Height (H2) mm	Quantity Per Case	Price / Piece ₹
3160065	50 x 17	53 x 15	50 x 17	100	250.00
3160072	80 x 17	83 x 15	80 x 17	100	320.00
3160077	100 x 17#	103 x 15	100 x 17#	100	375.00
3160081	150 x 20	153 x 17	150 x 20	40	920.00
3160087	200 x 20	203 x 20	200 x 20	10	1980.00

Not covered in standard

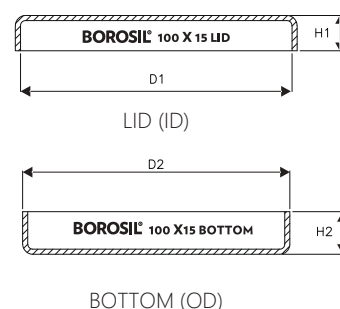

3165 - S LINE PETRI DISHES

- Made of sodalime glass
- S-Line petri dishes with durable white enamel printing - with lid and bottom mentioned on it
- Helps in quick identification of the lid and the bottom while sorting and pairing the petri dishes during use
- Optically clear and bubble free for making critical observations
- Flat inner surface for uniform distribution of media
- Ideal culture vessel for microbiology and plant tissue culture applications

Product Code	Size mm	LID Approx I.D. (D1) x Height (H1) mm	Bottom Approx O.D. (D2) x Height (H2) mm	Quantity Per Case	Price / Piece ₹
3165065	50 x 12	46 x 8	44 x 12	100	115.00
3165072	80 x 15	76 x 12	74 x 15	100	130.00
3165A75	90 x 15	86 x 12	84 x 15	100	130.00
3165077	100 x 15	96 x 12	94 x 15	100	130.00
3165A77	100 x 20	96 x 15	94 x 20	100	205.00
3165081	150 x 25	143 x 18	141 x 25	40	315.00
3165087	200 x 30	195 x 24	192 x 30	10	660.00

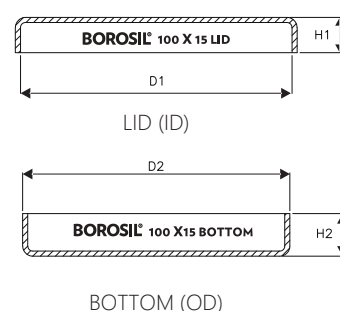

• Dishes
• Distilling Apparatus
• Water Distilling Unit
• Survismeter & Viscometer

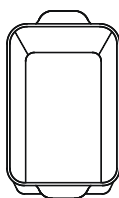

3170 - DRYING TRAYS

- Made with a heavy wall, withstand hot air or steam sterilization
- Facilitates paper chromatography
- Dimensions are approximate, representing the inside

Product Code	Approx Dimension mm	Approx Capacity ml	Quantity Per Case	Price / Piece ₹
3170044	320 x 180 x 51	1500	5	795.00
3170043	350 x 200 x 58	2400	5	1115.00
3170042	386 x 217 x 63	3000	5	1540.00
3170041	404 x 257 x 61	3500	5	1850.00

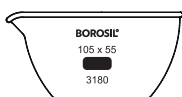

3180 - FLAT BOTTOM EVAPORATING DISHES With Spout

- Withstands repeated sterilisation (Wet or dry)
- Designed with a spout to facilitate clean pouring
- Very high resistance to chemicals and thermal shocks
- Beaded edge give greater mechanical strength
- Ideal for evaporating solvents in hot/ice baths

Product Code	Approx Dimension mm	Approx Capacity ml	Quantity Per Case	Price / Piece ₹
3180072	80 x 45	165	10	545.00
3180078	105 x 55	290	10	770.00
3180081	150 x 80	855	10	1425.00
3180087	200 x 100	1790	8	2630.00

S LINE

Petri Dishes

Culture vessel for

- Microbial applications
- Plant tissue culture applications

Made from 3.3 Low Expansion
Borosilicate Glass



NOW Lid and Bottom identification is EASY !!!



Please contact CT Enterprises for quotation.

Email: sales@ctenterprises.in | Phone: +91 8977721310

Distilling Apparatus

Most of the distillation equipment required in an average laboratory can be constructed using standard Borosil components. Distillation assemblies for specific applications are available as complete units, as listed herein.

Made from 3.3 Low Expansion Borosilicate Glass



Please contact CT Enterprises for quotation.

Email: sales@ctenterprises.in | Phone: +91 8977721310

3340-DISTILLING APPARATUS

With Graham Condenser And Interchangeable Joints

- Ideal for determining nitrogen in organic compounds
- Digestion and distillation stages can be performed in this apparatus
- The inlet tube allows permanganate solution to be introduced after distillation
- Large labelling field for easy marking

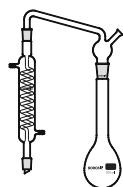

Product Code	Capacity ml	Quantity Per Case	Price / Piece ₹
3340024	500	2 Set	4545.00

Spare parts available on request

Distilling Apparatus

3360-DISTILLING APPARATUS

With Graham Condenser, Interchangeable Joints and Stopper

- Ideal for batch production of high purity distilled water
- General purpose Batch Distillation Assembly equipped
- with an interchangeable stoppered neck that facilitates addition
- The Flask has a flat base with a delivery tube on the side

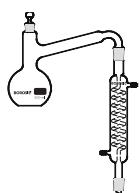

Product Code	Capacity ml	Condenser Jacket mm	Inter-changeable Joint	Quantity Per Case	Price / Piece ₹
3360024	500	200	19 /26	2 Set	4550.00

Spare parts available on request

3380- DISTILLING APPARATUS

with Friedrichs Condenser, Interchangeable Joint and Stopper

- Ideal for batch production of high purity distilled water
- With Friedrich's Spiral Condenser for higher distillation rates
- General purpose Batch Distillation Assembly equipped with an interchangeable stoppered neck that facilitates addition
- The Flask has a flat base with a delivery tube on the side

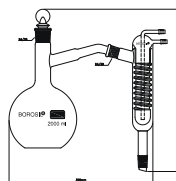

Product Code	Capacity ml	Interchange-able Joint	Quantity Per Case	Price / Piece ₹
3380030	2000	24 / 29	1 Set	6230.00

Spare parts available on request

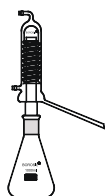

3440-DISTILLING APPARATUS with Friedrichs Condenser, Interchangeable Joint

- Compact
- A compact distillation assembly with specially designed Friedrich's Condensers
- This Condenser is designed with vapour tubing rising at
- A 1000 ml Erlenmeyer Flask is provided with an interchangeable 34/35 joint

Product Code	Capacity ml	Interchangeable Joint	Quantity Per Case	Price / Piece ₹
3440029	1000	34 / 35	2 Set	5820.00
Spare parts available on request				



3450-ESSENTIAL OIL DETERMINATION APPARATUS

(Clevenger Apparatus), As per IS 1797

- Ideal for estimation of **volatile oil that is heavier than water**
- Supplied with a 5 ml Receiver with stopcock, an Oil Separator Tube, a condenser and 1000 ml flask

Product Code	Capacity ml	Quantity Per Case	Price / Piece ₹
3450029	1000	1 Set	10485.00
3450030	2000	1 Set	On request
3450033	5000	1 Set	On request
3450038	10000	1 Set	On request
3450040	20000	1 Set	On request
Spare parts available on request			



3451-ESSENTIAL OIL DETERMINATION APPARATUS

(Clevenger Apparatus)

- Ideal for estimation of **volatile oil that is lighter than water**
- Supplied with a 5 ml Receiver with stopcock, an Oil Separator Tube, a condenser and 1000 ml flask

Product Code	Capacity ml	Quantity Per Case	Price / Piece ₹
3451029	1000	1 Set	10485.00
3451030	2000	1 Set	On request
3451033	5000	1 Set	On request
3451038	10000	1 Set	On request
3451040	20000	1 Set	On request
Spare parts available on request			

3452 - ALCOHOL DISTILLATION UNIT

- Ideal for distilling alcohol in the laboratory to produce the purest grade
- Thorpe's revenue still for purification of ethyl alcohol popularly used in pharmaceutical industries



Product Code	Capacity ml	Quantity Per Case	Price / Piece ₹
3452029	1000	1 Set	13030.00

Spare parts available on request



Distilling Apparatus

3454 - R M VALUE APPARATUS

- Ideal for use in dairy industries
- Facilitates the determination of butter fat, and the analysis of oil, fat and waxes

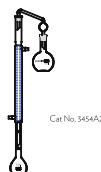

Product Code	Capacity ml	Quantity Per Case	Price / Piece ₹
3454022	300	1 Set	3435.00
3454A22*	300	1 Set	4860.00

* As per IS 548 Part I Standard

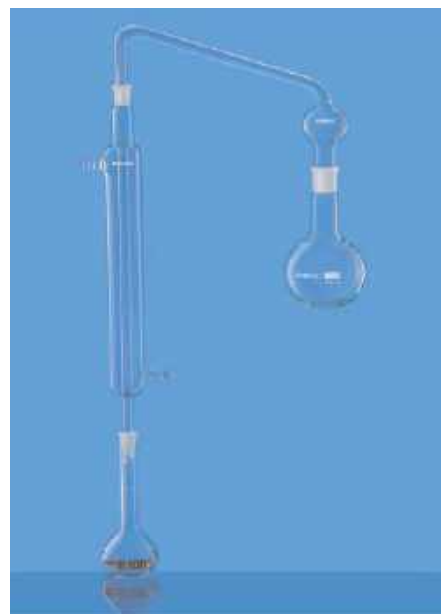

Product Code	Product description	Quantity Per Case	Price / Piece ₹
3454S01	STILL HEAD WITH RUBBER CORK (Used with 3454A22)	1	1255.00
3454S02	Splash head with ground stopper	1	1925.00
3454S03	Condenser liebigh drip trip 14/23	1	1065.00
3454S04	Flat bottom flask 24/29, 300ml	1	395.00
3454S05	Vol flask 100ml, 14/23 neck Class B	1	405.00

3455 - ETHANOL DISTILLATION GLASS ASSEMBLY

NEW PRODUCT

Product Code	Capacity ml	Quantity Per Case	Price / Piece ₹
3455001	1000	1 Set	9900.00

Spare parts available on request

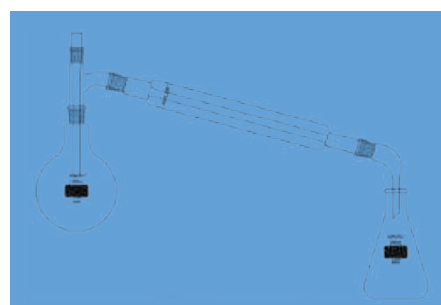

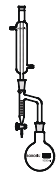

3602- DEAN STARK DISTILLING APPARATUS

As per IP

- Made of 3.3 borosilicate glass
- Uniform wall distribution of the Flask makes it suitable for heating
- Consists of a graduated 10 ml Receiver with 0.1 ml intervals

Product Code	Capacity of Receiver Tube ml	Quantity Per Case	Price / Piece ₹
3602005	5	2 Set	3675.00
3602006	10	2 Set	3930.00

Spare parts available on request

Receiver Tube 5ml / 10 ml graduated with 19 / 26 outer joint and 24 / 29 inner joint,
 Note: 10 ml receiver tube is graduated from 1 ml to 10 ml in 0.1 ml intervals

Round bottom flask 1000 ml with 24 / 29 outer joint

Liebig condenser 200 mm with 19 / 26 joint

Delivering classical solution
with modernized approach.

The only Soxhlet apparatus

with ACTUAL TIME SETTING AND
ENERGY PERCENTAGE DISPLAY

Distilling
Apparatus



● Extractor knob for solvent recovery

● Built in calibration for error setting.

● Safe temperature setting to prevent accidents.

● Rotary knob for precise setting of time, safe temperature and energy percentage regulation

**ON
DEMAND**

Water Distillation Units

Distillation is the most reliable and cost effective method of generating pure water for laboratory uses like reagents, buffer preparations, pH solutions, rinsing, media preparation, in baths, autoclaves etc.

Distillation generates water free of organic, inorganic impurities from feed water without the need to spend large sums on membranes, resins or filters.

Borosil's ON DEMAND Automatic distillation units empowers the user to set the demand for a set volume of pure water. The unit operates automatically to deliver the set volume and turns itself off.

A system prompted step by step guide assists the user in cleaning the unit for an uninterrupted operation.

Safety features for auto cut-off incase of water supply failure or boiler overheating.



Please contact CT Enterprises for quotation.

Email: sales@ctenterprises.in | Phone: +91 8977721310

Water Distillation Unit

General laboratory applications requiring higher ionic purity, samples & buffer preparations

On Demand Single Distillation Unit (SDU)

Single Stage Distillation units provide automatic working for getting pure water by distillation method capable of removing a wide spectrum of impurities. Raw water is boiled to produce steam which is taken to a condenser where it returns to the liquid state, free of impurity. The impurities remain in the boiler and can be removed periodically with the help of in built descaling or cleaning guide.



Water Distillation Unit

Technical Data & Ordering Information

Model Name	SDU1500	SDU2500	SDU4000
Capacity Distilled Water Output	1.5 LPH	2.5 LPH	4 LPH
Minimum cooling water requirement (Ltr/min)	1	1.5	2
Heater	Quartz	Quartz	Quartz
Boiler	Boro 3.3	Boro 3.3	Boro 3.3
Condenser	Boro 3.3	Boro 3.3	Boro 3.3
Biological Activity	Pyrogen Free	Pyrogen Free	Pyrogen Free
Conductivity S/cm*	<3 × 10 ⁻⁶	<3 × 10 ⁻⁶	<3 × 10 ⁻⁶
Power consumption (kw)	1.7kW	2.5kW	3kW
Voltage (V)	230V	230V	230V
Dimensions (L × B × H) in mm	650 × 320 × 440		
HSN Code	84198990		
Ordering Code	BLFRSDU150000000000	BLFRSDU250000000000	BLFRSDU400000000000
Prices / Piece	49,240.00	68,700.00	76,330.00

* Inlet water TDS < 100 ppm

* The specified distillate quality is achieved by using treated water as boiler feed and collecting the distillate in a sealed quartz container to prevent CO₂ exposure.

Spares & Accessories refer page - 295

Note: Because of difficulties associated with measurement of the pH value of high purity water and the doubtful significance values obtained, limits for the pH value of grade 1 & grade 2 water have not been specified. Conductivity specified applies for freshly prepared water in absence of Carbon Dioxide at 20° C.

3369- SILICONE TUBING FOR DISTILLATION UNIT & LABORATORY APPLICATION

*Heat Resistance Temperature Range: -40°C To +205°C

The technical data given by Borosil must be used as a guide only Borosil does not guarantee the accuracy of information and is not responsible for its end use.

Silicone tubing is used for laboratory and industrial applications only. It should not be used for implants, human reproductive system and other medical applications.

336900 - 8mm x 12mm is used for 3361-1.5, 3362-1.5, 3363-2.5series

3369004 - 10mm x 14mm is used for 3361-4l, 3362-4l,3364-2.5l, 5l, 3365-1.5l,2.5l,5l, 3363-5l,10l.



Product Code	Size mm	Quantity per case	HSN Code	Price for 10 Meter ₹ in mtr
3369001	4 mm ID × 7 mm OD	10	40091100	2150.00
3369002	6 mm ID × 9 mm OD	10	40091100	2860.00
3369003	8 mm ID × 12 mm OD	10	40091100	5830.00
3369004	10 mm ID × 14 mm OD	10	40091100	7130.00

Water Distillation Unit

General laboratory applications requiring higher ionic purity, samples & buffer preparations

On Demand Double Distillation Unit (DDU)

Double Stage Distillation Units provide automatic working for getting pure water by distillation method capable of removing a wide spectrum of impurities. Raw water is boiled to produce steam which is taken to a condenser where it returns to the liquid state, free of impurity. The impurities remain in the boiler and can be removed periodically with the help of in built descaling or cleaning guide.



Water
Distillation Unit

Technical Data & Ordering Information

Model Name	DDU1500	DDU2500	DDU4000
Capacity Distilled Water Output	1.5 LPH	2.5 LPH	4 LPH
Minimum cooling water requirement (Ltr/min)	1	1.5	2
Heater	Quartz	Quartz	Quartz
Boiler	Boro 3.3	Boro 3.3	Boro 3.3
Condenser	Boro 3.3	Boro 3.3	Boro 3.3
Biological Activity	Pyrogen Free	Pyrogen Free	Pyrogen Free
Conductivity S/cm*	<3 × 10 ⁻⁶	<3 × 10 ⁻⁶	<3 × 10 ⁻⁶
Power consumption (kw)	3kW	4.4kW	6kW
Voltage (V)	230V	230V	230V
Dimensions (L × B × H) in mm	650 × 550 × 520		
HSN Code	84198990		
Ordering Code	BLFRDDU15000000000	BLFRDDU25000000000	BLFRDDU40000000000
Prices / Piece	77,830.00	1,26,210.00	1,37,280.00

* Inlet water TDS < 100 ppm

* The specified distillate quality is achieved by using treated water as boiler feed and collecting the distillate in a sealed quartz container to prevent CO₂ exposure.

Spares & Accessories refer page - 295

Note: Because of difficulties associated with measurement of the pH value of high purity water and the doubtful significance values obtained, limits for the pH value of grade 1 & grade 2 water have not been specified. Conductivity specified applies for freshly prepared water in absence of Carbon Dioxide at 20° C.

Quartz Cabinet Distillation

On Demand Quartz Double Distillation Unit (QCD)

Double Stage Quartz cabinet units with reservoir provide automatic working with safety cut-offs for dry-run/unstable water flow. It also offers dispensing serially or continuously from reservoir storage.



Water
Distillation Unit

Technical Data & Ordering Information

Model Name	QCD 250
Orientation	Vertical
Design	Bench Top Cabinet
Capacity Distilled water Output	2.5LPH
Minimum cooling water requirement (Ltr/min)	2
Dimensions (L*B*H) along with reservoir	730 × 500 × 1020
Heater	Quartz
Boiler	Quartz
Condensor	Quartz
Biological Activity	Pyrogen Free
Conductivity S/cm*	<1 × 10 ⁻⁶
Power consumption (kw)	4kW
Voltage (V)	230 V
Dry Run Protection	Yes
On Demand Output	Yes
Storage Mode	Yes
Auto Filling Reservoir	Yes
Dispense Range (minimum ml)	10ml
Order Code	BLFRQCD25000000000
HSN Code	84194090
Prices / Piece	3,09,500.00

*1 Inlet water TDS < 100 ppm

* The specified distillate quality is achieved by using treated water as boiler feed and collecting the distillate in a sealed quartz container to prevent CO₂ exposure.

Note: Because of difficulties associated with measurement of the pH value of high purity water and the doubtful significance values obtained, limits for the pH value of grade 1 & grade 2 water have not been specified. Conductivity specified applies for freshly prepared water in absence of Carbon Dioxide at 20°C. Conductivity values are affected by temperature and absorbed carbon dioxide quantity along with other contaminants from containers stored.

Water Distillation Unit

Manufactured from quartz, providing quick & continuous purified water with smaller foot print in laboratories.

Mono Quartz Distillation Units (Manual)

These Innovative and compact vertical Distillation Units Made from Pure Silica - Quartz are ideal choice for getting single stage distilled water. It meets the standard of the analytical laboratory where purity of distilled water free from metallic ions and bacteria is important.



Technical Data & Ordering Information

Model Name	3363042	3363033	3363038	3364042	3364033
Capacity Distilled Water Output	2.5 LPH	5 LPH	10LPH	2.5LPH	5LPH
Minimum cooling water requirement (Ltr/min)	1	2	2.5	1	2
Heater	Quartz	Quartz	Quartz	Quartz	Quartz
Boiler	Quartz	Quartz	Quartz	Quartz	Quartz
Condenser	Boro 3.3	Boro 3.3	Boro 3.3	Quartz	Quartz
Biological Activity	Pyrogen Free	Pyrogen Free	Pyrogen Free	Pyrogen Free	Pyrogen Free
Conductivity S/cm*	<3 × 10 ⁻⁶	<3 × 10 ⁻⁶	<3 × 10 ⁻⁶	<3 × 10 ⁻⁶	<3 × 10 ⁻⁶
Power consumption (kw)	2.2 kW	4.4kW	8.8 kW	2.2 kW	4.4 kW
Voltage (V)	230V	230V	230V - 3Phase	230V	230V
HSN Code	841940901				
Ordering Code	BT533363042	BT533363033	BT533363038	BT533364042	BT533364033
Model Prices / Piece	48,700.00	92,240.00	2,10,700	84,070.00	1,61,250.00
Accessory - DAPS Code	3366342	3366333	3366338	3366442	3366433
DAPS Prices / Piece	16,880.00	18,850.00	34,910.00	16,880.00	18,730.00

* Inlet water TDS < 100 ppm

* The specified distillate quality is achieved by using treated water as boiler feed and collecting the distillate in a sealed quartz container to prevent CO₂ exposure.

Spares & Accessories refer page - 295

DAPS - The Unit provides for Automatic working of distillation unit by switching off the heaters in case water level falls below the heating coil, thereby safeguarding the heaters. The unit resumes distillation when water level is restored by pushing reset button on front panel. The water level sensor probe works on 12 V and hence is very safe to handle. The unit also comes with Buzzer. DAPS is unique for each model.

Note: Because of difficulties associated with measurement of the pH value of high purity water and the doubtful significance values obtained, limits for the pH value of grade 1 & grade 2 water have not been specified. Conductivity specified applies for freshly prepared water in absence of Carbon Dioxide at 20°C.

Water Distillation Unit

All quartz innovative & compact design offers consistent purified water in two distillation stages

All Quartz Double Distillation Units

Quartz distillation units are manufactured from fused quartz tubes. The exceptionally high chemical purity and very low solubility of this material enables the production of very high performance system. The greatest possible attention has been taken for technical performance, simplicity of use and efficiency.



Water Distillation Unit

Technical Data & Ordering Information

Model Name	3365041	3365042	3365033
Capacity Distilled Water Output	1.5 LPH	2.5 LPH	5 LPH
Minimum cooling water requirement (Ltr/min)	1	2	2.5
Heater	Quartz	Quartz	Quartz
Boiler	Quartz	Quartz	Quartz
Condenser	Quartz	Quartz	Quartz
Biological Activity	Pyrogen Free	Pyrogen Free	Pyrogen Free
Conductivity S/cm*	<1 × 10 ⁻⁶	<1 × 10 ⁻⁶	<1 × 10 ⁻⁶
Power consumption (kw)	3 kW	4.4kW	8.8 kW
Voltage (V)	230V	230V	230V - 3Phase
HSN Code		84194090	
Ordering Code	BT533365041	BT533365042	BT533365033
Model Prices / Piece	1,39,860.00	2,45,960.00	4,37,740.00
Accessory - DAPS	3366541	3366542	3366533
DAPS Prices / Piece	17,930.00	18,730.00	35,370.00

* Inlet water TDS < 100 ppm

* The specified distillate quality is achieved by using treated water as boiler feed and collecting the distillate in a sealed quartz container to prevent CO₂ exposure.

Spares & Accessories refer page - 295

DAPS - The Unit provides for Automatic working of distillation unit by switching off the heaters in case water level falls below the heating coil, thereby safeguarding the heaters. The unit resumes distillation when water level is restored by pushing reset button on front panel. The water level sensor probe works on 12 V and hence is very safe to handle. The unit also comes with Buzzer. DAPS is unique for each model.

Note: Because of difficulties associated with measurement of the pH value of high purity water and the doubtful significance values obtained, limits for the pH value of grade 1 & grade 2 water have not been specified. Conductivity specified applies for freshly prepared water in absence of Carbon Dioxide at 20°C.

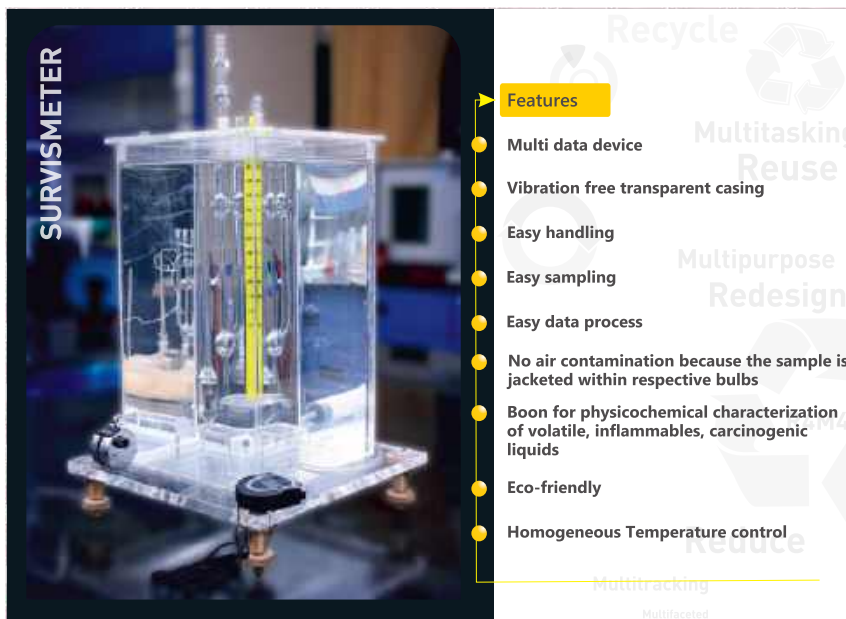

Features

- Multi data device
- Vibration free transparent casing
- Easy handling
- Easy sampling
- Easy data process
- No air contamination because the sample is jacketed within respective bulbs
- Boon for physicochemical characterization of volatile, inflammables, carcinogenic liquids
- Eco-friendly
- Homogeneous Temperature control

Cat. No.	Description	Quantity Per Case	Price ₹
3453	Borosil Mansingh Survismeter For Measurement of surface Tension and Viscosity	1 Set	128995.00

For centuries, surface tension (γ) and viscosity (η) data have been measured using separate instruments, resulting in wastage of time and materials. Made of Borosil Glass material, Borosil Mansingh Survismeter has been designed to measure surface tension, interfacial tension, wetting coefficient, viscosity and friccohesity data to rationalise frictional and cohesive forces, respectively. Friccohesity focuses on a complete friccochemistry of giants and supramolecular mixtures. Borosil Mansingh Survismeter is a state-of-the-art apparatus for measurement of surface tension (± 0.01 mN/m), interfacial tension

(± 0.01 mN/m), viscosity ($\pm 10^{-4}$ mPa.S), wetting coefficient (± 0.01 mPa.cm²) friccohesity ($\pm 10^{-6}$ s/cm) and related physicochemical parameters generated from intramolecular electrostatical shifts.

Borosil Mansingh Survismeter, being a green science TSAD (Trusted Sustainable Analytical Device), measures the above mentioned PCI (PhysicoChemical Indicators), while simultaneously saving 98% of experimental resources, infrastructure and skilled manpower, for interacting and reacting molecular materials.

A breakthrough in laboratory instruments, Borosil Mansingh Survismeter has wider analytical potential for quality control and formulations in material applied sciences. It has unique essential facilities and cutting edge features based on 'On & Off' or '0 & 1' circuitry functional loops.

Fundamentally, Borosil Mansingh Survismeter measures surface tension, interfacial tension, wetting coefficient, viscosity and friccohesity simultaneously of aqueous, non-aqueous, aprotic dipolar, polar, protic polar and non-polar solvents and mixtures within wider ranges.

- The absolute and relative parameters are measured with 95.5% CV (Confidence Variance).
- It works on the theory of R4M4 [Reduce Reuse Recycle Redesign - Multipurpose Multidimensional Multifaceted Multitracking of materials and methods with highly précised and accurate experimental results, along with 100% inhibition of polluting discharges in experimental determinations.

- The parameters measured with Borosil Mansingh Survismeter are highly significant and reliable for quality analysis of pharmaceuticals, biochemicals, cosmetics, agrochemicals, food and beverages, petroleum and oils, polymer and proteins, sol gels, soaps and detergents, inks, colloids, emulsion technology, pesticides, agrochemicals, insecticides, cutting oils, lubricating, viscous, moderately viscous and highly viscous materials.
- It is especially useful for characterising liquid mixtures of biopolymers, supramolecular chemistry, biotechnological processes and molecular interaction engineering of biomolecular devices, tracking interaction molecular forces, water binding capacities and structural changes during processes.
- It explains the features of Intramolecular Multiple Force Theory (IMMFT) applicable to giant supramolecules, dendrimers and biocomplexes used in several adverse temperature and pressure conditions.
- Borosil Mansingh Survismeter is an asset in case of volatile, moderately and highly volatile liquids and mixtures, volatile organic compounds, flammable liquids and carcinogenic materials as the samples are completely jacketed especially for surface tension, interfacial tension and wetting coefficient determinations.

Merits of Borosil Mansingh Survismeter :

- Fast and multipurpose technology
- Eco-friendly and user-friendly
- Reduces fabrication expenditure
- Reduces the need for glass blowing gases, oxygen gas, LPG and manpower
- Reduces emission of heat into the environment
- Ensures safety during transport and maintenance
- Reduces chemicals and solvents greatly
- Contributes to the promotion of green chemistry
- Innovative for youngsters
- No wastage of the sample
- Requires a smaller sample
- Less time required for analysis
- Requires no basic maintenance
- Non-destructive
- Reduces cleaning reagents
- Reduces the number of operational steps in measurement
- Minimises the infrastructure as compared to individual devices

Industrial Applications

Industries such as cosmetics, soaps and detergents, petroleum and oils, pesticides, beverages, textiles, paints, polymers and textiles, paper pulp, ink and dyes, medicines and drugs, food and mineral water, and coolants and lubricants will directly benefit from the use of Borosil Mansingh Survismeter.

Viscometer

**3500-VISCOMETER COLLEGE PATTERN
Oswal 80 -100 Seconds, Uncertified**

Product Code	Size	Nominal Constant	Viscosity Range (CS)	Quantity Per Case	Price / Piece ₹
3500	O	0.001	0.3 - 3	1	2135.00

- Supplied without Certificate

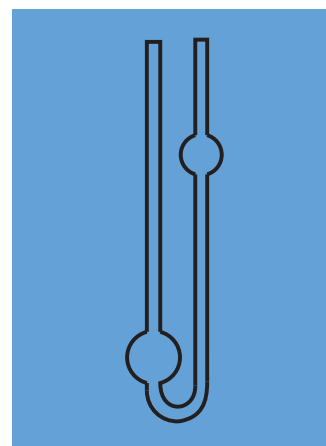

Extractors

Liquid Solid Extraction involves the elution of a solid sample with pure solvent vapour. The sample is held in the Extractor body either directly or in a thimble. The siphoning type of Soxhlet Extractor finds the widest application in laboratory work. Borosil Scientific Soxhlet Extraction Apparatus is available in six sizes. The component parts of the apparatus are provided with interchangeable joints for greater flexibility.



3740 - SOXHLET FOR EXTRACTION APPARATUS

- With interchangeable joints
- Complies with IS 10640
- Designed with a bulb in the siphon tube near the top, to aid the siphoning action
- The vapour tube also protects the siphon tube from accidental damage

Product Code	Capacity ml	Interchangeable Joints		Quantity Per Case	Price / Piece ₹
		Socket	Cone		
3740013	60	34 / 35	24 / 29	5	1120.00
3740016	100	40 / 38	24 / 29	5	1585.00
3740020	200	50 / 42	24 / 29	5	1910.00

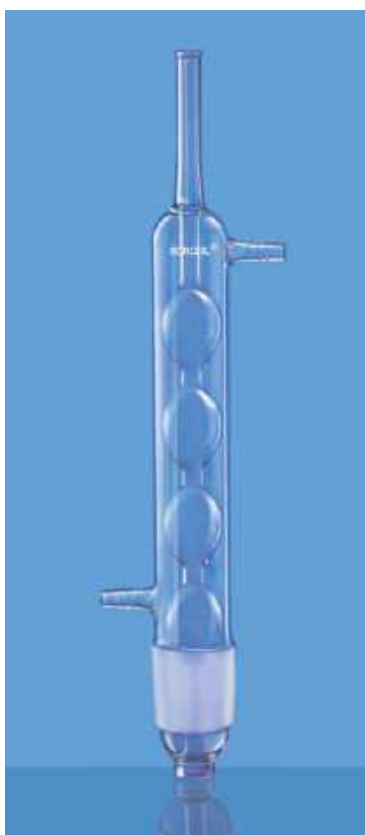

3741 - CONDENSER FOR EXTRACTION APPARATUS

- Greater surface area than the Liebig Condenser owing to a series of bulbs, resulting in higher cooling capacity
- Ideal for laboratory scale refluxing

Product Code	Capacity ml	Interchangeable Joints Cone	Quantity Per Case	Price / Piece ₹
3741013	Small	34 / 35	5	915.00
3741016	Medium	40 / 38	5	1145.00
3741020	Large	50 / 42	5	1655.00

3840 - SOXHLET EXTRACTION APPARATUS SET

- With Interchangeable Joints
- Complies with IS 10640
- Used for separation of the extract from the liquid or solid
- Greater surface area than the Liebig Condenser owing to a series of bulbs, resulting in higher cooling capacity
- This method enables effective separation, with relatively small quantities

Product Code	Capacity ml	Flask Size ml	Quantity Per Case	Price / Piece ₹
3840013	60	150	1	2330.00
3840016	100	250	1	2745.00
3840020	200	500	1	4520.00
3840024	500*	2000	1	16380.00
3840029	1000*	3000	1	24465.00
3840030	2000*	5000	1	41305.00

Spares are available on request

For flask refer Product Code 4100 / 4380 (2000 ml, 3000 ml, 5000 ml)

* Extractor Supplied are with double surface condenser for higher cooling capacity & flange type soxhlet extractors

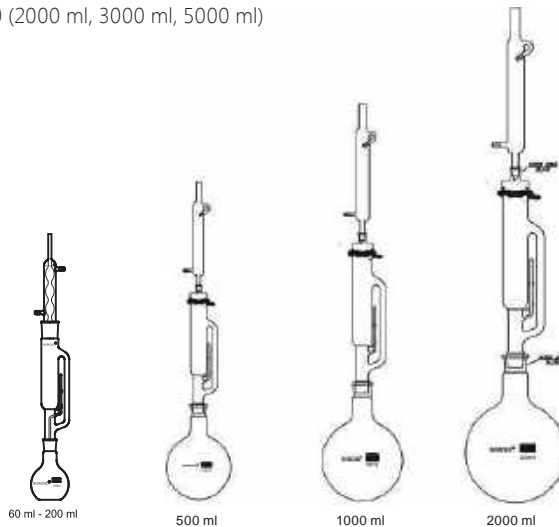

• Extraction Apparatus
• Flasks
• Filtration Products

BOROSIL® Scientific Laboratory Filter Media

Thimbles

Cellulose and Glass Fibre thimbles for accurate and consistent extraction applications.



For more details please refer page no. 249

COD Digestion Unit

Open Reflux COD Digesters-Ideal solutions for waste water analysis



Technical Data & Ordering Information

Model Name	COD082	COD152	COD080	COD150
Reflux Type	Open	Open	Open	Open
Positions	08 Position	15 Position	08 Position	15 Position
Capacity	250 ml × 08 tubes	250 ml × 15 tubes	250 ml × 08 tubes	250 ml × 15 tubes
Heating Block	Aluminium			
Temperature Range	Ambient to 180°C			
Temperature Accuracy	±1°C		±10°C	
Display	Front GRP control panel with Graphic LCD		LED	
Graphical representation of time and temp	Yes		No	
Two point factory calibration	Yes			
PID autotune	Yes			
User presets	Yes			
Process Timer	0 - 999 min			
Temperature Control	Yes with Set value and Present value			
Time Control	Yes with Set value and Present value			
Connectivity to Printer	Yes		No	
Connectivity to PC	Yes		No	
Power consumptions	1400W	1800 W	1200W	1600W
Current Consumption	6 A	8 A	6 A	8 A
Unit External Dimensions (W × D × H)	(414 × 414 × 283)mm		(414 × 414 × 283)mm	
HSN Code	84198990			
Ordering Code	BLFACOD 08200000000	BLFACOD 15200000000	BLFACOD 08000000000	BLFACOD 01500000000
Prices / Piece	On Request			

Description	Ordering Code	Pack Size	Prices / Piece
COD air condensers	BLMACND100 CODSAC00	5	7,480.00
COD digestion vessels	BLMATUB100CODSGT20	5	6,660.00

Note : Digestion vessels and air condensers are provided by default with the unit

Fat Determination by Soxhlet Extraction

Delivering classical solutions with modernized approach for fat extraction



Technical Data & Ordering Information

Model Name	SOX012	SOX015	SOX062	SOX065
Positions	1	1	6	6
Flask Capacity (ml)	250	500	250	500
Extractor capacity (ml)	100	200	100	200
Display Timer	1-999 min			
Dimension (W × D × H) mm	200 × 300 × 800		1050 × 300 × 800	
Weight (Kgs)	7		15	
Power (W)	400 W		2400 W	
HSN Code	84198990			
Ordering Code	BLFRSOX 0120000000	BLFRSOX 0150000000	BLFRSOX 0620000000	BLFRSOX 0650000000
Price / Piece	On Request			

Accessories

Description	Ordering Code	Prices / Piece
SOX012 with Stand ASM (Entire assembly without glass parts)	BLAASOX01210000000	17,950.00
SOX015 with Stand ASM (Entire assembly without glass parts)	BLAASOX01510000000	19,010.00
SOX062 with Stand ASM (Entire assembly without glass parts)	BLAASOX06200000001	70,160.00
SOX065 with Stand ASM (Entire assembly without glass parts)	BLAASOX06500000001	80,610.00
SOXHLET 100 ML EXTRACTOR	BLA0SOXEXT10044327	5,500.00
SOXHLET 200ML EXTRACTOR	BLA0SOXEXT20048394	5,810.00
SOXHLET CONDENSER FOR 100ML EXT V2 ACCS	BLA0CON000SOX100V2	7,330.00
SOXHLET CONDENSER FOR 200ML EXT V2 ACCS	BLA0CON000SOX200V2	7,970.00

Flasks

All laboratories need Flasks of different types. **BOROSIL Scientific** offers a wide range of Flasks for a variety of applications such as boiling, culture, distilling, Erlenmeyer, Filtering, Iodine, and Kjeldahl. Choose one to suit your needs.

BOROSIL Scientific brand Flasks are designed to deliver the best combination of thermal shock resistance, physical strength and resistance to chemical attack. They are made so as to withstand the demands of the modern laboratory. Flasks with interchangeable joints are particularly suitable for all glass apparatus assemblies.

BOROSIL Scientific offers the interchangeable joints most commonly specified for a particular capacity. Tube Adaptors Category Nos. 8800 and 8820 can be used to connect the flask with a particular size joint to any other apparatus having a different size joint.

Made from 3.3 Low Expansion Borosilicate Glass



Please contact CT Enterprises for quotation.

Email: sales@ctenterprises.in | Phone: +91 8977721310

4060 - FLAT BOTTOM FLASK

Narrow Mouth

- Complies with IS 1381 (Part - I), ISO 1773 **with ISI Mark**
- Uniform wall thickness distribution makes these flasks ideal for heating
- All sizes have a durable matt-finished enamelled area for marking

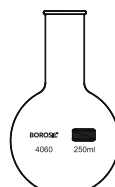

Product Code	Capacity ml	Approx O.D. x Height mm	Approx Neck O.D. mm	Quantity Per Case	Price / Piece ₹
4060009	25*	42 x 90	20	50	125.00
4060012	50	51 x 90	26	50	145.00
4060016	100	64 x 105	26	80	155.00
4060018	150*	75 x 132	28	10	175.00
4060021	250	85 x 140	34	80	185.00
4060022	300*#	88 x 160	24	20	275.00
4060024	500	105 x 165	34	40	305.00
4060029	1000	131 x 190	42	20	480.00
4060030	2000	166 x 230	50	2	910.00
4060031	3000*	186 x 300	50	4	2580.00
4060033	5000*	224 x 320	58	2	3785.00
4060034	6000	236 x 315	65	1	5470.00
4060038	10000	279 x 360	65	1	8835.00
4060A38	10000	279 x 390	65	1	8835.00
4060040	20000*	350 x 495	78	1	14710.00

* Not covered in standards

Suitable for use in Polenske Apparatus

4100 - FLAT BOTTOM FLASK

Narrow Mouth, Short Neck With I/C Joint

- Uniform wall thickness distribution makes these Flasks ideal for heating
- All sizes have a durable matt-finished enamelled area for marking
- Equipped with interchangeable joint
- The flat base ensures that the Flask can be placed down even without the supporting ring



Product Code	Capacity ml	Interchangeable Joint	Approx Height mm	Quantity Per Case	Price / Piece ₹
4100018	150	24 / 29	115	5	290.00
4100021	250	24 / 29	130	5	310.00
4100024	500	24 / 29	160	5	465.00
4100029	1000*	34 / 35	288	2	590.00
4100030	2000*	34 / 35	321	2	1050.00
4100031	3000*	34 / 35	345	2	2865.00
4100033	5000*	34 / 35	381	2	4655.00

* These are specific flasks with long neck 34/35 joint used in jewellery manufacturers

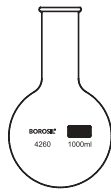

4260 - ROUND BOTTOM FLASK Narrow Mouth

- Complies with IS 1381 (Part I), ISO 1773 **with ISI Mark**
- Uniform wall thickness distribution makes these Flasks ideal for heating
- All sizes have a durable matt-finished enamelled area for marking

Product Code	Capacity ml	Approx O.D. x Height mm	Approx Neck O.D. mm	Quantity Per Case	Price / Piece ₹
4260009	25*	42 x 90	22	50	125.00
4260012	50	51 x 95	26	70	140.00
4260016	100	64 x 110	26	50	155.00
4260018	150*	75 x 137	28	10	175.00
4260021	250	85 x 143	34	80	175.00
4260024	500	105 x 168	34	40	305.00
4260029	1000	131 x 200	42	20	415.00
4260030	2000	166 x 240	51	2	920.00
4260031	3000*	187 x 305	50	2	2530.00
4260033	5000*	224 x 350	58	2	3745.00
4260034	6000	236 x 330	65	1	4890.00
4260038	10000	279 x 380	65	1	7820.00
4260040	20000*	350 x 505	78	1	14650.00

* Not covered in standards

LABQUEST
BY BOROSIL®

Still and Stirred Oil Baths

The oil bath is Constructed entirely of stainless steel, the Precision Oil Bath provides controlled heating up to 240°C. It is designed for still and stirred applications, offering a temperature accuracy of +1°C. The bath is insulated for user safety and equipped with overshoot control. Additionally, it can be used with water.

- Made from stainless steel
- Perforated base plate and supplied with lid
- Temperature control of either internal or external with a PT 100 probe
- Cylindrical interior tank
- Small footprint
- Microprocessor PID control
- Available with an inbuilt stirrer option for uniform heat transfer

Call or Write to us

Email id: lab.support@borosil.com
Toll Free Number: 1800 224 551



For more details please refer page no. 301

4265 - DISSOLUTION E-FLASK

Clear, USP, With Certificate

- Designed for dissolution apparatus with side cut, as per USP
- Vessels conforms to all requirements of USP Ch. 711, provided with certificate
- Smooth hemispherical base with no flaws or defects, straight sides and a flat flange
- Graduated in intervals of 50 ml
- Ideal for Dissolution Apparatus for determining the dissolution characteristics of drugs in capsules and tablets



Product Code	Capacity ml	Approx O.D. x Height mm	Quantity Per Case	Price / Piece ₹
4265029	1000	131 x 173	6	3545.00

4267 - DISSOLUTION E-FLASK

Amber, USP, With Certificate

- Designed for dissolution apparatus with side cut, as per USP
- These vessels conform to all the requirements of USP Ch. 711, provided with certificate
- Smooth hemispherical base with no flaws or defects, straight sides and a flat flange
- Graduated in intervals of 50 ml
- Ideal for dissolution apparatus for determining the dissolution characteristics of drugs in capsules and tablets
- Coloured in Amber to protect light-sensitive material
- The Amber colour is applied only to the external surface to prevent contamination with the testing material



Product Code	Capacity ml	Approx O.D. x Height mm	Quantity Per Case	Price / Piece ₹
4267029	1000	131 x 173	6	6390.00

Flasks

4270 - DISSOLUTION D-FLASKS

- Designed for Dissolution Apparatus without side cut, with silicon ring, as per USP
- Vessels conforms to all requirements of USP Ch. 711, provided with certificate
- Smooth hemispherical base with no flaws or defects, straight sides and a flat flange
- Graduated in intervals of 50ml
- Ideal for determining the dissolution characteristics of drugs in capsules and tablets



Product Code	Capacity ml	Approx O.D. x Height mm	Quantity Per Case	Price / Piece ₹
4270029	1000	132 x 168	6	13025.00



4315 - PEAR SHAPE FLASK

With I/C Joint

- The conical shape makes them ideal for small scale reaction
- Large labelling field

Product Code	Capacity ml	Interchangeable Joint Size	Quantity Per Case	Price / Piece ₹
4315005	5	10 / 19	10	215.00
4315105	5	14 / 23	10	215.00
4315006	10	10 / 19	10	230.00
4315106	10	14 / 23	10	230.00
4315009	25	14 / 23	5	250.00
4315012	50	14 / 23	10	290.00



4320 - ROTARY EVAPORATOR FLASK

With I/C Joint

- Rota Vapour Flasks are used along with Rotary Evaporators
- Ideal for heating sensitive solvent solute combinations
- Facilitate the extraction of key components like odour, oil, drugs, natural extract and fragrance

Product Code	Capacity ml	Interchangeable Joint Size	Quantity Per Case	Price / Piece ₹
4320112	50	24 / 29	2	1290.00
4320012	50	29 / 32	2	1360.00
4320116	100	24 / 29	2	2045.00
4320016	100	29 / 32	2	2185.00
4320121	250	24 / 29	2	3080.00
4320021	250	29 / 32	2	3245.00
4320124	500	24 / 29	2	3520.00
4320024	500	29 / 32	2	3655.00
4320129	1000	24 / 29	2	6220.00
4320029	1000	29 / 32	2	6365.00
4320130	2000	24 / 29	2	8020.00
4320030	2000	29 / 32	2	8220.00

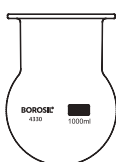

4330 - REACTION VESSEL FLASK

Wide Mouth With Flange

- These flasks have a spherical body with a neck of inner diameter 4 inches (approx 100 mm)
- The top is finely ground to ensure a leak-resistant fit with the cover

Product Code	Capacity ml	Approx Height mm	Quantity Per Case	Price / Piece ₹
4330029	1000	170	2	2380.00
4330030	2000	205	2	3230.00
4330033	5000	260	2	6750.00
4330038	10000	335	1	14255.00
4330040	20000	400	1	24525.00

4331 - LID FOR REACTION VESSEL FLASK

(Cat. No. 4330)

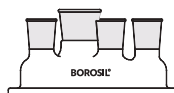

- Lids can be used with all of the above capacities of REACTION VESSEL FLASK (CAT. NO. 4330)

Product Code	Interchangeable Joint Size					Quantity Per Case	Price / Piece ₹
	Centre	Parallel	Side 50°	Side 10°	Side 15°		
4331Z97	19 / 26	19 / 26	24 / 29	19 / 26	-	2	5315.00
4331Z98	19 / 26	14 / 23	14 / 23	14 / 23	29 / 32	2	5315.00
4331Z99	29 / 32	14 / 23	14 / 23	14 / 23	29 / 32	2	5315.00



4380 - ROUND BOTTOM FLASK

Narrow Mouth, Short Neck With I/C Joint

- Uniform wall thickness distribution and the round - bottom shape make them ideal for heating
- Generally used in distillation and extraction processes
- Large labelling field

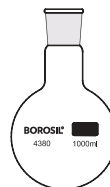

Product Code	Capacity ml	Approx Height mm	Interchangeable Joint	Quantity Per Case	Price / Piece ₹
4380A05	5	60	14 / 23	10	240.00
4380A06	10	65	14 / 23	10	240.00
4380A09	25	80	14 / 23	10	240.00
4380B09	25	77	19 / 26	10	250.00
4380A12	50	95	14 / 23	5	250.00
4380B12	50	95	19 / 26	5	250.00
4380C12	50	95	24 / 29	5	250.00
4380D12	50	95	29 / 32	5	250.00
4380E12	50	95	34 / 35	5	250.00
4380A16	100	120	14 / 23	20	250.00
4380B16	100	120	19 / 26	20	250.00
4380C16	100	120	24 / 29	20	250.00
4380D16	100	120	29 / 32	20	250.00
4380E16	100	120	34 / 35	20	250.00
4380A21	250	140	14 / 23	20	315.00
4380B21	250	140	19 / 26	20	315.00
4380C21	250	140	24 / 29	20	315.00
4380D21	250	140	29 / 32	20	315.00
4380E21	250	140	34 / 35	20	315.00
4380A24	500	160	14 / 23	10	450.00
4380B24	500	160	19 / 26	10	450.00
4380C24	500	160	24 / 29	10	495.00
4380D24	500	160	29 / 32	10	470.00
4380E24	500	160	34 / 35	10	470.00
4380A29	1000	190	19 / 26	10	615.00
4380B29	1000	190	24 / 29	10	615.00
4380C29	1000	190	29 / 32	10	615.00
4380D29	1000	190	34 / 35	10	615.00
4380E29	1000	190	45 / 40	10	615.00
4380F29	1000	190	55 / 44	10	580.00
4380A30	2000	230	24 / 29	4	1185.00
4380B30	2000	230	29 / 32	4	1185.00
4380C30	2000	230	34 / 35	4	1185.00
4380D30	2000	230	45 / 40	4	1185.00
4380A31	3000	265	24 / 29	4	3170.00
4380B31	3000	265	29 / 32	4	3170.00
4380C31	3000	265	34 / 35	4	3170.00
4380D31	3000	265	45 / 40	4	3170.00
4380E31	3000	265	55 / 44	4	3170.00
4380A33	5000	300	24 / 29	2	4850.00
4380B33	5000	300	29 / 32	2	4850.00
4380C33	5000	300	34 / 35	2	4850.00
4380D33	5000	300	45 / 40	2	4850.00
4380E33	5000	300	55 / 44	2	4850.00
4380A38	10000	385	34 / 35	1	9790.00
4380B38	10000	385	45 / 40	1	9790.00
4380C38	10000	385	55 / 44	1	9790.00
4380A40	20000	435	55 / 44	1	16945.00



Flasks



4381 - ROUND BOTTOM FLASK

2 Necks, Angular

- With Interchangeable Joints
- One neck is centred and vertical. The side neck is inclined at an angle of 20° to the vertical neck
- Uniform wall thickness distribution and the round-bottom shape make them ideal for heating
- The shape facilitates uniform heating
- Accessories, thermometer, column, dropping funnels, boiling capillaries, etc., can be fitted depending upon the application
- Generally used in distillation and extraction processes

Product Code	Capacity ml	Interchangeable Joint Size		Quantity Per Case	Price / Piece ₹
		Centre Neck	Side Neck		
4381A16	100	19 / 26	14 / 23	4	365.00
4381B16	100	24 / 29	14 / 23	4	365.00
4381C16	100	24 / 29	19 / 26	4	365.00
4381A21	250	24 / 29	14 / 23	4	485.00
4381B21	250	24 / 29	19 / 26	4	485.00
4381A24	500	24 / 29	14 / 23	4	700.00
4381B24	500	24 / 29	19 / 26	4	700.00
4381A29	1000	24 / 29	14 / 23	2	870.00
4381B29	1000	24 / 29	19 / 26	2	870.00
4381A30	2000	24 / 29	14 / 23	2	1540.00
4381B30	2000	24 / 29	19 / 26	2	1540.00
4381C30	2000	34 / 35	19 / 26	2	1610.00
4381A31	3000	34 / 35	19 / 26	2	3975.00
4381B31	3000	34 / 35	24 / 29	2	3975.00
4381A33	5000	34 / 35	19 / 26	1	5830.00
4381B33	5000	34 / 35	24 / 29	1	5830.00
4381A38	10000	34 / 35	24 / 29	1	10490.00
4381B38	10000	55 / 44	24 / 29	1	10490.00
4381A40	20000	55 / 44	24 / 29	1	17455.00

LABQUEST
BY BOROSIL®

Sphere Series

Mini Bath Reactor

Essential Powerhouse for Efficient Research

The Mini Bath Reactor is part of our Sphere Series, is designed for applications using spherical flask reactors. Equipped with a built-in heater and stirrer with united control, the Mini Bath Reactor offers ease of use and rapid setup, making it the go-to choice for demanding reactions.

Features

- Easy Stirrer height Adjustment
- Hassle-free vessel change and clamping
- Inbuilt heating system
- Tool-free operation
- Integrated control system
- Effortless oil drainage



We Automate Chemistry | PRICES ON REQUEST | For support mail us at process@borosil.com

For more details please refer page no. 374-375

4382 - ROUND BOTTOM FLASK

2 Necks, Parallel

- With Interchangeable Joints
- Both the necks are vertical. One neck is centred, while the other is the side neck
- Uniform wall thickness distribution and the round-bottom shape make them ideal for heating
- The shape facilitates uniform heating
- Accessories, thermometer, column, dropping funnels, boiling capillaries, etc., can be fitted depending upon the application
- Generally used in distillation and extraction processes



Product Code	Capacity ml	Interchangeable Joint Size		Quantity Per Case	Price / Piece ₹
		Centre Neck	Side Neck		
4382A16	100	19 / 26	14 / 23	4	365.00
4382B16	100	24 / 29	14 / 23	4	365.00
4382C16	100	24 / 29	19 / 26	4	365.00
4382A21	250	24 / 29	14 / 23	4	485.00
4382B21	250	24 / 29	19 / 26	4	485.00
4382A24	500	24 / 29	14 / 23	4	700.00
4382B24	500	24 / 29	19 / 26	4	700.00
4382A29	1000	24 / 29	14 / 23	2	825.00
4382B29	1000	24 / 29	19 / 26	2	870.00
4382A30	2000	24 / 29	14 / 23	2	1470.00
4382B30	2000	24 / 29	19 / 26	2	1540.00
4382C30	2000	34 / 35	19 / 26	2	1540.00
4382A31	3000	34 / 35	19 / 26	2	3975.00
4382B31	3000	34 / 35	24 / 29	2	3975.00
4382A33	5000	34 / 35	19 / 26	1	5830.00
4382B33	5000	34 / 35	24 / 29	1	5830.00
4382A38	10000	34 / 35	24 / 29	1	10490.00
4382B38	10000	55 / 44	24 / 29	1	10490.00
4382A40	20000	55 / 44	24 / 29	1	17460.00



4383 - ROUND BOTTOM FLASK 3 Necks, Angular

- With Interchangeable Joints
- The centred neck is vertical. The two side necks are 180° apart and are inclined at an angle of 20° to the vertical neck
- Uniform wall thickness distribution and round-bottom shape make them ideal for heating
- The shape facilitates uniform heating
- Accessories, thermometer, column, dropping funnels, boiling capillaries, etc. can be fitted depending upon the application
- Generally used in distillation and extraction processes

Product Code	Capacity ml	Interchangeable Joint Size			Quantity Per Case	Price / Piece ₹
		Centre Neck	Side Neck	Side Neck		
4383A16	100	19 / 26	14 / 23	14 / 23	4	510.00
4383B16	100	14 / 23	14 / 23	14 / 23	4	510.00
4383C16	100	24 / 29	14 / 23	14 / 23	4	510.00
4383D16	100	24 / 29	19 / 26	19 / 26	4	510.00
4383A21	250	19 / 26	14 / 23	14 / 23	4	645.00
4383B21	250	19 / 26	19 / 26	19 / 26	4	645.00
4383C21	250	24 / 29	14 / 23	14 / 23	4	645.00
4383D21	250	24 / 29	19 / 26	19 / 26	4	645.00
4383A24	500	19 / 26	14 / 23	14 / 23	4	960.00
4383B24	500	19 / 26	19 / 26	19 / 26	4	960.00
4383C24	500	24 / 29	14 / 23	14 / 23	4	1005.00
4383D24	500	24 / 29	19 / 26	19 / 26	4	1005.00
4383A29	1000	24 / 29	14 / 23	14 / 23	2	1190.00
4383B29	1000	24 / 29	19 / 26	19 / 26	2	1190.00
4383C29	1000	34 / 35	24 / 29	24 / 29	2	1190.00
4383D29	1000	34 / 35	19 / 26	19 / 26	2	1135.00
4383A30	2000	24 / 29	14 / 23	14 / 23	2	2250.00
4383B30	2000	24 / 29	19 / 26	19 / 26	2	2155.00
4383C30	2000	34 / 35	19 / 26	19 / 26	2	2250.00
4383D30	2000	34 / 35	24 / 29	24 / 29	2	2190.00
4383A31	3000	34 / 35	19 / 26	19 / 26	2	5120.00
4383B31	3000	34 / 35	24 / 29	24 / 29	2	5120.00
4383A33	5000	34 / 35	19 / 26	19 / 26	1	7245.00
4383B33	5000	34 / 35	24 / 29	24 / 29	1	7245.00
4383C33	5000	45 / 40	24 / 29	24 / 29	1	7245.00
4383A38	10000	34 / 35	19 / 26	19 / 26	1	13980.00
4383B38	10000	34 / 35	24 / 29	24 / 29	1	13980.00
4383C38	10000	45 / 40	24 / 29	24 / 29	1	13980.00
4383A40	20000	55 / 44	24 / 29	24 / 29	1	20965.00

4384 - ROUND BOTTOM FLASK

3 Necks, Parallel

- With Interchangeable Joints
- All the three necks are vertical. The two side necks are 180° apart
- Uniform wall thickness distribution and round-bottom shape make them ideal for heating
- The shape facilitates uniform heating
- Accessories, thermometer, column, dropping funnels, boiling capillaries, etc. can be fitted depending upon the application
- Generally used in distillation and extraction processes



Product Code	Capacity ml	Interchangeable Joint Size			Quantity Per Case	Price / Piece ₹
		Centre Neck	Side Neck	Side Neck		
4384A16	100	19 / 26	14 / 23	14 / 23	4	510.00
4384B16	100	14 / 23	14 / 23	14 / 23	4	510.00
4384C16	100	24 / 29	14 / 23	14 / 23	4	510.00
4384D16	100	24 / 29	19 / 26	19 / 26	4	510.00
4384A21	250	19 / 26	14 / 23	14 / 23	4	645.00
4384B21	250	19 / 26	19 / 26	19 / 26	4	645.00
4384C21	250	24 / 29	14 / 23	14 / 23	4	645.00
4384D21	250	24 / 29	19 / 26	19 / 26	4	645.00
4384A24	500	19 / 26	14 / 23	14 / 23	4	980.00
4384B24	500	19 / 26	19 / 26	19 / 26	4	920.00
4384C24	500	24 / 29	14 / 23	14 / 23	4	1005.00
4384D24	500	24 / 29	19 / 26	19 / 26	4	1005.00
4384A29	1000	24 / 29	14 / 23	14 / 23	2	1245.00
4384B29	1000	24 / 29	19 / 29	19 / 26	2	1190.00
4384C29	1000	34 / 35	24 / 29	24 / 29	2	1190.00
4384D29	1000	34 / 35	19 / 26	19 / 26	2	1135.00
4384A30	2000	24 / 29	14 / 23	14 / 23	2	2155.00
4384B30	2000	24 / 29	19 / 26	19 / 26	2	2155.00
4384C30	2000	34 / 35	19 / 26	19 / 26	2	2155.00
4384D30	2000	34 / 35	24 / 29	24 / 29	2	2190.00
4384A31	3000	34 / 35	19 / 26	19 / 26	2	5120.00
4384B31	3000	34 / 35	24 / 29	24 / 29	2	5120.00
4384A33	5000	34 / 35	19 / 26	19 / 26	1	7245.00
4384B33	5000	34 / 35	24 / 29	24 / 29	1	7245.00
4384C33	5000	45 / 40	24 / 29	24 / 29	1	7245.00
4384A38	10000	34 / 35	19 / 26	19 / 26	1	13980.00
4384B38	10000	34 / 35	24 / 29	24 / 29	1	13980.00
4384C38	10000	45 / 40	24 / 29	24 / 29	1	13980.00
4384A40	20000	55 / 44	24 / 29	24 / 29	1	20965.00



4385 - ROUND BOTTOM FLASK 4 Necks, Angular

- With Interchangeable Joints
- The centred neck is vertical. All the three side necks are inclined at an angle of 20° to the vertical neck
- The two side necks are 180° apart, and a third side neck is at 90° from the other two necks
- Uniform wall thickness distribution and round-bottom shape make them ideal for heating
- The shape facilitates uniform heating
- Accessories, thermometer, column, dropping funnels, boiling capillaries, etc. can be fitted depending upon the application
- Generally used in distillation and extraction processes

Product Code	Capacity ml	Interchangeable Joint Size		Quantity Per Case	Price / Piece ₹
		Centre Neck	Side Neck		
4385A12	50	24 / 29	24 / 29	4	710.00
4385A16	100	24 / 29	14 / 23	4	780.00
4385B16	100	24 / 29	19 / 26	4	815.00
4385A21	250	24 / 29	14 / 23	4	990.00
4385B21	250	24 / 29	19 / 26	4	990.00
4385A24	500	24 / 29	14 / 23	4	1405.00
4385B24	500	24 / 29	19 / 26	4	1405.00
4385C24	500	24 / 29	24 / 29	4	1405.00
4385D24	500	34 / 35	24 / 29	4	1465.00
4385A29	1000	24 / 29	14 / 23	2	1665.00
4385B29	1000	24 / 29	19 / 26	2	1740.00
4385C29	1000	24 / 29	24 / 29	2	1820.00
4385D29	1000	34 / 35	24 / 29	2	1820.00
4385A30	2000	24 / 29	14 / 23	2	2890.00
4385B30	2000	24 / 29	19 / 26	2	2890.00
4385C30	2000	34 / 35	19 / 26	2	2890.00
4385D30	2000	34 / 35	24 / 29	2	2890.00
4385A31	3000	34 / 35	19 / 26	2	6440.00
4385B31	3000	34 / 35	24 / 29	2	6440.00
4385A33	5000	34 / 35	19 / 26	1	8820.00
4385B33	5000	34 / 35	24 / 29	1	8820.00
4385A38	10000	55 / 44	24 / 29	1	15785.00
4385B38	10L	34 / 35	24 / 29	1	15785.00
4385A40	20000	55 / 44	24 / 29	1	23150.00

4386 - ROUND BOTTOM FLASK

4 Necks, Parallel

- With Interchangeable Joints
- All the four necks are vertical. The two side necks are 180° apart and the third neck is at 90° from the other two necks
- Four Necks, Centre Neck and Three Parallel Side Neck, with Interchangeable Joints
- Uniform wall thickness distribution and the round-bottom shape make them ideal for heating
- The shape facilitates uniform heating
- Accessories, thermometer, column, dropping funnels, boiling capillaries, etc. can be fitted depending upon the application
- Generally used in distillation and extraction processes



Product Code	Capacity ml	Interchangeable Joint Size		Quantity Per Case	Price / Piece ₹
		Centre Neck	Side Neck		
4386A12	50	24 / 29	24 / 29	4	710.00
4386A16	100	24 / 29	14 / 23	4	780.00
4386B16	100	24 / 29	19 / 26	4	815.00
4386A21	250	24 / 29	14 / 23	4	990.00
4386B21	250	24 / 29	19 / 26	4	990.00
4386A24	500	24 / 29	14 / 23	4	1340.00
4386B24	500	24 / 29	19 / 26	4	1340.00
4386C24	500	24 / 29	24 / 29	4	1405.00
4386D24	500	34 / 35	24 / 29	4	1465.00
4386A29	1000	24 / 29	14 / 23	2	1740.00
4386B29	1000	24 / 29	19 / 26	2	1820.00
4386C29	1000	24 / 29	24 / 29	2	1820.00
4386D29	1000	34 / 35	24 / 29	2	1820.00
4386A30	2000	24 / 29	14 / 23	2	2755.00
4386B30	2000	24 / 29	19 / 26	2	2890.00
4386C30	2000	34 / 35	19 / 26	2	2755.00
4386D30	2000	34 / 35	24 / 29	2	2890.00
4386A31	3000	34 / 35	19 / 26	2	6440.00
4386B31	3000	34 / 35	24 / 29	2	6440.00
4386A33	5000	34 / 35	19 / 26	1	8820.00
4386B33	5000	34 / 35	24 / 29	1	8820.00
4386A38	10000	55 / 44	24 / 29	1	15785.00
4386B38	10000	34 / 35	24 / 29	1	15785.00
4386A40	20000	55 / 44	24 / 29	1	23135.00

Flasks

4422 - CULTURE FLASK

Haffkine

- Complies with IS 7183
- The large, flat bottom surface ensures uniform culture growth
- Typically used for the preparation of culture in nutrient media



Product Code	Capacity ml	Approx O.D. x Height mm	Quantity Per Case	Price / Piece ₹
4422031	3000*	245 x 280	2	4150.00
4422032	4000	246 x 310	2	4575.00

*3000 ml not covered in standards





4620 - DISTILLING FLASK

With Side Arm

- Complies with IS 2620
- Uniform wall thickness distribution makes these Flasks ideal for heating
- Suitable for distillation process

Product Code	Capacity ml	Approx O.D. x Height mm	Approx Neck O.D. mm	Quantity Per Case	Price / Piece ₹
4620016	100	65 x 210	22	4	390.00
4620017	*125	69 x 215	22	4	385.00
4620021	250	87 x 230	25	4	640.00
4620024	500	110 x 250	28	4	755.00
4620029	1000	138 x 305	34	4	910.00

* Specification as per the Institute of Petroleum Standard No. IP 123/64



4621 - DISTILLING FLASK

With I/C Joint

- Distilling with I/C joint 19/26 as per ASTM D86

Product Code	Capacity ml	Approx O.D.xHeight mm	Approx Neck I. D.	Inter-changeable Joint	Quantity Per Case	Price / Piece ₹
4621017	125	69 x 218	19	19 / 26	20	605.00

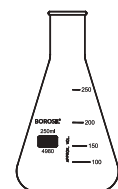

4980 - ERLENMEYER (CONICAL) FLASK

Narrow Mouth, With Rim

- Complies with IS 1381(Part I), DIN / ISO 1773 **with ISI Mark**
- Uniform wall thickness distribution makes these flasks ideal for heating
- The conical form makes them suitable for mixing liquids
- The easy-to-read scale and large labelling field facilitate easy marking
- Graduated from 25 ml to 5000 ml

Product Code	Capacity ml	Approx O.D. x Height mm	Approx Neck O.D. mm	Quantity Per Case	Price / Piece ₹
4980006	10*	37 x 60	15	30	115.00
4980009	25	42 x 75	22	40	120.00
4980012	50	51 x 90	22	100	120.00
4980016	100	64 x 105	22	100	125.00
4980017	125*	66 x 110	28	100	145.00
4980018	150*	72 x 124	28	100	150.00
4980021	250	85 x 145	34	40	185.00
4980024	500	105 x 180	34	40	265.00
4980029	1000	131 x 220	42	20	450.00
4980030	2000	166 x 280	52	20	790.00
4980031	3000	187 x 310	50	4	2260.00
4980033	5000	220 x 365	50	2	3495.00

4981 - ERLLENMEYER (CONICAL) FLASK

Long Neck Without Rim

- Complies with IS 1381(Part I), DIN / ISO 1773
- Uniform wall thickness distribution makes these flasks ideal for heating
- Long neck designed for cotton plugs and metal caps
- The conical form makes them suitable for mixing liquids
- The easy-to-read scale and large labelling field facilitate easy marking
- Ideal for microbial culture work

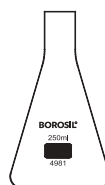

Product Code	Capacity ml	Approx O.D. x Height mm	Approx Neck O.D. mm	Quantity Per Case	Price / Piece ₹
4981021	250	78 x 154	27	10	255.00

4982 - ERLLENMEYER (CONICAL) FLASK

Without Rim

- Complies with IS 1381(Part I), DIN / ISO 1773
- Uniform wall thickness distribution makes these flasks ideal for heating
- The conical form makes them suitable for mixing liquids
- Designed without a rim for use in the shaker machine
- The easy-to-read scale and large labelling field facilitate easy marking
- Graduated from 25 ml to 5000 ml

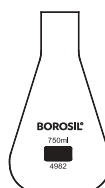

Product Code	Capacity ml	Approx O.D. x Height mm	Approx Neck O.D. mm	Quantity Per Case	Price / Piece ₹
4982027	750	114 x 210	42	10	570.00

Suitable for culture work, designed for use in shaker machine

4989 - ERLLENMEYER (CONICAL) FLASK

Narrow Mouth, With Rim, Amber

- Complies with IS 1381 (Part I), DIN / ISO 1773 **with ISI Mark**
- Uniform wall thickness distribution makes these flasks ideal for heating
- The conical form makes them suitable for mixing liquids
- The easy-to-read scale and large labelling field facilitate easy marking
- Graduated from 25 ml to 5000 ml
- Coloured in Amber to protect light-sensitive material
- The Amber colour is applied only to the external surface to prevent contamination with the testing material

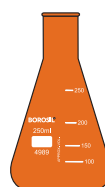

Product Code	Capacity ml	Approx O.D. x Height mm	Approx Neck O.D. mm	Quantity Per Case	Price / Piece ₹
4989016	100	64 x 105	22	10	235.00
4989018	150*	72 x 124	28	10	275.00
4989021	250	85 x 145	34	10	370.00
4989024	500	105 x 180	34	10	590.00
4989029	1000	131 x 220	42	10	995.00

* Not covered in standards

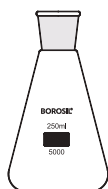

5000 - ERLENMEYER (CONICAL) FLASK

Narrow Mouth, With I/C Joint

- Complies with IS 1381(Part II), DIN / ISO 4797
- Equipped with interchangeable joints
- Uniform wall thickness distribution makes these flasks ideal for heating
- The conical form makes them suitable for mixing of liquids
- The easy-to-read scale and large labelling field facilitate easy marking

Product Code	Capacity ml	Interchangeable Joint	Quantity Per Case	Price / Piece ₹
5000009	25	14 / 23	10	230.00
5000012	50	19 / 26	10	240.00
5000016	100	24 / 29	10	290.00
5000021	250	24 / 29	10	305.00
5000024	500	24 / 29	5	440.00



5015 - TILT MEASURE

- Ideal for dispensing fixed volume of liquid
- Easy to use
 - Tilt the unit backward to fill
 - Tilt the unit forward to dispense
- Accuracy + 5% can be achieved

Product Code	Capacity ml	Flask Capacity ml	Quantity Per Case	Price / Piece ₹
5015005	5	100	5	1070.00
5015006	10	250	5	1120.00
5015008	20	250	10	1255.00
5015009	25	250	10	1340.00
5015012	50	250	10	1590.00



5019 - ERLENMEYER (CONICAL) FLASK

Narrow Mouth, With I/C Joint & Glass Stopper, Amber

- Complies with IS 1381 (Part II), DIN / ISO 4797
- Equipped with interchangeable joints
- These flasks can be closed with a glass stopper
- Uniform wall thickness distribution makes these flasks ideal for heating
- While heating stopper should be removed
- The conical form makes them suitable for mixing liquids
- Coloured in Amber to protect light-sensitive material
- The Amber colour is applied only to the external surface to prevent contamination with the testing material

Product Code	Capacity ml	Interchangeable Joint	Quantity Per Case	Price / Piece ₹
5019009	25	14 / 23	10	445.00
5019012	50	19 / 26	10	465.00
5019016	100	24 / 29	20	570.00
5019021	250	24 / 29	20	705.00
5019024	500	24 / 29	10	1155.00

5020 - ERLLENMEYER (CONICAL) FLASK

Narrow Mouth, With I/C Joint & Glass Stopper

- Equipped with interchangeable joints
- These flasks can be closed with a glass stopper
- The conical form makes them suitable for mixing of liquid
- While heating stopper should be removed



Product Code	Capacity ml	Interchangeable Joint	Quantity Per Case	Price / Piece ₹
5020009	25	14 / 23	10	275.00
5020012	50	19 / 26	10	335.00
5020016	100	24 / 29	20	405.00
5020021	250	24 / 29	20	425.00
5020024	500	24 / 29	10	640.00
5020029	1000	29 / 32	10	935.00
5020030	2000	29 / 32	10	1215.00

5021 - ERLLENMEYER (CONICAL) FLASK

With Screw Cap

- Supplied with PP screw cap autoclavable at 121°C
- The conical form makes them suitable for mixing of liquids



Product Code	Capacity ml	Neck Specification	Quantity Per Case	Price / Piece ₹
5021016	100	GL 25	20	355.00
5021018	150	GL 25	20	405.00
5021021	250	GL 45	20	465.00
5021024	500	GL 45	10	600.00
5021029	1000	GL 45	10	1110.00
5021030	2000	GL 45	10	1580.00
5021033	5000	GL 45	2	7430.00

5025 - ERLLENMEYER (CONICAL) FLASK

Baffled Bottom, With Screw Cap

- Supplied with screw cap made of polypropylene, autoclavable at 121°C
- Exhibits four baffled indents to provide consistent agitation and optimum aeration
- Optimum clarity for making critical observations
- Chemically inert and resistance to sodium leaching does not cause any pH changes in the liquid it is holdin
- Ideal culture vessel for microbial culture preparations, enzymatic dissociation of tissues, culturing of suspension cells for biopharma applications, plant cell culturing

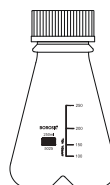

Product Code	Capacity ml	Neck Specification	Quantity Per Case	Price / Piece ₹
5025021	250	GL 45	10	2600.00
5025024	500	GL 45	10	3170.00
5025029	1000	GL 45	10	4465.00
5025030	2000	GL 45	10	5485.00

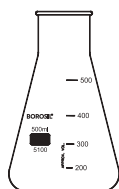

5100 - ERLENMEYER (CONICAL) FLASK Wide Mouth

- Complies with IS 1381 /ISO 1773
- Uniform wall thickness distribution makes these flasks ideal for heating
- The conical form makes them suitable for mixing of liquids
- The easy-to-read scale and large labelling field facilitate easy marking
- Designed with a wide neck that makes cleaning and filling easier

Product Code	Capacity ml	Approx O.D. x Height mm	Approx Neck O.D. mm	Quantity Per Case	Price / Piece ₹
5100016	100	64 x 105	34	20	145.00
5100021	250	85 x 142	50	30	200.00
5100024	500	105 x 175	50	20	305.00
5100029	1000	130 x 220	56	10	540.00

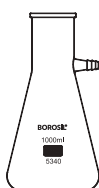

5340 - FILTER FLASK With Glass Tubulation

- These flasks are blown in special moulds
- The shape is designed to impart maximum mechanical strength
- The neck finish is designed for strength and to ensure good stopper fit
- Ideal for use with Bucher Funnel Category No. 36060 and Gooch Crucible
- No. 32060 with Sintered Discs that have different porosities

Product Code	Capacity ml	Approx O.D. x Height mm	Quantity Per Case	Price / Piece ₹
5340012	50	52 x 86	30	295.00
5340016	100	70 x 105	20	440.00
5340021	250	85 x 155	10	645.00
5340024	500	105 x 185	20	775.00
5340029	1000	135 x 235	10	1175.00
5340030	2000	165 x 270	4	2380.00
5340033	5000	240 x 450	2	8490.00
5340038	10000*	236 x 420	1	14765.00
5340040	20000*	295 x 538	1	25820.00

* These flasks are bottle shaped



5400 - IODINE FLASK With I/C Glass Stopper

- These flasks are made especially for the determination of Iodine value according to the methods of ASTM D-29
- Supplied Interchangeable Stopper
- Large labelling field for easy marking
- The handle of the stopper projects above the liquid seal, facilitating its removal

Product Code	Capacity ml	Interchangeable Joint Size	Quantity Per Case	Price / Piece ₹
5400016	100	24 / 29	10	335.00
5400021	250	24 / 29	10	420.00
5400024	500	24 / 29	10	530.00

5420 - KJELDAHL FLASK

- Designed with a tooled neck for greater strength and a better stopper fit
- These flasks are specially designed for nitrogen/protein determination as per the Kjeldahl method



Product Code	Capacity ml	Approx O.D. x Height mm	Quantity Per Case	Price / Piece ₹
5420006	10	30 x 180	10	145.00
5420010	30	40 x 180	10	210.00
5420016	100	61 x 210	10	270.00
5420022	300	82 x 298	10	440.00
5420024	500	103 x 325	10	855.00
5420028	800	116 x 375	10	1040.00



5430 - KJELDAHL FLASK

With I/C Joint

- Designed with a tooled neck for greater strength and better stopper fit
- These flasks are specially designed for nitrogen/protein determination as per Kjeldahl method.
- The flask with 500ml capacity is a part of Ammonia Distilling Apparatus Category No. 3340



Product Code	Capacity ml	Approx O.D. x Height mm	Interchangeable Joint Size	Quantity Per Case	Price / Piece ₹
5430024	500	103 x 325	24 / 29	10	1070.00
5430028	800	116 x 375	24 / 29	10	1185.00



Glass Apparatus as per *Pharmacopoeia*

Arsenic
Apparatus

Methoxy
Apparatus

Sodium Alginate
Assembly

Oxygen Combustion
Flask

Sulphur Dioxide
Assembly

Dean & Stark
Apparatus

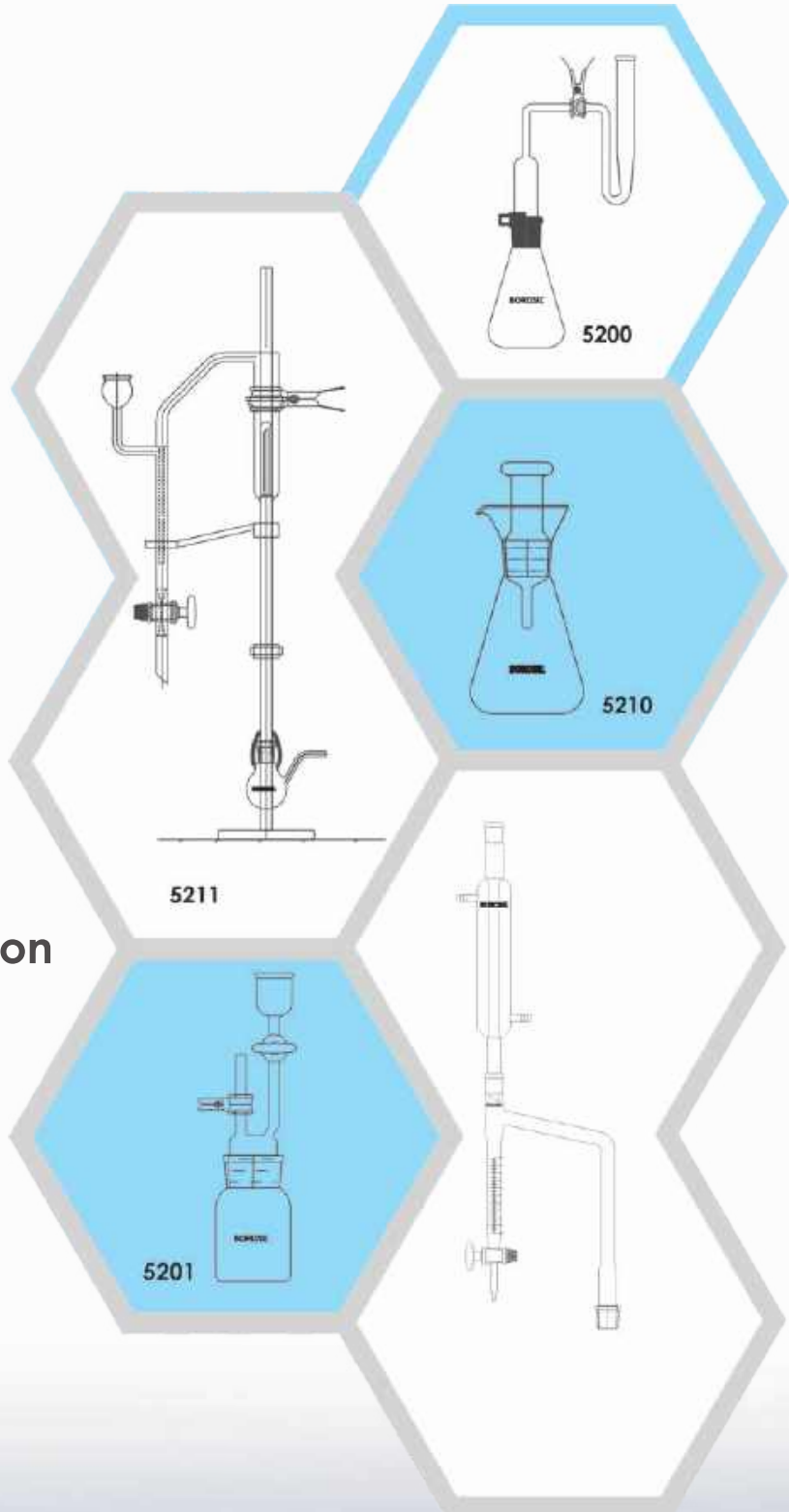

Please contact CT Enterprises for quotation.

Email: sales@ctenterprises.in | Phone: +91 8977721310

5200 - ARSENIC DETERMINATION APPARATUS AS PER USP

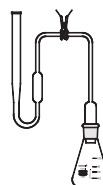

Product Code	Quantity Per Case	Price / Piece ₹
5200001	1	4510.00
Spare parts available on request		



5201 - ARSENIC DETERMINATION APPARATUS GUTZEIT



Product Code	Quantity Per Case	Price / Piece ₹
5201001	1	4510.00
Spare parts available on request		



Pharmacopoeial
Products

5202 - ARSENIC DETERMINATION APPARATUS AS PER BP



Product Code	Quantity Per Case	Price / Piece ₹
5202001	1	3310.00
Spare parts available on request		





5203 - ARSENIC DETERMINATION APPARATUS AS PER IP

Product Code	Quantity Per Case	Price / Piece ₹
5203001	1	2760.00

Spare parts available on request



5204 - ARSENIC DETERMINATION APPARATUS AS PER IS

Product Code	Quantity Per Case	Price / Piece ₹
5204001	1	3310.00

Spare parts available on request

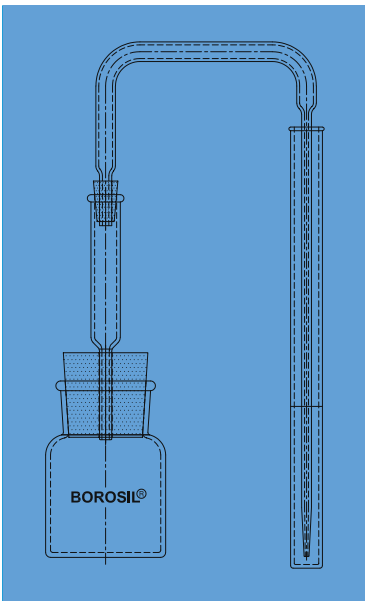

5205 - ARSENIC DETERMINATION APPARATUS AS PER JP

Product Code	Quantity Per Case	Price / Piece ₹
5205001	1	3430.00

Spare parts available on request

5206 - ARSENIC DETERMINATION APPARATUS AS PER EP

Product Code	Quantity Per Case	Price / Piece ₹
5206001	1	4055.00
Spare parts available on request		

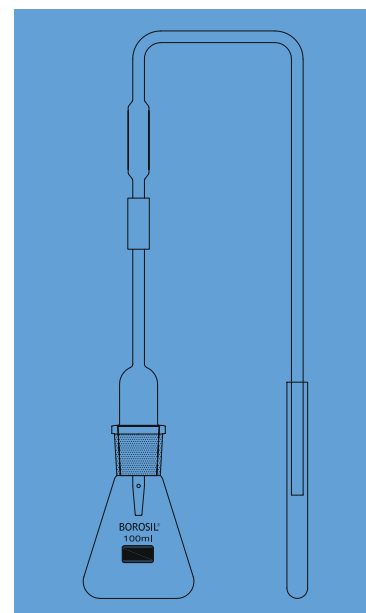

5210 - OXYGEN COMBUSTION FLASK AS PER USP

- Complies to ASTM E205 - 96
- Used for the determination of bromine, chlorine, iodine and sulphur

Product Code	Capacity ml	Quantity Per Case	Price / Piece ₹
5210022	300	1	58245.00
5210024	500	1	63250.00
Spare parts available on request			

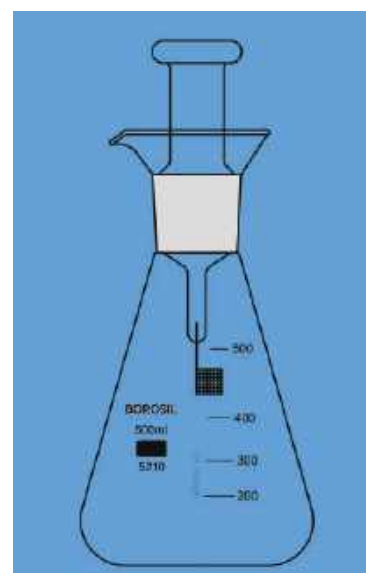

Pharmacopoeial Products

5211 - METHOXY DETERMINATION ASSEMBLY AS PER USP

Product Code	Quantity Per Case	Price / Piece ₹
5211024	1	13800.00
Spare parts available on request		

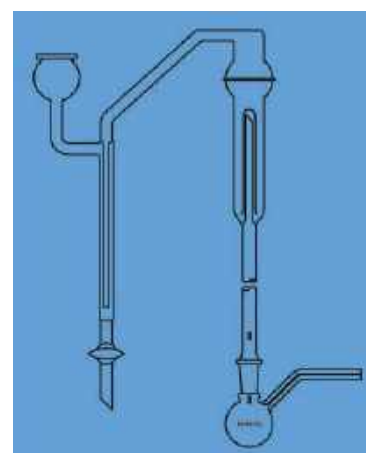

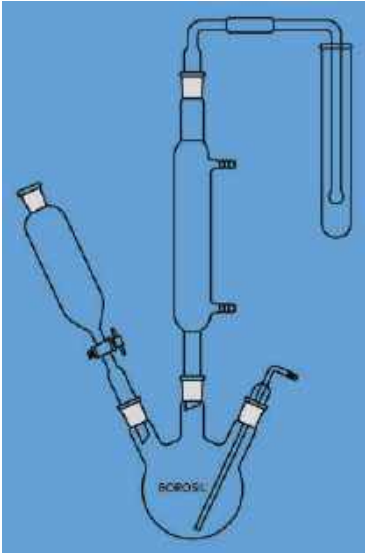

5212 - SULPHUR DI-OXIDE ASSEMBLY AS PER USP

Product Code	Quantity Per Case	Price / Piece ₹
5212024	1	17655.00
Spare parts available on request		

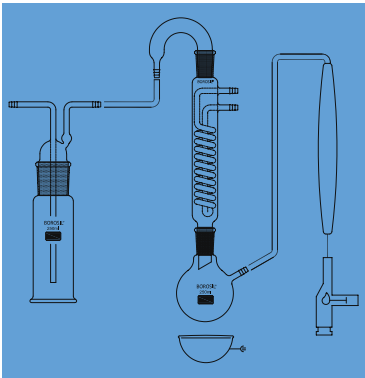

5215 - SODIUM ALGINATE ASSEMBLY AS PER USP

Product Code	Quantity Per Case	Price / Piece ₹
5215021	1 set	31965.00
Spare parts available on request		

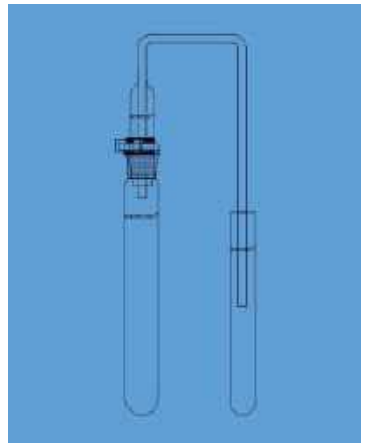

5216 - SODIUM BICARBONATE ASSEMBLY

Product Code	Quantity Per Case	Price / Piece ₹
5216001	2 sets	1355.00

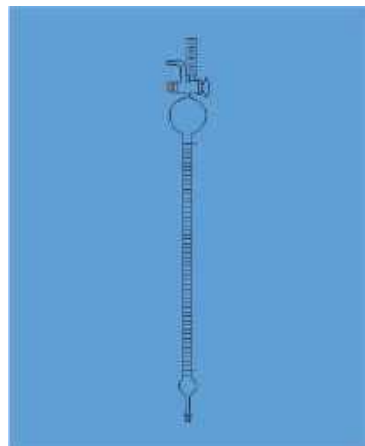

5217 - LUNGE NITROMETER

Product Code	Quantity Per Case	Price / Piece ₹
5217001	2 sets	6985.00

5218 - Carbonate Assembly

Product Code	Quantity Per Case	Price / Piece ₹
5218001	1 set	6100.00

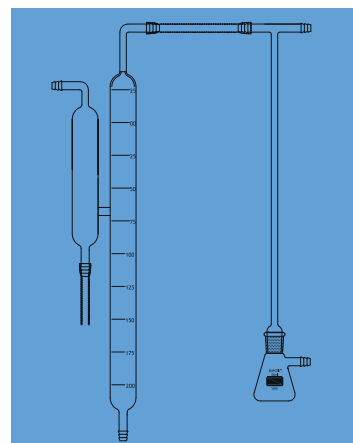

5219 - Gas Washing Apparatus

Product Code	Quantity Per Case	Price / Piece ₹
5219001	1 set	14545.00

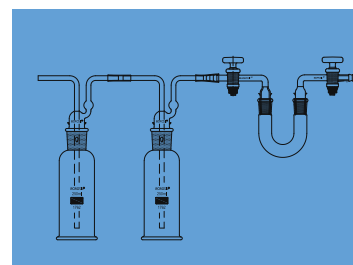

BOROSIL[®]
Scientific

BORO PURE
Filtration Products

Filtration
Products



Please contact CT Enterprises for quotation.

Email: sales@ctenterprises.in | Phone: +91 8977721310

Made from 3.3 Low Expansion Borosilicate Glass



BOROSIL Scientific offers a complete solution for laboratory filtration applications with **BORO PURE** range of products.

BORO PURE Glass Filter Assembly is easy to clean and 100% autoclavable and reusable. It is made of 3.3 borosilicate glass with a sintered glass filter which is compatible with most of the organic solvents. All glass filter assembly is an environment friendly and cost effective device for filtration.

BORO PURE Filter membrane is a new offering which is a new offering which includes membrane for applications such as HPLC mobile phase filtration, analysis of particulate or biological contaminants, small volume filtration and sterile filtration of media and buffer.



Filtration Products

Please contact CT Enterprises for quotation.
Email: sales@ctenterprises.in | Phone: +91 8977721310

BORO PURE

Filtration Products

Glass Filtration Assembly

is a comprehensive collection of precision-engineered products designed to revolutionize laboratory filtration. From ground joint to GL45 universal adapters, this essential range ensures effortless, high quality filtration, meeting the needs of various applications with utmost ease and efficiency.

Made from 3.3 Low Expansion Borosilicate Glass



Please contact CT Enterprises for quotation.

Email: sales@ctenterprises.in | Phone: +91 8977721310

5350 - BOROPURE GLASS FILTRATION ASSEMBLY

- Available in two sizes - 47 mm and 90 mm
- Entire assembly consists of:
 1. Glass Funnel - Capacity: 300 ml / 1000 ml
 2. Filter Support Base with sintered glass filter - 47 mm/ 90 mm
 3. Glass Receiver Flask - 500 ml/1000 ml/2000 ml/5000 ml
 4. Aluminium Clamp - 47 mm / 90 mm
- Effective filtration area - 9.6 cm² for 47 mm and 45.5 cm² for 90 mm
- The filter support base design has an integral vacuum connection located above the filtrate drip to prevent contamination of the vacuum line from droplets
- Aluminium spring clamp is anodised for longer life
- Ideal for filtration of HPLC solvents and aqueous mobile phase solutions and buffers

Assembly

Product Code	Filter Support Base Size mm	Glass Funnel Capacity ml	Glass Receiver Flask Capacity ml	Aluminium Clamp mm	Quantity Per Case	Price / Piece ₹
5350024	47	300 ml	500	47	1	19545.00
5350029	47	300 ml	1000	47	1	20240.00
5350030	47	300 ml	2000	47	1	26580.00
5350033	90	1000 ml	5000 ml	90	1	71940.00
5350A29	90	1000 ml	1000 ml	90	1	On request

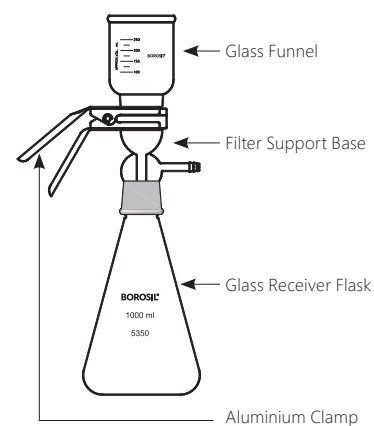

Spares For 47 MM Filter Assembly

Product Code	Capacity / Size	Description	Price / Piece ₹
5350124	500 ml	Glass Receiver Flask	4135.00
5350129	1000 ml	Glass Receiver Flask	5685.00
5350130	2000 ml	Glass Receiver Flask	12660.00
5350S01	300 ml	Glass Funnel	5060.00
5350S02	47 mm	Filter Support Base	7165.00
5350S03	47 mm	Aluminium Clamp	4200.00

Spares For 90 MM Filter Assembly

Product Code	Capacity /Size	Description	Price / Piece ₹
5350133	5000 ml	Glass Receiver Flask	10530.00
5350229	1000 ml	Glass Receiver Flask	On request
5350233	1000 ml	Glass Funnel	16015.00
5350333	90 mm	Filter Support Base	43495.00
5350433	90 mm	Aluminium Clamp	5790.00

HSN Code: 70179090 (for Assembly as well as spares)



5360 - BOROPURE GLASS FILTRATION ASSEMBLY With Silicone Stopper, 47 mm

- Entire assembly consists of:
 1. Glass Funnel - Capacity: 300 ml
 2. Filter Support Base with sintered glass filter - 47 mm
 3. Glass Receiver Flask - 1000 ml / 2000 ml
 4. Aluminium Clamp - 47 mm
 5. Silicone stopper: size # 8
- Effective filtration area - 9.6 cm² for 47 mm
- The filter support base design has an integral vacuum connection located above the filtrate drip to prevent contamination of the vacuum line from droplets
- Aluminium spring clamp is anodised for longer life
- The filtration base has a silicon stopper
- Facilitates analysis of particulate or biological contamination of vacuum filtering liquid

Assembly

Product Code	Filter Support Base Size mm	Glass Funnel Capacity ml	Glass Receiver Flask Capacity ml	Aluminium Clamp mm	Silicone stopper Size	Quantity Per Case	Price / Piece ₹
5360029	47	300 ml	1000	47	#8	1	18115.00
5360030	47	300 ml	2000	47	#8	1	19350.00

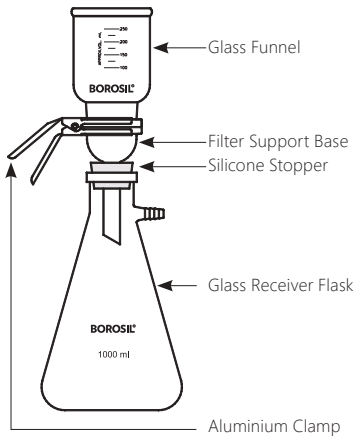

Spares For 47 MM Filter Assembly

Product Code	Capacity / Size	Description	Price / Piece ₹
5360129	1000 ml	Glass Receiver Flask	1195.00
5360130	2000 ml	Glass Receiver Flask	2425.00
5360S01	300 ml	Glass Funnel	5060.00
5360S02	47 mm	Filter Support Base	7165.00
5360S03	47 mm	Aluminium Clamp	4200.00
5360S05	#8	Silicone stopper, MOQ - Pack of 10 nos	450.00

Looking for Continuous Filtration of solvents?

Without the hassle of refilling the funnel ...

Try our new Glass Filtration Adapter



Product Code	Description	Size mm	Case Lot Nos	Price / Piece ₹
MISC530	Universal Filtration Adapter, Glass	47	5	On request

Compatible with all glass filtration assembly: 5350, 5360, 5380 and 5385



Scan to watch video

5370 - BOROPURE GLASS MICROFILTRATION ASSEMBLY

With Silicone Stopper, 25 mm

- Entire assembly consists of:
 1. Glass Funnel - Capacity: 15 ml
 2. Filter Support Base with sintered glass filter - 25 mm
 3. Glass Receiver Flask - 125 ml
 4. Aluminium Clamp - 25 mm
 5. Silicone stopper: size #5
- Effective filtration area - 2.2 cm² for 25 mm
- The filter support base design has an integral vacuum connection located above the filtrate drip to prevent contamination of the vacuum line from droplets
- Aluminium spring clamp is anodised for longer life
- The filtration base has a silicon stopper
- Ideal for small volume vacuum filtration for biological analysis or particulate contamination analysis.

Assembly

Product Code	Filter Support Base Size mm	Glass Funnel Capacity ml	Glass Receiver Flask Capacity ml	Aluminium Clamp mm	Silicone stopper Size	Quantity Per Case	Price / Piece ₹
5370017	25	15 ml	125	25	#5	1	9630.00

Spares For 25 MM Filter Assembly

Product Code	Capacity / Size	Description	Price / Piece ₹
5370S01	125 ml	Glass Receiver Flask	3870.00
5370S02	15 ml	Glass Funnel	2350.00
5370S03	25 mm	Filter Support Base	5390.00
5370S04	25 mm	Aluminium Clamp	2960.00
5370S05	#5	Silicone stopper, MOQ - Pack of 10 nos	375.00

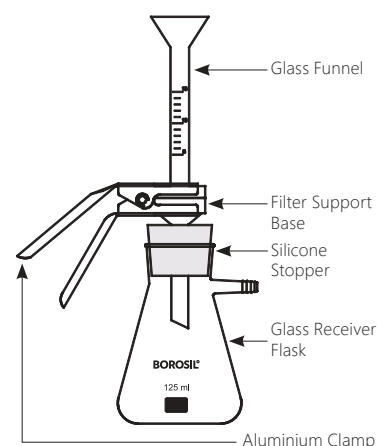

Filtration Products

Looking for Continuous Filtration of solvents?

Without the hassle of refilling the funnel ...

Try our new Glass Filtration Adapter



Scan to watch video





5380 - BOROPURE GLASS FILTRATION ASSEMBLY 47 mm, With Bottle

- Entire assembly consists of:
 1. Glass Funnel - Capacity: 300 ml / 1000 ml
 2. Filter Support Base with sintered glass filter - 47 mm / 90 mm
 3. Glass Bottle with PP Screw cap - 1000 ml / 2000 ml / 5000 ml
 4. Aluminium Clamp - 47 mm / 90 mm
- Effective filtration area - 9.6 cm² for 47 mm and 45.5 cm² for 90 mm
- The filter support base design has an integral vacuum connection located above the filtrate drip to prevent contamination of the vacuum line from droplets
- Aluminium spring clamp is anodised for longer life
- The final filtrate will be collected directly in a screw cap bottle and there is no need to transfer the filtrate again into a new container for storage
- Ideal for filtration of HPLC solvents and aqueous mobile phase solutions, sterile filtration of media and buffers

Assembly

Product Code	Filter Support Base Size mm	Glass Funnel Capacity ml	Glass Receiver Bottle Capacity ml	Aluminium Clamp mm	Quantity Per Case	Price per set ₹
5380029	47	300 ml	1000	47	1	18335.00
5380030	47	300 ml	2000	47	1	18930.00
5380033	90	1000 ml	5000	90	1	On Request

Spares For 47 MM Filter Assembly

Product Code	Capacity / Size	Description	Price / Piece ₹
5380129	1000 ml	Glass Receiver Bottle with GL 45 screw cap	3785.00
5380130	2000 ml	Glass Receiver Bottle with GL 45 screw cap	4865.00
5350S01	300 ml	Glass Funnel	5015.00
5380S02	47 mm	Filter Support Base	7790.00
5350S03	47 mm	Aluminium Clamp	4160.00

5385 - BOROPURE GLASS FILTRATION ASSEMBLY

With GL 45 Universal Adapter, 47mm

- The universal adaptor will connect directly to GL 45 bottle
- The final filtrate will be collected directly in a screw cap bottle and there is no need to transfer the filtrate again into a new container for storage
- Entire assembly consists of:
 1. Glass Funnel - Capacity: 300 ml / 1000 ml
 2. Filter Support Base with sintered glass filter - 47 mm
 3. GL 45 Filtration Adaptor
 4. Glass Bottle with PP Screw cap - 1000 ml / 2000 ml
 5. Aluminium Clamp - 47 mm
 6. Effective filtration area - 9.6 cm² for 47 mm
- The GL 45 universal adapter is made of polypropylene and has a vacuum connection and GL 45 threads
- Aluminium spring clamp is anodised for longer life
- Ideal for filtration of HPLC solvents and aqueous mobile phase solutions, sterile filtration of media and buffers

Product Code	Funnel Capacity (ml)	Filtration Support base size (mm)	Filtration adapter	Glass Bottle (ml)	Aluminium Clamp	Qty per case	Price / pc
5385029	300ml	47	GL 45	1000	47	1	18930.00
5385030	300ml	47	GL 45	2000	47	1	19520.00

Spares For 47 MM Filter Assembly

Product Code	Capacity / Size	Description	Price / Piece ₹
1501029	1000 ml	Glass Bottle with GL 45 screw cap	736.00
1501030	2000 ml	Glass Bottle with GL 45 screw cap	1313.00
5350S01	300 ml	Glass Funnel	5061.00
5360S02	47 mm	Filter Support Base	7166.00
5350S03	47 mm	Aluminium Clamp	4200.00
5385S01	GL 45	GL 45 Filtration Adapter	3085.00



Filtration Products

BOROPURE

Filtration Products

Stainless Steel Filtration Assembly

Sturdy and easy to clean SS Filtration assembly for laboratory applications like filtration of HPLC solvents, media, buffers and for microbiological analysis.

The Stainless Steel category offers a range of robust filtration solution designed for durability and efficiency. Explore Vacuum Filtration Assemblies and other sturdy products, carefully crafted to redefine your filtration experience., With compatibility for various applications and exceptional reliability, our Stainless Steel collection ensures superior filtration results you can rely on.



SS Filter Assembly
With Inbuilt Clamp



SS Filter Assembly
With External Clamp



SS Filter Assembly
Spin Lock Type
(No clamp required)



Please contact CT Enterprises for quotation.

Email: sales@ctenterprises.in | Phone: +91 8977721310

5330 - BOROPURE SS FILTER FUNNEL WITH INBUILT CLAMP, 47MM

- Made of SS 316
- Entire Assembly consists of:
 1. SS Funnel : 300ml / 500ml / 1L with inbuilt Clamp
 2. SS Filter Support Base
 3. SS Support Screen: 47mm, made of SS 316L
 4. Silicone Stopper: Size #8 for 300 ml & 500 ml funnel, #10 for 1L funnel
 5. Silicone Lid
 6. Silicone O ring

Product Code	Description	Funnel Capacity (ml)	Filter Support base diameter (mm)	Filtration Area (cm square)	Quantity per case	Price ₹
5330022	SS Filter Assembly, Inbuilt Clamp, 300ml	300	47	9.6	1	8165.00
5330024	SS Filter Assembly, Inbuilt Clamp, 500ml	500	47	9.6	1	9830.00
5330029	SS Filter Assembly, Inbuilt Clamp, 1000ml	1000	47	9.6	1	28600.00



Membrane not included with funnel

SS Filtration Products

5331 - BOROPURE SS FILTER FUNNEL WITH EXTERNAL CLAMP, 47MM

- Made of SS 316
- Entire Assembly consists of:
 1. SS Funnel : 300ml / 500ml / 1L with external Clamp
 2. SS Filter Support Base
 3. SS Support Screen: 47mm, made of SS 316L
 4. Silicone Stopper: Size #8 for 300 ml & 500 ml funnel, #10 for 1L funnel
 5. Aluminum Clamp: 47mm
 6. Silicone Lid

Product Code	Description	Funnel Capacity (ml)	Filter Support base diameter (mm)	Filtration Area (cm square)	Quantity per case	Price ₹
5331022	SS Filter Assembly, External Clamp, 300ml	300	47	9.6	1	19200.00
5331024	SS Filter Assembly, External Clamp, 500ml	500	47	9.6	1	26260.00
5331029	SS Filter Assembly, External Clamp, 1000ml	1000	47	9.6	1	51220.00



Membrane not included with funnel



Membrane not included with funnel

5332 - BOROPURE SS FILTER FUNNEL WITH SPIN-LOCK TYPE, 47MM

- Made of SS 316
- Entire Assembly consists of:
 1. SS Funnel : 300ml / 500ml / 1L With Spin-lock mechanism
 2. SS Filter Support Base
 3. SS Support Screen: 47mm, made of SS 316L
 4. Silicone Stopper: Size #8 for 300 ml & 500 ml funnel, #10 for 1L funnel
 5. Silicone Lid

Product Code	Description	Funnel Capacity (ml)	Filter Support base diameter (mm)	Filtration Area (cm square)	Quantity per case	Price ₹
5332022	SS Filter Assembly, Spin-lock type, 300ml	300	47	9.6	1	39480.00
5332024	SS Filter Assembly, Spin-lock type, 500ml	500	47	9.6	1	48360.00
5332029	SS Filter Assembly, Spin-lock type, 1000ml	1000	47	9.6	1	66040.00

5333 - BOROPURE SS VACUUM FILTRATION MANIFOLD



- Made of SS 316
- Valves made of PTFE
- Connection: 12mm
- Suitable for PP and Stainless Steel funnels with rubber stopper fittings

Product Code	Description	Stages	Quantity per case	Price ₹
5333003	3 Place SS Filtration manifold	3	1	43805.00
5333006	6 Place SS Filtration manifold	6	1	63960.00

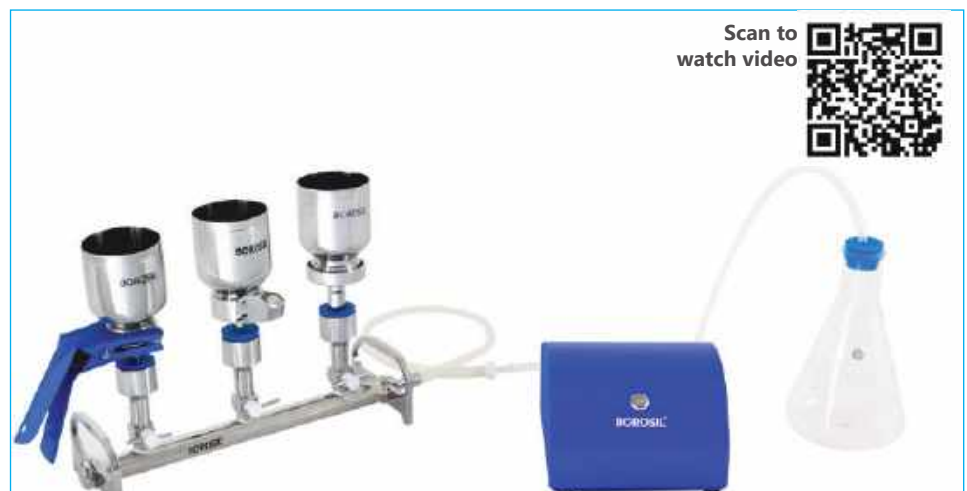

5334 - BOROPURE VACUUM FILTRATION PUMP

- Suitable for use with SS Manifold (5333)
- Oil-free diaphragm based pump
- Compact pump with high flow rate
- Material in contact with the liquid: Silicon, PTFE, SS316L (Connector) and Body Mild steel Powder Coated
- Dimensions: 18x18x12 cm
- Weight: 2.8kg
- Tubing connection: 8mm hose
- Vacuum: 300 mbar, can achieve maximum trans-membrane pressure of 400 mbar and flow rate 5 L/min
- Motor Power: 60w
- Noise: 45db
- Product includes:
- Main unit, Power Adaptor 2.5amp, 230 VAC, Power cord and 3x3 meter silicon tubing



Product Code	Description	Quantity per case	Price ₹
5334001	Vacuum Filtration Pump	1	1,24,800.00

5335 - FILTRATION ASSEMBLY WITH INBUILT PUMP

- Flow rate: 4.5L/min
- Motor Power: 60w 24 VDC
- Tubing connection: 8mm hose
- Material in contact with liquid filtered: Silicon, PTFE, SS 316L
- Compatible with SS, disposable and reusable funnels with suitable adapter



Scan to watch video



Product Code	Description	No of branches	Dimensions (LxWxH)(cm)	Weight (kg)	Quantity per case	Price ₹
5335001	1 place Filtration Manifold Assembly with inbuilt pump	1	8 × 8 × 6	2	1	On request
5335003	3 place Filtration Manifold Assembly with inbuilt pump	3	40 × 18 × 15	6	1	2,18,400
5335006	6 place Filtration Manifold Assembly with inbuilt pump	6	32 × 6 × 6	13	1	On request



5335ARF

Adapters for Filtration Assembly

Product Code	Description	Quantity per case	Price ₹
5335ARF	Adapter C1 (for reusable PP funnel)	1	8840.00
5335ARB	Adapter C2 (for Rubber stopper filter holder)	1	6240.00
5335ADF	Adapter C3 (for disposable sterile funnel)	1	5200.00
5335AST	Adapter C4 (for silicon tube)	1	4160.00



5335ADF

BORO PURE

Filtration Products

Membrane Filters

BORO PURE Membrane filters are used for applications such as HPLC mobile phase filtration, analysis of particulate or biological contaminants, small volume filtration of media and buffers.



Filtration
Products

Please contact CT Enterprises for quotation.

Email: sales@ctenterprises.in | Phone: +91 8977721310

5147 - BOROPURE CELLULOSE NITRATE MEMBRANE

Hydrophilic in nature and biologically inert

High retention and high flow rate

Available in two pore sizes - 0.22 micron and 0.45 micron

Autoclavable at 121°C for 30 mins for sterilization

Recommended for applications like clarification and sterilization of media, reagents and buffers, sterility testing, water testing, product and water microbiology

Tested for : Membrane integrity, Flow rate, Membrane thickness, Heat stability and Microbial Challenge Test



Product Code	Description	Pore size μm	Diameter mm	Membrane /pack Nos	Case lot	Price per pack ₹
514722N	Cellulose Nitrate Membrane, Non- sterile	0.22	47	100	5	1935.00
514745N	Cellulose Nitrate Membrane, Non- sterile	0.45	47	100	5	1935.00

* Sterile membranes available on Request

5247 - BOROPURE GRIDDED CELLULOSE NITRATE MEMBRANE

- Hydrophilic in nature and biologically inert
- High retention and high flow rate
- White membrane with black grids which make the colony counting easier
- Grids do not inhibit the growth of microorganisms
- Available in two pore sizes - 0.22 micron and 0.45 micron
- Autoclavable at 121°C for 30 mins for sterilization
- Recommended for applications like water testing, product and water microbiology
- Tested for : Membrane integrity, Flow rate, Membrane thickness, Heat stability, Microbial Challenge Test and Growth Inhibition



Filtration Products

Product Code	Description	Pore size μm	Diameter mm	Membrane /pack Nos	Case lot	Price per pack ₹
524722N	Gridded Cellulose Nitrate Membrane, Non- sterile	0.22	47	100	5	2135.00
524745N	Gridded Cellulose Nitrate Membrane, Non- sterile	0.45	47	100	5	2135.00
524722SE	Gridded Cellulose Nitrate Membrane, ETO sterilized	0.22	47	100	5	2625.00
524745SE	Gridded Cellulose Nitrate Membrane, ETO sterilized	0.45	47	100	5	2625.00

* Sterile membranes available on Request

5347 - BOROPURE NYLON-66 MEMBRANE HPLC Grade

- Hydrophilic in nature and biologically inert
- Wide chemical compatibility and resistant to strong solvents and alcohols
- Available in two pore sizes - 0.22 micron and 0.45 micron
- Autoclavable at 121°C for 30 mins for sterilization
- Recommended for applications like clarification of aqueous and organic HPLC mobile phase solvents, HPLC sample preparations
- Tested for : Membrane integrity, Flow rate, Membrane thickness, Heat stability, Fibre/ particle release and Extractables



Product Code	Description	Pore size μm	Diameter mm	Membrane /pack Nos	Case lot	Price per pack ₹
534722N	Nylon-66 Membrane, Non- sterile	0.22	47	100	5	2240.00
534745N	Nylon-66 Membrane, Non- sterile	0.45	47	100	5	2240.00

For membranes of other diameter and pore sizes, please contact our local sales representative

* Sterile membranes available on Request

Volumetric Flask

Volumetric Flasks is a laboratory glassware that is designed to hold a certain volume at a particular temperature and indicates the nominal volume, tolerance, precision class, relevant manufacturing standard etc. **BOROSIL Scientific** Volumetric Flasks are manufactured in a range of sizes that is capable of containing 1ml to 5,000ml of liquid,

it is very important to understand that for analysis which demands high precision, the selection of instruments is very vital. In cases where precision analysis is expected, only high accuracy instruments give the desired results. Most sophisticated automatic instruments can deliver high precision results, only if the volumetric ware used to prepare samples is accurate.

- Individually calibrated with automatic calibration process
- Strict quality control through all steps eliminate possible deviations from nominal volume
- Supplied with individual certificate which can be downloaded from our website
- Volumetric Flasks are supplied with plastic or solid glass stopper
- Real time with lower meniscus image in class A test certificate



Please contact CT Enterprises for quotation.

Email: sales@ctenterprises.in | Phone: +91 8977721310

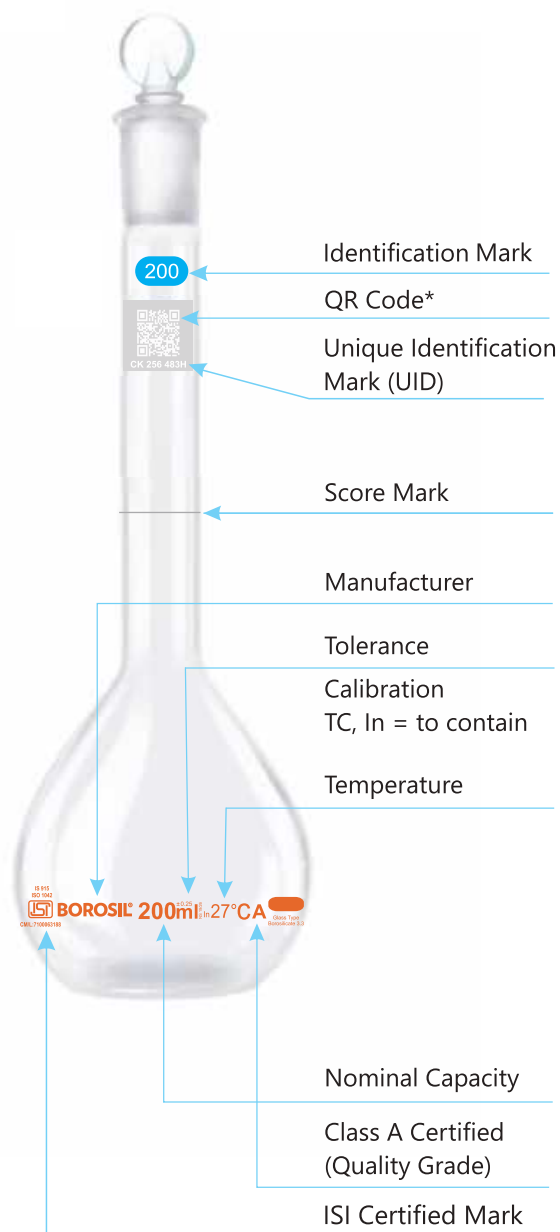

BOROSIL Scientific Volumetric Flasks are designed to give the best combination of thermal shock resistance, physical strength and resistance to chemical attack. They are made to withstand the demands of the modern laboratory and are particularly suitable for all glass apparatus assemblies.

Made from 3.3 Low Expansion Borosilicate Glass



At **BOROSIL Scientific** we understand that different needs require different solutions. Hence we offer our clients as wide range of flasks, designed to meet their individual requirements, while ensuring optimum quality.

Calibration

- Every Volumetric Flask is calibrated on fully automatic computer controlled calibration machine, eliminating the manual error in reading the meniscus, thereby giving more accurate volume.
- Each Volumetric Flask is individually calibrated and is provided with Unique Identification Number (UID) and supplied with individual Certificate

Printing

- All Volumetric Flasks are printed with permanent amber colour
- The amber Volumetric Flasks are printed with white ceramic enamel
- Printing is done using advanced printing technology and high quality organic enamels and inks to ensure finest printing quality

Please contact CT Enterprises for quotation.
 Email: sales@ctenterprises.in | Phone: +91 8977721310

Volumetric Flasks
 Funnels
 Gas Generator
 Jars & Kettles

Bothered filing
hard copies
**of calibration
certificates for long years?**



BOROSIL[®]
Scientific
is right here with a solution

PROUDLY MADE IN  **India**

Volumetric Flasks



QR Coded Volumetric Glassware

*For easy certificate download
by simple scanning of glassware*



Please contact CT Enterprises for quotation.

Email: sales@ctenterprises.in | Phone: +91 8977721310

How to download a Calibration Certificate using QR code ?

Borosil Scientific Mobile Application



- ▶ Download the the Borosil app from Android Playstore / iOS App Store
- ▶ Scan the QR code on the Volumetric Flask through your mobile and follow a few simple steps to download the Certificate

Borosil Scientific Website



- ▶ Logon to www.borosilscientific.com and enter the product certificate portal
- ▶ Scan the QR code on the Volumetric Flask using a 2D or 3D barcode scanner and follow a few simple steps to download the Certificate

Benefits of using QR coded Glassware

Permanent QR code marking with laser technology

QR code encodes the data required for identification and traceability of individual volumetric ware

- Company name
- Product Code and name
- Unique code
- Nominal and certified Volume
- Calibration details



- No more filing of hard copies of calibration certificates for long years
- Download the certificates by simple scanning of glassware and print as and when required
- Easy download of list of scanned glassware in excel format
- Saves time and hassle involved in maintaining the certificates
- Less usage of paper and better for the environment
- Readiness for audit

Please contact CT Enterprises for quotation.

Email: sales@ctenterprises.in | Phone: +91 8977721310

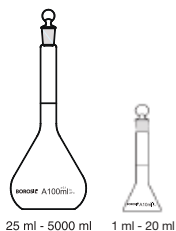

5640 - VOLUMETRIC FLASKS

Class A, Narrow Mouth, Clear, with Individual Calibration Certificate

- Complies with IS 815 / DIN - ISO 1042, Accuracy as per class A **with ISI Mark**
- Supplied with Interchangeable Solid Glass Stopper
- Each flask is marked with individual serial number and supplied with certificate of calibration traceable to National standards
- Amber enamel inscriptions
- Calibrated & certified at 27°C

Product Code	Capacity ml	Tolerance ± ml	Stopper Size	Quantity Per Case	Price / Piece ₹
5640001	1*	0.025	7 / 16	5	1210.00
5640002	2*	0.025	7 / 16	5	1210.00
5640005	5	0.025	10 / 19 #	5	1090.00
5640006	10	0.025	10 / 19 #	5	945.00
5640008	20	0.04	10 / 19	5	945.00
5640009	25	0.04	10 / 19	5	875.00
5640012	50	0.06	12 / 21	10	825.00
5640016	100	0.10	14 / 23	10	805.00
5640020	200	0.15	14 / 23	10	1140.00
5640021	250	0.15	14 / 23	10	1140.00
5640024	500	0.25	19 / 26	10	1490.00
5640029	1000	0.40	24 / 29	10	2185.00
5640030	2000	0.60	29 / 32	2	3545.00
5640033	5000	1.20	34 / 35	1	15180.00

- 1 ml to 20 ml supplied with trapezoidal shape for better stability
- # Stopper size as per Borosil Scientific Design
- * 1 ml & 2 ml without QR code



5641 - VOLUMETRIC FLASKS

Class B, Narrow Mouth, Clear

- Complies with IS 815 / DIN - ISO 1042, Accuracy as per class B **with ISI Mark**
- Supplied with interchangeable glass stopper
- Amber enamel inscriptions
- Calibrated at 27°C

Product Code	Capacity ml	Tolerance ± ml	Stopper Size	Quantity Per Case	Price / Piece ₹
5641001	1	0.05	7 / 16	10	405.00
5641002	2	0.05	7 / 16	10	360.00
5641005	5	0.05	10 / 19#	10	335.00
5641006	10	0.05	10 / 19#	10	315.00
5641008	20	0.08	10 / 19	10	315.00
5641009	25	0.08	10 / 19	10	310.00
5641012	50	0.12	12 / 21	10	335.00
5641016	100	0.20	14 / 23	10	370.00
5641020	200	0.30	14 / 23	10	435.00
5641021	250	0.30	14 / 23	10	450.00
5641024	500	0.50	19 / 26	10	630.00
5641029	1000	0.80	24 / 29	10	1035.00
5641030	2000	1.20	29 / 32	2	2155.00
5641033	5000	2.40	34 / 35	1	7710.00

- 1 ml to 20 ml supplied with trapezoidal shape for better stability
- Certified and Calibrated at 27°C
- # Stopper size as per Borosil Scientific Design

5643 - VOLUMETRIC FLASKS

Class A, Wide Mouth, Clear, with Individual Calibration Certificate

- Complies with IS 815 / DIN - ISO 1042, Accuracy as per class A **with ISI Mark**
- Supplied with Interchangeable Solid Glass Stopper
- Each flask is marked with individual serial number and supplied with certificate of calibration traceable to National standards
- Amber enamel inscriptions
- Specially designed wide mouth for testing bigger diameter tablet without making it in powder form
- Calibrated & certified at 27°C



Product Code	Capacity ml	Tolerance ± ml	Stopper Size	Quantity Per Case	Price / Piece ₹
5643005	5	0.04	12 / 21#	5	1085.00
5643006	10	0.04	12 / 21#	5	945.00
5643008	20	0.06	12 / 21	5	955.00
5643009	25	0.06	12 / 21	5	1040.00
5643A09	25*	0.06	14 / 23#	5	1020.00
5643012	50	0.10	14 / 23	10	1000.00
5643016	100*	0.10	19 / 26	10	1050.00
5643020	200*	0.15	19 / 26	10	1380.00
5643021	250*	0.15	19 / 26	10	1470.00
5643024	500*	0.25	24 / 29	10	1650.00
5643029	1000*	0.60	29 / 32	10	2270.00

- * Not covered in the standards
- 5 ml to 20 ml supplied with trapezoidal shape for better stability
- # 5 ml & 10 ml (# Stopper size as per borosil scientific design)



5645 - VOLUMETRIC FLASKS

Class A, ASTM, Narrow Mouth, Clear, with Individual Calibration Certificate, Neck size as per ASTM (Bulgy neck)

- Complies fully with ASTM E 288 standards - For both dimensions as well as tolerance
- Supplied with Interchangeable Solid Glass Stopper
- Each flask is marked with individual serial number and supplied with certificate of calibration traceable to National standards
- Amber enamel inscriptions
- Calibrated & certified at 20°C

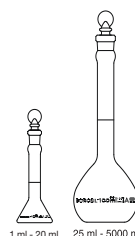

Product Code	Capacity ml	Tolerance ± ml	Stopper Size	Quantity Per Case	Price / Piece ₹
5645005	5	0.02	9	5	1220.00
5645006	10	0.02	9	5	1060.00
5645008	20*	0.03	9	5	1065.00
5645009	25	0.03	9	5	980.00
5645012	50	0.05	9	10	930.00
5645016	100	0.08	13	10	915.00
5645020	200	0.10	16	10	1280.00
5645021	250	0.12	16	10	1285.00
5645024	500	0.20	19	10	1690.00
5645029	1000	0.30	22	10	2455.00
5645030	2000	0.50	27	2	3990.00

- 5 ml to 20 ml supplied with trapezoidal shape for better stability
- For Stopper dimensions refer page no. 36
- * 20 ml not covered in standard



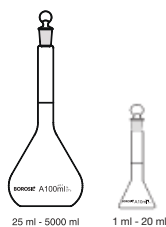

5645D - VOLUMETRIC FLASKS

Class A, USP, Narrow Mouth, Clear, with Individual Calibration Certificate, Neck size as per ISO (Long neck)

- Tolerance complies to USP / ASTM E288 standards and dimensions as per ISO 1042 standards **with ISI Mark**
- Supplied with Interchangeable Solid Glass Stopper
- Each flask is marked with individual serial number and supplied with certificate of calibration traceable to National standards
- Amber enamel inscriptions
- Calibrated & certified at 20°C

Product Code	Capacity ml	Tolerance ± ml	Stopper Size	Quantity Per Case	Price / Piece ₹
5645005D	5	0.02	10 / 19#	5	1220.00
5645006D	10	0.02	10 / 19#	5	1060.00
5645008D	20	0.03	10 / 19	5	1065.00
5645009D	25	0.03	10 / 19	5	980.00
5645012D	50	0.05	12 / 21	10	930.00
5645016D	100	0.08	14 / 23	10	915.00
5645020D	200	0.10	14 / 23	10	1280.00
5645021D	250	0.12	14 / 23	10	1285.00
5645024D	500	0.20	19 / 26	10	1690.00
5645029D	1000	0.30	24 / 29	10	2455.00
5645030D	2000	0.50	29 / 32	2	3990.00

- 5 ml to 20 ml supplied with trapezoidal shape for better stability
- # 5 ml & 10 ml stopper size Stopper size as per borosil scientific design

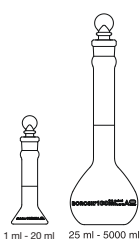

5647 - VOLUMETRIC FLASKS

ASTM, Wide Mouth, Clear, with Individual Calibration Certificate, Neck size as per ASTM (Bulgy neck)

- Complies fully with ASTM E 288 standards - For both dimensions as well as tolerance
- Supplied with Interchangeable Solid Glass Stopper
- Each flask is marked with individual serial number and supplied with certificate of calibration traceable to National standards
- Amber enamel inscriptions
- Specially designed wide mouth for testing bigger diameter tablets without making it in powder form
- Calibrated & certified at 20°C

Product Code	Capacity ml	Tolerance ± ml	Stopper Size	Quantity Per Case	Price / Piece ₹
5647005	5	0.08	13	5	1165.00
5647006	10	0.08	13	5	1005.00
5647008	20*	0.08	13	5	1040.00
5647009	25	0.08	13	5	1110.00
5647012	50	0.08	13	10	1085.00
5647016	100	0.10	16	10	1140.00
5647020	200	0.20	19	10	1340.00
5647021	250	0.20	19	10	1445.00
5647024	500*	0.30	22	10	1800.00
5647029	1000*	0.40	27	10	2610.00

- 5 ml to 20 ml supplied with trapezoidal shape for better stability
- For Stopper dimensions refer page no. 146
- * 20 ml, 500 ml & 1000 ml not covered in standard. OR
- * Not covered in standard.

5647D - VOLUMETRIC FLASKS

Class A, USP, Wide Mouth, Clear, with Individual Calibration Certificate, Neck size as per ISO (Long neck)

- Tolerance complies to ASTM E288 standards and dimensions as per ISO 1042 standards **with ISI Mark**
- Supplied with Interchangeable Solid Glass Stopper
- Each flask is marked with individual serial number and supplied with certificate of calibration traceable to National standards
- Amber enamel inscriptions
- Specially designed wide mouth for testing bigger diameter tablets without making it in powder form
- Calibrated & certified at 20°C

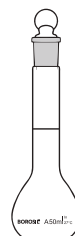

Product Code	Capacity ml	Tolerance ± ml	Stopper Size	Quantity Per Case	Price / Piece ₹
5647005D	5	0.08	12 / 21#	5	1165.00
5647006D	10	0.08	12 / 21#	5	1005.00
5647008D	20	0.08	12 / 21	5	1040.00
5647009D	25	0.08	12 / 21	5	1110.00
5647012D	50	0.08	14 / 23	10	1085.00
5647016D	100*	0.10	19 / 26	10	1140.00
5647020D	200*	0.20	19 / 26	10	1340.00
5647021D	250*	0.20	19 / 26	10	1445.00
5647024D	500*	0.30	24 / 29	10	1800.00
5647029D	1000	0.40	29 / 32	10	2610.00

- 5 ml to 20 ml supplied with trapezoidal shape for better stability
- # Stopper size as per Borosil Scientific Design
- * 100 ml, 200 ml, 250 ml & 500 ml not covered in standard. OR
- * Not covered in standard.

5648 - VOLUMETRIC FLASKS

Class A, Narrow Mouth, Amber, with Individual Calibration Certificate

- Complies with IS 815 / DIN - ISO 1042, Accuracy as per class A **with ISI Mark**
- Supplied with Interchangeable Solid Glass Stopper
- Each flask is marked with individual serial number and supplied with certificate of calibration traceable to National standards
- Amber coating on exterior surfaces to facilitate use with light sensitive solutions
- White enamel inscriptions
- Calibrated & certified at 27°C

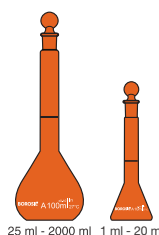

Product Code	Capacity ml	Tolerance ± ml	Stopper Size	Quantity Per Case	Price / Piece ₹
5648005	5	0.025	10 / 19#	5	1300.00
5648006	10	0.025	10 / 19#	5	1130.00
5648008	20	0.04	10 / 19	5	1130.00
5648009	25	0.04	10 / 19	5	1050.00
5648012	50	0.06	12 / 21	10	995.00
5648016	100	0.10	14 / 23	10	980.00
5648020	200	0.15	14 / 23	10	1360.00
5648021	250	0.15	14 / 23	10	1340.00
5648024	500	0.25	19 / 26	10	1795.00
5648029	1000	0.40	24 / 29	10	2615.00
5648030	2000	0.60	29 / 32	2	4250.00

- 5 ml to 20 ml supplied with trapezoidal shape for better stability
- # Stopper size as per Borosil Scientific Design

Volumetric Flasks

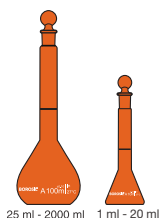

5649 - VOLUMETRIC FLASKS

Class B, Narrow Mouth, Amber

- Complies with IS 815 / DIN - ISO 1042, Accuracy as per class B with ISI Mark
- Supplied with interchangeable glass stopper
- Amber coating on exterior surfaces to facilitate use with light sensitive solutions
- White enamel inscriptions
- Calibrated at 27°C

Product Code	Capacity ml	Tolerance ± ml	Stopper Size	Quantity Per Case	Price / Piece ₹
5649005	5	0.05	10 / 19#	10	515.00
5649006	10	0.05	10 / 19#	10	490.00
5649008	20	0.08	10 / 19	10	490.00
5649009	25	0.08	10 / 19	10	490.00
5649012	50	0.12	12 / 21	10	515.00
5649016	100	0.20	14 / 23	10	585.00
5649020	200	0.30	14 / 23	10	615.00
5649021	250	0.30	14 / 23	10	625.00
5649024	500	0.50	19 / 26	10	940.00
5649029	1000	0.80	24 / 29	10	1540.00
5649030	2000	1.20	29 / 32	2	3140.00

- 5 ml to 20 ml supplied with trapezoidal shape for better stability
- Certified and Calibrated at 27°C
- # Stopper size as per Borosil Scientific Design



5650 - VOLUMETRIC FLASKS

For Sugar Estimation, Clear

- Complies with BS 675
- Supplied without stopper
- A two mark flask designed for the analysis of sugar solutions. The two graduation marks provide dilution of 1 in 10

Product Code	Capacity ml	Tolerance ± ml	Quantity Per Case	Price / Piece ₹
5650016	100 / 110	0.15	20	490.00

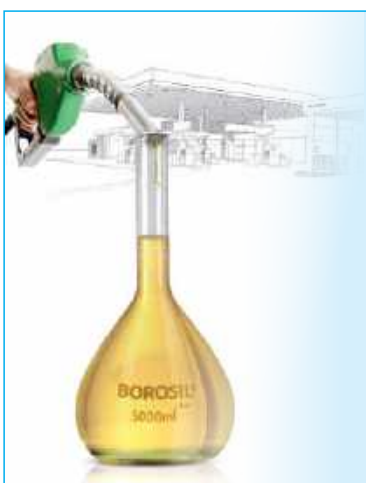

Certified Petroleum Measure for Retail Outlets

5639 - Jars, Measuring, with Pour Out, with Works Certificate

- Suitable for measurement of petrol and diesel
- Calibrated as per weight and measure guidelines



Product Code	Capacity ml	Quantity Per Case	Price / Piece ₹
5639033	5000	1	5865.00

5653 - VOLUMETRIC FLASKS

Class A, Wide Mouth, Amber, with Individual Calibration Certificate

- Complies with IS 815 / DIN - ISO 1042, Accuracy as per class A **with ISI Mark**
- Supplied with Interchangeable Solid Glass Stopper
- Each flask is marked with individual serial number and supplied with certificate of calibration traceable to National standards
- Amber coating on exterior surfaces to facilitate use with light sensitive solutions
- White enamel inscriptions
- Specially designed wide mouth for testing bigger diameter tablet without making it in powder form
- Calibrated & certified at 27°C



Product Code	Capacity ml	Tolerance ± ml	Stopper Size	Quantity Per Case	Price / Piece ₹
5653005	5	0.04	12 / 21#	5	1280.00
5653006	10	0.04	12 / 21#	5	1120.00
5653008	20	0.06	12 / 21	5	1140.00
5653009	25	0.06	12 / 21	5	1250.00
5653A09	25*	0.06	14 / 23	5	1250.00
5653012	50	0.10	14 / 23	10	1185.00
5653016	100*	0.10	19 / 26	10	1295.00
5653020	200*	0.15	19 / 26	10	1660.00
5653021	250*	0.15	19 / 26	10	2505.00
5653024	500*	0.25	24 / 29	10	2575.00
5653029	1000	0.60	29 / 32	10	2695.00

- * Not covered in the standards
- 5 ml to 20 ml supplied with trapezoidal shape for better stability
- # 5 ml & 10 ml (# Stopper size as per borosil scientific design)

5655 - VOLUMETRIC FLASKS

ASTM, Narrow Mouth, Amber, with Individual Calibration Certificate, Neck size as per ASTM (Bulgy neck)

- Complies fully with ASTM E 288 standards - For both dimensions as well as tolerance
- Supplied with Interchangeable Solid Glass Stopper
- Each flask is marked with individual serial number and supplied with certificate of calibration traceable to National standards
- Amber coating on exterior surfaces to facilitate use with light sensitive solutions
- White enamel inscriptions
- Calibrated & certified at 20°C

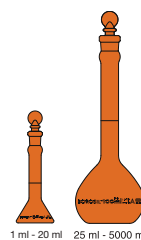

Product Code	Capacity ml	Tolerance ± ml	Stopper Size	Quantity Per Case	Price / Piece ₹
5655005	5	0.02	9	5	1455.00
5655006	10	0.02	9	5	1280.00
5655008	20*	0.03	9	5	1280.00
5655009	25	0.03	9	5	1175.00
5655012	50	0.05	9	10	1130.00
5655016	100	0.08	13	10	1100.00
5655020	200	0.10	16	10	1560.00
5655021	250	0.12	16	10	1565.00
5655024	500*	0.20	19	10	2060.00
5655029	1000*	0.30	22	10	3005.00
5655030	2000*	0.50	27	2	4840.00

- 5 ml to 20 ml supplied with trapezoidal shape for better stability
- For Stopper dimensions refer page no. 36
- * Not covered in standard

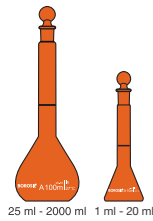

5655D - VOLUMETRIC FLASKS

Class A, USP, Narrow Mouth, Amber, with Individual Calibration Certificate, Neck size as per ISO (Long neck)

- Tolerance complies to ASTM E288 standards and dimensions as per ISO 1042 standards **with ISI Mark**
- Supplied with Interchangeable Solid Glass Stopper
- Each flask is marked with individual serial number and supplied with certificate of calibration traceable to National standards
- Amber coating on exterior surfaces to facilitate use with light sensitive solutions
- White enamel inscriptions
- Calibrated & certified at 20°C

Product Code	Capacity ml	Tolerance ± ml	Stopper Size	Quantity Per Case	Price / Piece ₹
5655005D	5	0.02	10 / 19#	5	1455.00
5655006D	10	0.02	10 / 19#	5	1280.00
5655008D	20*	0.03	10 / 19	5	1280.00
5655009D	25	0.03	10 / 19	5	1175.00
5655012D	50	0.05	12 / 21	10	1130.00
5655016D	100*	0.08	14 / 23	10	1100.00
5655020D	200*	0.10	14 / 23	10	1560.00
5655021D	250*	0.12	14 / 23	10	1565.00
5655024D	500*	0.20	19 / 26	10	2060.00
5655029D	1000	0.30	24 / 29	10	3005.00
5655030D	2000*	0.50	29 / 32	2	4840.00

- 5 ml to 20 ml supplied with trapezoidal shape for better stability
- # 5 ml & 10 ml stopper size not as per standards and kept wide mouth for convenient pipetting
- * Not covered in standard

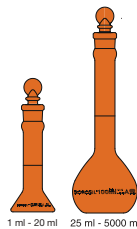

5657 - VOLUMETRIC FLASKS

ASTM, Wide Mouth, Amber, with Individual Calibration Certificate, Neck size as per ASTM (Bulgy neck)

- Complies fully with ASTM E 288 standards - For both dimensions as well as tolerance
- Supplied with Interchangeable Solid Glass Stopper
- Each flask is marked with individual serial number and supplied with certificate of calibration traceable to National standards
- Amber coating on exterior surfaces to facilitate use with light sensitive solutions
- White enamel inscriptions
- Specially designed wide mouth for testing bigger diameter tablets without making it in powder form
- Calibrated & certified at 20°C

Product Code	Capacity ml	Tolerance ± ml	Stopper Size	Quantity Per Case	Price / Piece ₹
5657005	5	0.08	13	5	1415.00
5657006	10	0.08	13	5	1220.00
5657008	20*	0.08	13	5	1220.00
5657009	25	0.08	13	5	1325.00
5657012	50	0.08	13	10	1300.00
5657016	100	0.10	16	10	1370.00
5657020	200	0.20	19	10	1610.00
5657021	250	0.20	19	10	1745.00

- 5 ml to 20 ml supplied with trapezoidal shape for better stability
- For Stopper dimensions refer page no. 36
- * Not covered in standard

5657D - VOLUMETRIC FLASKS

Class A, USP, Wide Mouth, Amber, with Individual Calibration Certificate, Neck size as per ISO (Long neck)

- Tolerance complies to ASTM E288 standards and dimensions as per ISO 1042 standards **with ISI Mark**
- Supplied with Interchangeable Solid Glass Stopper
- Each flask is marked with individual serial number and supplied with certificate of calibration traceable to National standards
- Amber coating on exterior surfaces to facilitate use with light sensitive solutions
- White enamel inscriptions
- Specially designed wide mouth for testing bigger diameter tablets without making it in powder form
- Calibrated & certified at 20°C

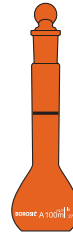

Product Code	Capacity ml	Tolerance ± ml	Stopper Size	Quantity Per Case	Price / Piece ₹
5657005D	5	0.08	12 / 21#	5	1415.00
5657006D	10	0.08	12 / 21#	5	1220.00
5657008D	20	0.08	12 / 21	5	1220.00
5657009D	25	0.08	12 / 21	5	1325.00
5657012D	50	0.08	14 / 23	10	1300.00
5657016D	100*	0.10	19 / 26	10	1370.00
5657020D	200*	0.20	19 / 26	10	1610.00
5657021D	250*	0.20	19 / 26	10	1745.00
5657024D	500*	0.30	24 / 29	10	2160.00
5657029D	1000	0.40	29 / 32	10	3150.00

- 5 ml to 20 ml supplied with trapezoidal shape for better stability
- # Stopper size as per Borosil Scientific Design
- * Not covered in standard

2020 - VOLUMETRIC FLASKS

NABL Certified, Class A, Clear, with Individual Calibration Certificate

- Complies with IS 815 DIN - ISO 1042, Accuracy as per class A **with ISI Mark**
- Supplied with Interchangeable Glass Stopper
- Each flask is marked with individual serial number and supplied with certificate of calibration traceable to National standards
- Amber enamel inscriptions
- Calibrated & certified at 27°C



Product Code	Capacity ml	Tolerance ± ml	New Stopper Size	New Quantity Per Case	Price / Piece ₹
2020001	1	0.025	7 / 16	1	2765.00
2020002	2	0.025	7 / 16	1	2765.00
2020005	5	0.025	10 / 19 #	1	2460.00
2020006	10	0.025	10 / 19 #	1	2130.00
2020008	20	0.04	10 / 19	1	2130.00
2020009	25	0.04	10 / 19	1	1980.00
2020012	50	0.06	12 / 21	1	1980.00
2020016	100	0.10	14 / 23	1	2040.00
2020020	200	0.15	14 / 23	1	2595.00
2020021	250	0.15	14 / 23	1	2635.00
2020024	500	0.25	19 / 26	1	3510.00
2020029	1000	0.40	24 / 29	1	5040.00
2020030	2000	0.60	29 / 32	1	8155.00

- 1 ml to 20 ml supplied with trapezoidal shape for better stability
- Certified and Calibrated at 27°C
- Volumetric flasks with old stopper sizes - Available till stocks last
- # Stopper size as per Borosil Scientific Design

Volumetric Flasks

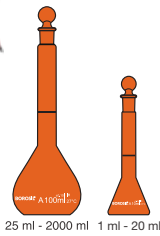

2021 - VOLUMETRIC FLASKS

NABL Certified, Class A, Amber, with Individual Calibration Certificate

- Complies with IS 815 / DIN - ISO 1042, Accuracy as per class A with ISI Mark
- Supplied with Interchangeable Glass Stopper
- Each flask is marked with individual serial number and supplied with certificate of calibration traceable to National standards
- White enamel inscriptions
- Calibrated & certified at 27°C

Product Code	Capacity ml	Tolerance ± ml	New Stopper Size	Quantity Per Case	Price / Piece ₹
2021005	5	0.025	10 / 19#	1	2670.00
2021006	10	0.025	10 / 19#	1	2330.00
2021008	20	0.04	10 / 19	1	2330.00
2021009	25	0.04	10 / 19	1	2110.00
2021012	50	0.06	12 / 21	1	2265.00
2021016	100	0.10	14 / 23	1	2345.00
2021020	200	0.15	14 / 23	1	2790.00
2021021	250	0.15	14 / 23	1	3100.00
2021024	500	0.25	19 / 26	1	3870.00
2021029	1000	0.40	24 / 29	1	5715.00
2021030	2000	0.60	29 / 32	1	8980.00

- 5 ml to 20 ml supplied with trapezoidal shape for better stability
 - # Stopper size as per Borosil Scientific Design



8100 - Glass Stoppers ISO / DIN, Penny head, Clear

Product Code	Stopper Number	Interchangeable Joint Size	Quantity Per Case	Price / Piece ₹
ISO / DIN Standard (Long Neck)				
8100A07	-	7 / 16	20	115.00
8100A10	-	10 / 19	20	120.00
8100A12	-	12 / 21	20	125.00
8100A14	-	14 / 23	20	125.00
8100A19	-	19 / 26	20	145.00
8100A24	-	24 / 29	20	285.00
8100A29	-	29 / 32	20	345.00
8100A34	-	34 / 35	20	360.00

8110 - Glass Stoppers ASTM, Penny head, Clear



Product Code	Stopper Number	Interchangeable Joint Size	Quantity Per Case	Price / Piece ₹
ASTM Standard (Short Neck)				
8110009	# 9	9.4 / 14	20	135.00
8110013	# 13	13.4 / 14	20	145.00
8110016	# 16	16.5 / 15	20	285.00
8110019	# 19	19.7 / 17	20	345.00
8110022	# 22	22.05 / 20.5	20	360.00
8110027	# 27	27.15 / 21.5	20	380.00

HSN Code : 70179090

8300 - Polypropylene (PP) Stoppers

- Flat head, ISO standard

Product Code	Interchangeable Joint Size	Quantity Per Case	Price / Piece ₹
8300A07	7 / 16	20	60.00
8300A10	10 / 19	20	65.00
8300A012	12 / 21	20	70.00
8300A14	14 / 23	20	75.00
8300A19	19 / 26	20	85.00
8300A24	24 / 29	20	105.00
8300A29	29 / 32	20	135.00
8300A34	34 / 35	20	150.00

HSN Code : 39235010



8400 - Glass Stoppers

ISO / DIN, Penny head, Amber

Product Code	Stopper Number	Interchangeable Joint Size	Quantity Per Case	Price / Piece ₹
ISO / DIN Standard (Long Neck)				
8400A07	–	7 / 16	20	120.00
8400A10	–	10 / 19	20	145.00
8400A12	–	12 / 21	20	195.00
8400A14	–	14 / 23	20	195.00
8400A19	–	19 / 26	20	220.00
8400A24	–	24 / 29	20	340.00
8400A29	–	29 / 32	20	400.00
8400A34	–	34 / 35	20	435.00



Stoppers

8410 - Glass Stoppers

ASTM, Penny head, Amber

Product Code	Stopper Number	Interchangeable Joint Size	Quantity Per Case	Price / Piece ₹
ASTM Standard				
8410009	# 9	9.4 / 14	20	160.00
8410013	# 13	13.4 / 14	20	190.00
8410016	# 16	16.5 / 15	20	340.00
8410019	# 19	19.7 / 17	20	420.00
8410022	# 22	22.05 / 20.5	20	440.00
8410027	# 27	27.15 / 21.5	20	455.00





8500 - Glass Stoppers

ISO / DIN, Flat Head, Clear

Product Code	Interchangeable Joint Size	Quantity Per Case	Price / Piece ₹
ISO / DIN Standard (Long Neck)			
8500A10	10/19	20	140.00
8500A12	12/21	20	165.00
8500A14	14/23	20	165.00
8500A19	19/26	20	195.00
8500A24	24/29	20	340.00
8500A29	29/32	20	415.00



8700 - Glass Stoppers

ISO / DIN, Flat Head, Amber

Product Code	Interchangeable Joint Size	Quantity Per Case	Price / Piece ₹
ISO / DIN Standard (Long Neck)			
8700A10	10/19	20	195.00
8700A12	12/21	20	250.00
8700A14	14/23	20	265.00
8700A19	19/26	20	300.00
8700A24	24/29	20	430.00
8700A29	29/32	20	480.00

6100 - CHROMATOGRAPHY COLUMNS

Plain With Glass Stopcock

- Designed with straight bore stopcock that increases the life as compared to PTFE key stopcocks
- The glass stopcock enhances control and facilities smoother action
- Generally used for purification of individual compounds from mixtures of compounds



Product Code	Length mm	Bore Dia mm	Quantity Per Case	Price / Piece ₹
6100060	200	10	5	535.00
6100061	300	10	5	580.00
6100062	300	18	5	630.00
6100063	450	30	5	795.00
6100064	500	10	5	625.00
6100065	500	18	5	655.00
6100066	600	30	5	1050.00
6100067	600	40	5	1365.00
6100068	1000	40	4	2795.00

Note : The Columns with Boroflow & PTFE stopcock will be made available on request

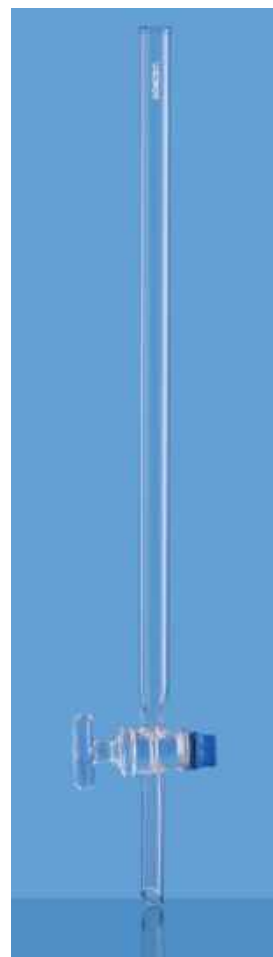

6101 - CHROMATOGRAPHY COLUMNS

With Sintered Disc & Glass Stopcock

- Designed with straight bore stopcock that increases the life as compared to PTFE key stopcocks
- The glass stopcock enhances control and facilities smoother action
- Columns are added with a Sintered Disc for good results
- Generally used for purification of individual compounds from mixtures of compounds
- Columns are added with a Sintered Disc (Grade I) for good result



Product Code	Length mm	Bore Dia mm	Quantity Per Case	Price / Piece ₹
6101060	200	10	5	885.00
6101061	300	10	5	910.00
6101062	300	18	5	1130.00
6101063	450	30	5	1400.00
6101064	500	10	5	1050.00
6101065	500	18	5	1230.00
6101066	600	30	5	1450.00
6101067	600	40	5	2400.00
6101068	1000	40	4	3260.00

Note : The Columns with Boroflow & PTFE stopcock will be made available on request

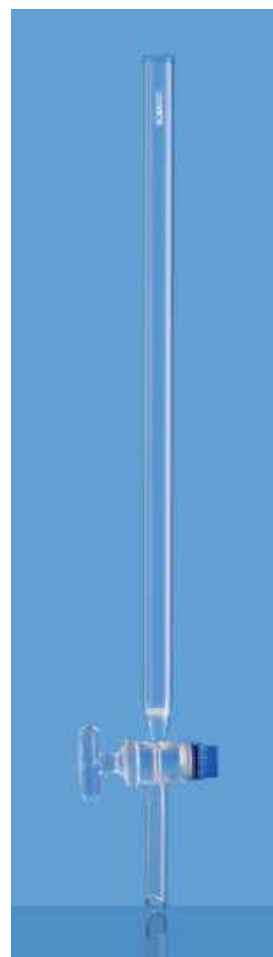

Funnels

Funnels may be used for separating solids from liquids, liquids from liquids and occasionally, for pouring something into a container.

BOROSIL® brand Funnels are available in a comprehensive range for a variety of such applications. Sintered Glass Funnels are also available.

Separating Funnels come in globe, pear and cylindrical shapes with ground glass stopcocks and interchangeable stoppers. These Funnels are made of specially moulded blanks. Stopcock bores, body openings and stems are carefully aligned to facilitate the smooth and even flow of liquid with fast cut-off.

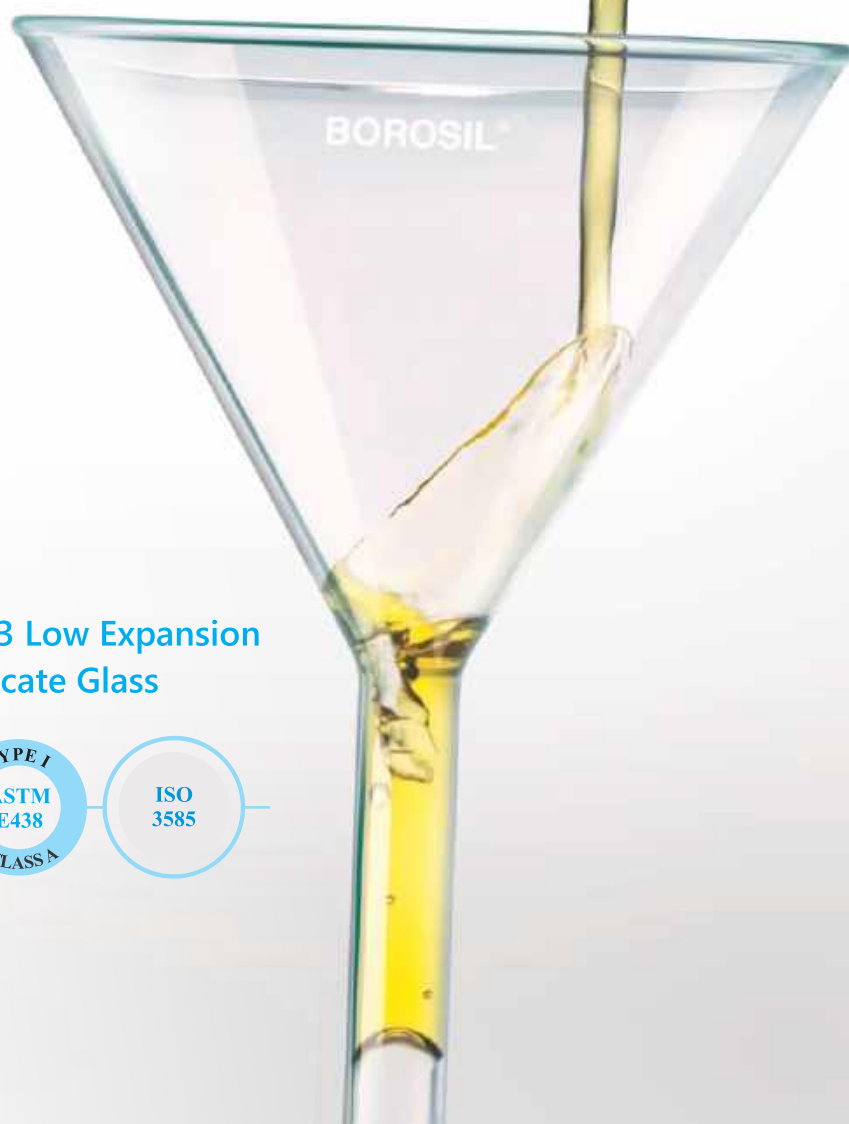

Made from 3.3 Low Expansion
Borosilicate Glass



Please contact CT Enterprises for quotation.

Email: sales@ctenterprises.in | Phone: +91 8977721310

6140 - GLASS FILTER FUNNEL

Short Stem

- Complies with IS 1591, DIN / ISO 4798
- Designed with a 60° bowl angle to ensure precise fitting of the filter paper
- High thermal shock resistance and chemical resistance
- Generally used for filtering and decanting liquids of varied densities

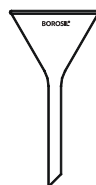

Product Code	Diameter mm	Stem		Quantity Per Case	Price / Piece ₹
		OD	Length		
6140057	25*	6	25	30	120.00
6140058	35	6	35	30	150.00
6140065	50*	8	50	20	160.00
6140069	65*	8	65	20	195.00
6140071	75	8	75	20	185.00
6140077	100	10	100	40	245.00

- * Not covered in standard

6150 - FUNNEL TEST TUBES

- Specially designed for soil testing laboratory



Product Code	Capacity ml	Quantity Per Case	Price / Piece ₹
6150007	15	10	245.00
6150010	30	10	305.00

6220 - POWDER FUNNEL

With Stem

- Designed with a short wide stem to facilitate smooth flow
- Ideal for transferring powders

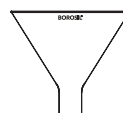

Product Code	Capacity ml	Quantity Per Case	Price / Piece ₹
6220080	125	30	545.00
6220081	150	20	580.00
6220087	200	4	1640.00
6220089	250	4	2245.00

6230 - POWDER FUNNEL

Stem With Cone

- Supplied with ground glass cone for easy fitting on flask
- Interchangeable joint size 24/29
- Designed with a short wide stem to facilitate smooth flow
- Ideal for transferring powders

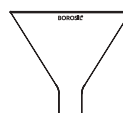

Product Code	Capacity ml	Quantity Per Case	Price / Piece ₹
6230080	125	20	815.00
6230081	150	20	940.00
6230087	200	4	1810.00
6230089	250	4	2725.00



6340 - SEPARATING FUNNEL, GLOBE SHAPE

With Glass Stopcock & I/C Glass Stopper

- Designed with globe shape and with a stem
- Generally used in the separation phase

Product Code	Capacity ml	Stopper Size	Quantity Per Case	Price / Piece ₹
6340017	125	19 / 26	10	1565.00
6340021	250	24 / 29	10	1715.00
6340024	500	24 / 29	10	2160.00
6340029	1000	29 / 32	5	2725.00
6340030	2000	29 / 32	10	4600.00
6340033	5000	34 / 35	1	10430.00

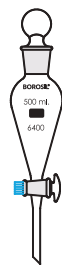

6400 - SEPARATING FUNNEL, PEAR SHAPE

With Glass Stopcock & I/C Glass Stopper

- Complies with IS 1575, DIN / ISO 4800
- Designed with pear shape and with a stem
- Generally used in the separation phase

Product Code	Capacity ml	Stopper Size	Quantity Per Case	Price / Piece ₹
6400013	60*	14 / 23	10	1335.00
6400017	125*	19 / 26	10	1450.00
6400021	250	24 / 29	10	1530.00
6400024	500	24 / 29	10	2110.00
6400029	1000	29 / 32	10	2760.00
6400030	2000	29 / 32	10	5025.00

* Not covered in standards.

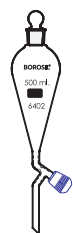

6402 - SEPARATING FUNNEL, PEAR SHAPE

With Boroflo Stopcock And I/C Glass Stopper

- Complies with IS 1575, DIN / ISO 4800
- Designed with pear shape and with a stem
- Generally used in the separation phase

Product Code	Capacity ml	Stopper Size	Quantity Per Case	Price / Piece ₹
6402013	60*	14 / 23	10	1190.00
6402017	125*	19 / 26	10	1290.00
6402021	250	24 / 29	10	1430.00
6402024	500	24 / 29	10	1920.00
6402029	1000	29 / 32	10	2525.00
6402030	2000	29 / 32	10	4435.00

* Not covered in standards.

6403 - SEPARATING FUNNEL, PEAR SHAPE, With PTFE Stopcock And I/C Glass Stopper

- Complies with IS 1575, DIN / ISO 4800
- Designed with pear shape and with a stem
- Generally used in the separation phase



Product Code	Capacity ml	Stopper Size	Quantity Per Case	Price / Piece ₹
6403017	125*	19 / 26	10	1685.00
6403021	250	24 / 29	10	1845.00
6403024	500	24 / 29	10	2400.00
6403029	1000	29 / 32	10	2860.00
6403030	2000	29 / 32	10	5320.00

* Not covered in standards.



6405 - PRESSURE EQUILISING CYLINDRICAL FUNNEL

With PTFE Stopcock

- Supplied with polypropylene stopper
- Equipped with totally grease free and self lubricating PTFE stopcock



Product Code	Capacity ml	Socket	Cone	Quantity Per Case	Price / Piece ₹
6405012	50	19 / 26	19 / 26	5	1610.00
6405016	100	19 / 26	19 / 26	5	1935.00
6405021	250	24 / 29	24 / 29	5	2210.00
6405024	500	24 / 29	24 / 29	5	3430.00



Funnels

6408 - DROPPING FUNNEL, Graduated With Glass Stopcock

- Complies with IS 1575, DIN / ISO 4800
- Supplied with glass stopcock

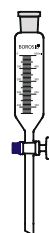

Product Code	Capacity ml	Stopper Size	Quantity Per Case	Price / Piece ₹
6408012	50	14 / 23	5	1020.00
6408016	100	19 / 26	5	1110.00
6408021	250	24 / 29	5	1280.00
6408024	500	24 / 29	5	1715.00
6408029	1000	29 / 32	5	2845.00

* Not covered in standards.





6560 - PLAIN SHANK SINGLE CONE

- Complies to DIN 12249
- Joints are made with precision grinding

Product Code	Cone Joint Size	Total Length	Quantity Per Case	Price / Piece ₹
6560010	10 / 19	120	5	195.00
6560012	12 / 21	120	5	205.00
6560014	14 / 23	120	5	225.00
6560019	19 / 26	125	5	270.00
6560024	24 / 29	135	5	325.00
6560029	29 / 32	135	5	415.00
6560034	34 / 35	150	5	580.00
6560040	40 / 38*	150	5	660.00
6560045	45 / 40*	150	5	790.00
6560050	50 / 42*	150	5	910.00
6560055	55 / 44	150	5	1075.00

* Not covered in standard



6561- PLAIN SHANK DOUBLE CONE

- Complies to DIN 12249
- Joints are made with precision grinding

Product Code	Cone Joint Size	Total Length	Quantity Per Case	Price / Piece ₹
6561010	10 / 19	125	5	360.00
6561012	12 / 21	135	5	420.00
6561014	14 / 23	135	5	515.00
6561019	19 / 26	140	5	580.00
6561024	24 / 29	170	5	695.00
6561029	29 / 32	170	5	955.00
6561034	34 / 35	180	5	1120.00
6561040	40 / 38	185	5	1335.00

6580 - PLAIN SHANK SINGLE SOCKET

- Complies to DIN 12249
- Joints are made with precision grinding



Product Code	Cone Joint Size	Total Length	Quantity Per Case	Price / Piece ₹
6580010	10 / 19	120	5	205.00
6580012	12 / 21	120	5	235.00
6580014	14 / 23	120	5	265.00
6580019	19 / 26	125	5	270.00
6580024	24 / 29	135	5	335.00
6580029	29 / 32	135	5	415.00
6580034	34 / 35	150	5	580.00
6580040	40 / 38	150	5	705.00
6580045	45 / 40	150	5	910.00
6580050	50 / 42	150	5	1035.00
6580055	55 / 44	150	5	1285.00



6581 - PLAIN SHANK DOUBLE SOCKET

- Complies to DIN 12249
- Joints are made with precision grinding



Product Code	Cone Joint Size	Total Length	Quantity Per Case	Price / Piece ₹
6581010	10 / 19	125	5	335.00
6581012	12 / 21	135	5	400.00
6581014	14 / 23	135	5	460.00
6581019	19 / 26	140	5	515.00
6581024	24 / 29	170	5	580.00
6581029	29 / 32	170	5	695.00
6581034	34 / 35	180	5	955.00
6581040	40 / 38	185	5	1035.00



Cones

Gas Generator

6550 - GAS GENERATOR APPARATUS (KIPPS)

- Used to produce common gases
- Simple to operate and assemble
- Quick charging

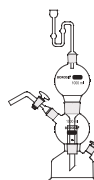

Product Code	Capacity ml	Quantity Per Case	Price / Piece ₹
6550024	500	1	12835.00
6550029	1000	1	16400.00



Museum Jar

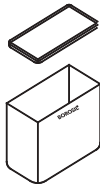

6910 - RECTANGULAR MUSEUM JAR With Lid

- Jar made of 3.3 low expansion borosilicate glass and lid made from sodalime glass
- Specially blown to give sturdiness and long life
- Top edges are flat ground
- Not recommended for use over a direct flame or on a hot plate
- For storage and display of preserved organs and organisms in Museums, Hospitals and Medical Colleges

Product Code	Approx Height × Length × Breadth mm	Quantity Per Case	Price / Piece ₹
6910M41	200 × 125 × 125	1	11230.00
6910M42	200 × 150 × 100	1	11890.00
6910M43	220 × 195 × 80	1	13230.00
6910M44	250 × 165 × 140	1	13850.00
6910M45	250 × 250 × 120	1	16665.00
6910M46	360 × 150 × 100	1	27925.00



6912 - CYLINDRICAL MUSEUM JAR With Lid

- Jar made of 3.3 low expansion borosilicate glass and lid made from sodalime glass
- Specially blown to give sturdiness and long life
- Not recommended for use over a direct flame or on a hot plate
- For storage and display of preserved organs and organisms in Museums, Hospitals and Medical Colleges

Product Code	Appro × OD × Height mm	Quantity Per Case	Price / Piece ₹
6912M61	100 × 150	2	5555.00
6912M62	115 × 200	2	7050.00
6912M63	130 × 300	2	9565.00
6912M64	150 × 300	2	12700.00
6912M65	230 × 300	2	22555.00
6912M66	300 × 450	1	35785.00
6912M67	315 × 600	1	36635.00
6912M68	325 × 750	1	45220.00
6912M69	325 × 900	1	45730.00
6912M70	150 × 380	1	14620.00
6912M71	115 × 260	1	11135.00
6912M72	230 × 380	1	19295.00
6912M73	415 × 1000	1	388535.00
6912M74	415 × 1200	1	388535.00

6947 - REACTION KETTLES ASSEMBLY

Resin Reaction

- The wide mouth enables easy access for cleaning the interior
- Flanges of the covers and base are finely ground to ensure a tight seal
- Equipped with interchangeable covers with four openings
- Designed for viscous reaction materials

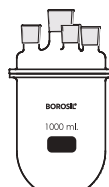

Product Code	Capacity ml	Body Dia mm	Height mm	Quantity Per Case Set	Price / Piece ₹
6947024	500	100	150	1	16515.00
6947029	1000	110	175	1	17220.00
6947030	2000	150	185	1	20990.00
6947032	4000	150	340	1	25235.00

The 500 ml and 1000 ml kettles have interchangeable covers with four openings to accommodate 24 / 29 interchangeable joints. Kettles of 2000 ml and 4000 ml capacity have interchangeable covers with openings to accommodate three 24 / 29 interchangeable joints and one 34 / 35 interchangeable joint.

6948 - BOTTOM FOR KETTLE REACTION ASSEMBLY

Only for Kettles Cat no. 6947

The base has a wide mouth that enables easy access for cleaning the interior
Flanges of the base are finely ground to ensure a tight seal



Product Code	Capacity ml	Quantity Per Case	Price / Piece ₹
6948024	500	2	7975.00
6948029	1000	2	8860.00
6948030	2000	2	11505.00
6948032	4000	2	16815.00

Kettles

6949 - COVER FOR KETTLE REACTION ASSEMBLY

Only for Kettles Cat No. 6947

- The covers have openings with interchangeable joints to facilitate rapid assembly with Condensers and Stirrers
- Flanges of the covers are finely ground to ensure a tight seal

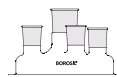

Product Code	Capacity ml	Quantity Per Case	Price / Piece ₹
6949041	500 / 1000	2	12695.00
6949042	2000 / 4000	2	14740.00

The 500 ml and 1000 ml kettles have interchangeable covers with four openings to accommodate 24 / 29 interchangeable joints. Kettles of 2000 ml and 4000 ml capacity have interchangeable covers with openings to accommodate three 24 / 29 interchangeable joints and one 34 / 35 interchangeable joint.

Pipettes

BOROSIL® Pipettes are made from heavy walled, machine drawn borosilicate glass tubing, of precise bore sizes, to provide highest level of accuracy. The mouthpiece of pipettes, of capacities >5ml are tooled with uniform OD for easy aspiration of liquids. Tooling imparts additional strength to the pipettes.

- Individually calibrated by automatic calibration process
- Available in both Class A and Class B tolerances
- Individual calibration certificate provided for Class A pipettes
- Graduation markings made using finest quality white enamel or amber ink to ensure maximum durability
- Color coded in accordance with ISO standards to facilitate easy identification
- Chip resistant bevelled ground edges
- Pipettes can be autoclaved or flame sterilized as per requirement

Made from 3.3 Low Expansion Borosilicate Glass



Please contact CT Enterprises for quotation.

Email: sales@ctenterprises.in | Phone: +91 8977721310

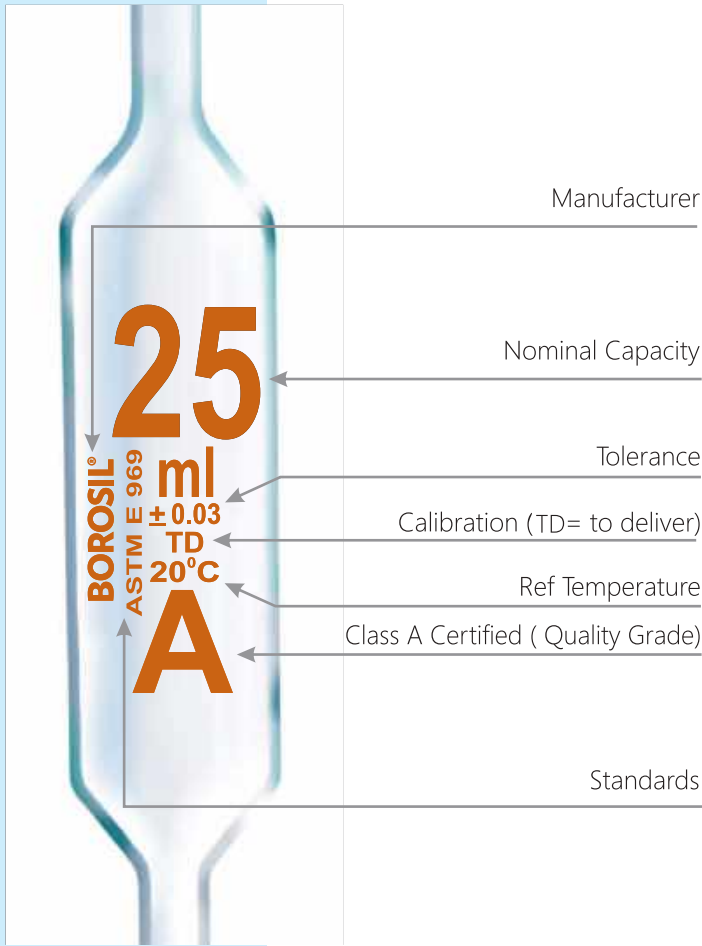

Mohr Type
 Delivery from zero mark to the last graduation mark



Serological Type
 Delivery from zero mark to the tip

Two Rings

Two rings at the top indicate that pipettes are calibrated to deliver their total capacity



Tips are carefully tooled to ensure proper flow rates
 Tip edges are fire polished

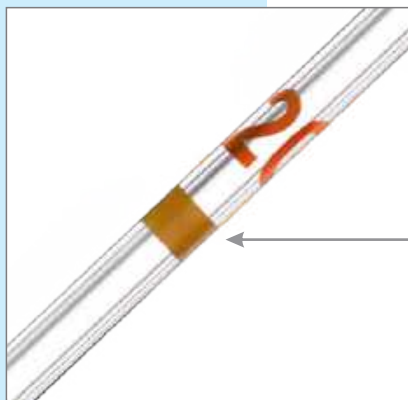

All pipettes are colour coded for quick identification

- Pipettes
- Weighing Scoop
- Mortar and Pestle
- Tubes

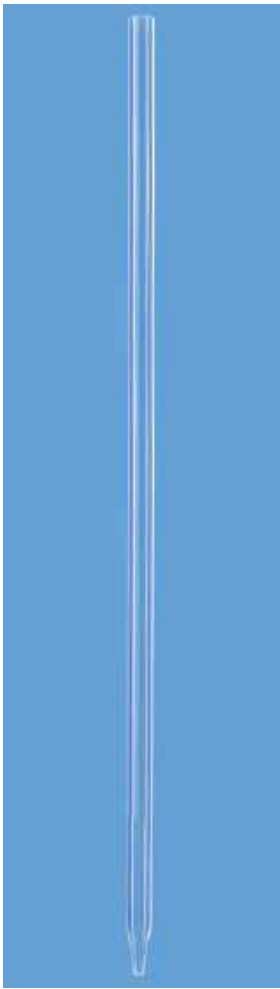

7040 - ARTIFICIAL INSEMINATION PIPETTES

- Sturdy, strong and safe for repeated use
- It can be sterilised and cleaned easily
- Tapered tip for efficient use
- Ideal for artificial insemination in cattles

Product Code	Length mm	Quantity Per Case	Price / Piece ₹
7040162	450	60	135.00

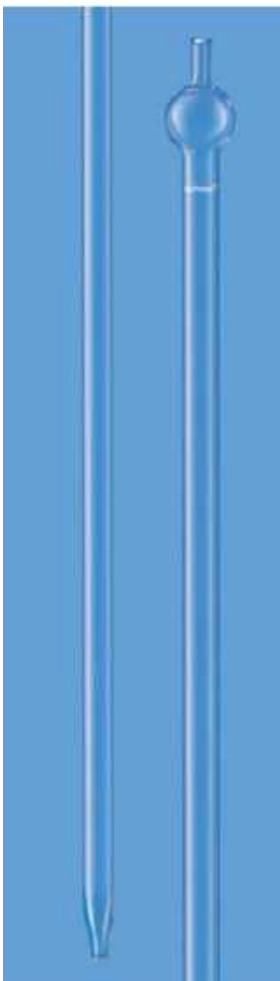

7041 - DRUM SAMPLING PIPETTE

Product Code	Length mm	Quantity Per Case	Price / Piece ₹
7041041	1000	4	600.00

7056 - MILK/BACTERIOLOGICAL PIPETTES

- Complies with IS 2025
- Available in two capacities - 1.1ml and 2.2 ml
- 1.1 ml is graduated at 0.5 to 1.1 ml
- 2.2 ml is graduated at 1.0, 2.0, 2.1 and 2.2 ml
- Used for the bacteriological examination of milk in dairy industries



Product Code	Capacity ml	Tolerance \pm ml	Quantity Per Case	Price / Piece ₹
7056101	1.1	0.025	10	245.00
7056102	2.2	0.040	10	270.00

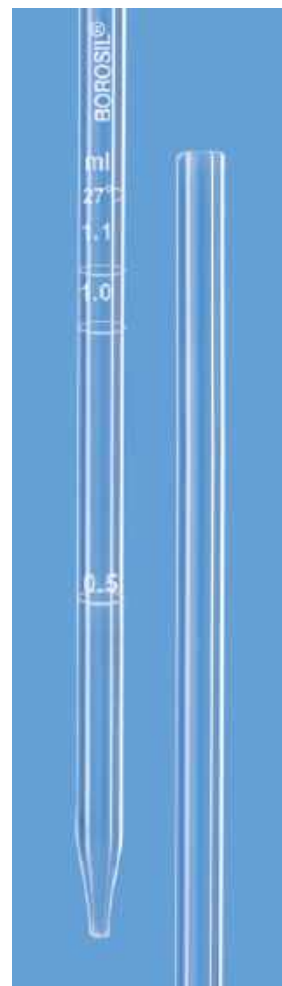

7057 - GERBER MILK PIPETTES

- Complies with IS 1223 (Part II)
- Sturdy, designed to last long
- Used for testing milk by the Gerber method
- Gerber Milk Pipettes are one-mark transfer Pipettes for measuring 10.75 ml
- They can be also be used in rural Milk Collection Centres



Product Code	Capacity ml	Tolerance \pm ml	Quantity Per Case	Price / Piece ₹
7057P10	10.75	0.03	10	265.00



Pipettes

7058 - GERBER MILK PIPETTES with Certificate

- Provided with calibration certificate

Product Code	Capacity ml	Tolerance \pm ml	Quantity Per Case	Price / Piece ₹
7058P10	10.75	0.015	10	540.00

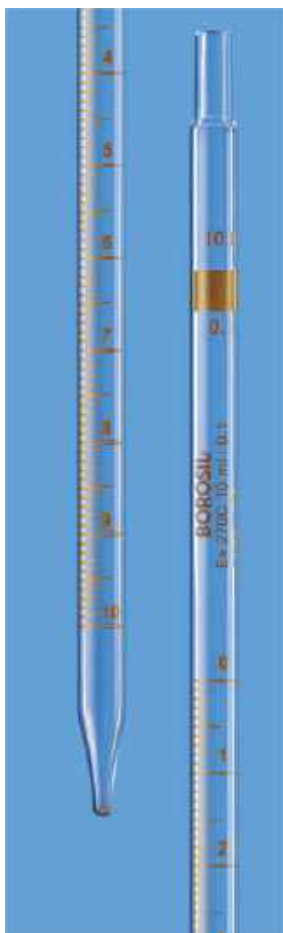

7059 - MOHR PIPETTES

Class A, with Individual Calibration Certificate

- Complies with IS, ISO 835, Type I
- Graduated for delivery from zero mark to the last graduation mark
- Supplied with individual calibration certificate showing actual volume dispensed and providing traceability to national standards
- Markings are made in permanent amber stain diffused into the surface of the glass for better visibility and durability
- Calibrated and certified at 27°C

Product Code	Capacity ml	Graduation Interval ml	Tolerance +/- ml	Quantity per Case	Price / Piece ₹
7059P41	0.1	0.01	0.006	10	675.00
7059P42	0.2	0.01	0.006	10	675.00
7059P01	1	0.01	0.007	10	635.00
7059P11	1	0.10	0.007	10	560.00
7059P02	2	0.02	0.01	10	625.00
7059P22	2	0.10	0.01	10	580.00
7059P05	5	0.05	0.03	10	725.00
7059P55	5	0.10	0.03	10	675.00
7059P06	10	0.10	0.05	10	775.00
7059P09	25	0.20	0.10	10	915.00



7060 - MOHR PIPETTES

Class B

- Complies with IS, ISO 835, Type I
- Graduated for delivery from zero mark to the last graduation mark
- Markings are made in permanent amber stain diffused into the surface of the glass for better visibility and durability
- Calibrated at 27°C

Product Code	Capacity ml	Graduation Interval ml	Tolerance +/- ml	Quantity Per Case	Price / Piece ₹
7060P41	0.1	0.01	0.01	20	225.00
7060P42	0.2	0.01	0.01	20	215.00
7060P01	1	0.01	0.01	20	215.00
7060P11	1	0.10	0.01	20	200.00
7060P02	2	0.02	0.02	20	225.00
7060P22	2	0.10	0.02	20	215.00
7060P05	5	0.05	0.05	20	240.00
7060P55	5	0.10	0.05	20	225.00
7060P06	10	0.10	0.10	20	265.00
7060P09	25	0.20	0.20	20	410.00

7062 - MOHR PIPETTES

Class B, White Marking

- Complies with ISO 835
- Graduated for delivery from zero mark to the last graduation mark
- Graduation in white enamel for increased visibility against dark solutions
- Calibrated at 27°C



Product Code	Capacity ml	Graduation Interval ml	Tolerance ± ml	Quantity Per Case	Price / Piece ₹
7062P41	0.1	0.01	0.01	20	225.00
7062P42	0.2	0.01	0.01	20	215.00
7062P01	1	0.01	0.01	20	215.00
7062P11	1	0.10	0.01	20	200.00
7062P02	2	0.02	0.02	20	225.00
7062P22	2	0.10	0.02	20	215.00
7062P05	5	0.05	0.05	20	240.00
7062P55	5	0.10	0.05	20	225.00
7062P06	10	0.10	0.10	20	265.00
7062P09	25	0.20	0.20	20	410.00



7079 - SEROLOGICAL PIPETTES

Class A, With Individual Calibration Certificate

- Complies with IS, ISO 835, Type III total delivery
- These Pipettes are graduated to the tip
- Two rings at the top indicate that the Pipette is calibrated to deliver from any graduation line down to tip
- Supplied with individual calibration certificate showing actual volume dispensed and providing traceability to national standards
- Markings are made in permanent amber stain diffused into the surface of the glass for better visibility and durability
- Calibrated and certified at 27°C



Product Code	Capacity ml	Graduation Interval ml	Tolerance ± ml	Quantity Per Case	Price / Piece ₹
7079P41	0.1	0.01	0.006	10	675.00
7079P42	0.2	0.01	0.006	10	675.00
7079P01	1	0.01	0.007	10	635.00
7079P11	1	0.10	0.007	10	560.00
7079P02	2	0.02	0.01	10	625.00
7079P22	2	0.10	0.01	10	580.00
7079P05	5	0.05	0.03	10	725.00
7079P55	5	0.10	0.03	10	675.00
7079P06	10	0.10	0.05	10	775.00
7079P09	25	0.20	0.10	10	915.00

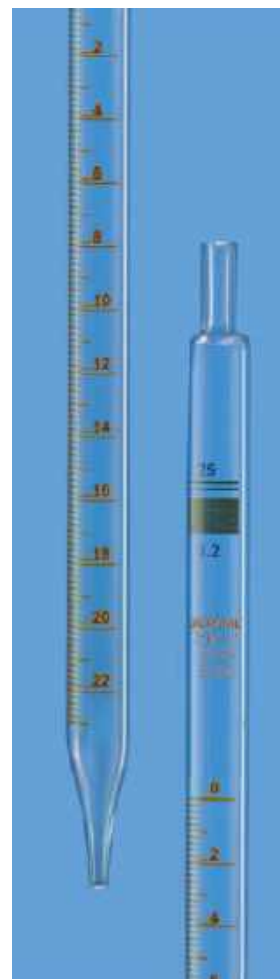

Pipettes

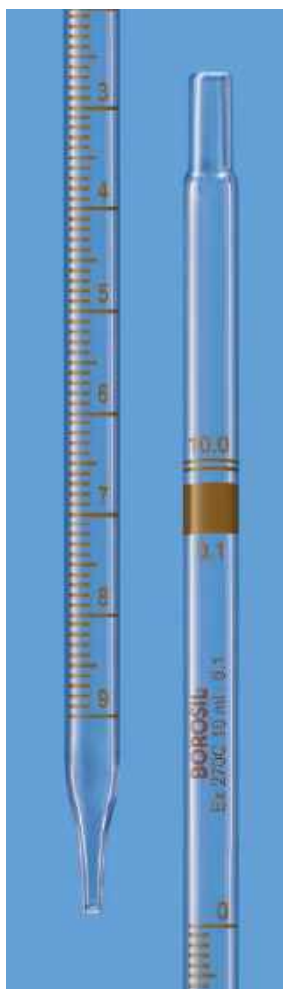

7080 - SEROLOGICAL PIPETTES

Class B

- Complies with IS, ISO 835
- These Pipettes are graduated to the tip
- Two rings at the top indicate that the Pipette is calibrated to deliver from any graduation line down to tip
- Markings are made in permanent amber stain diffused into the surface of the glass for better visibility and durability
- Calibrated at 27°C

Product Code	Capacity ml	Graduation Interval ml	Tolerance \pm ml	Quantity Per Case	Price / Piece ₹
7080P41	0.1	0.01	0.01	20	225.00
7080P42	0.2	0.01	0.01	20	215.00
7080P01	1	0.01	0.01	20	215.00
7080P11	1	0.10	0.01	20	200.00
7080P02	2	0.02	0.02	20	225.00
7080P22	2	0.10	0.02	20	215.00
7080P05	5	0.05	0.05	20	240.00
7080P55	5	0.10	0.05	20	225.00
7080P06	10	0.10	0.10	20	265.00
7080P09	25	0.20	0.20	20	410.00

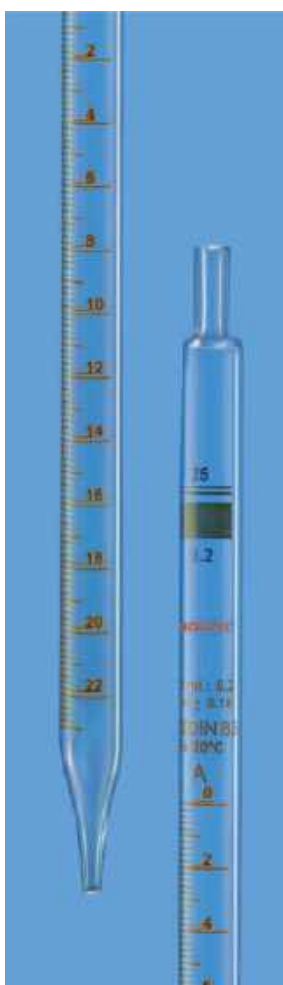

7081 - SEROLOGICAL PIPETTES

Class A, USP, With Individual Calibration Certificate

- Complies with ASTM 1293 - 02
- These pipettes are graduated to the tip
- Two rings at the top indicate that the pipette is calibrated to deliver from any graduation line down to tip
- Supplied with individual calibration certificate showing actual volume dispensed and providing traceability to national standards
- Markings are made in permanent amber stain diffused into the surface of the glass for better visibility and durability
- Calibrated and certified at 20°C

Product Code	Capacity ml	Graduation Interval ml	Tolerance \pm ml	Quantity Per Case	Price / Piece ₹
7081P01	1	0.01	0.01	10	610.00
7081P11	1	0.10	0.01	10	570.00
7081P22	2	0.10	0.01	10	610.00
7081P55	5	0.10	0.02	10	730.00
7081P06	10	0.10	0.03	10	790.00
7081P09	25	0.10	0.05	10	930.00

7082 - SEROLOGICAL PIPETTES

Class B, White marking

- Complies with IS, ISO 835
- These Pipettes are graduated to the tip
- Two rings at the top indicate that the Pipette is calibrated to deliver from any graduation line down to tip
- Graduation in white enamel for increased visibility against dark solutions
- Calibrated at 27°C



Product Code	Capacity ml	Graduation Interval ml	Tolerance \pm ml	Quantity Per Case	Price / Piece ₹
7082P41	0.1	0.01	0.01	20	225.00
7082P42	0.2	0.01	0.01	20	215.00
7082P01	1	0.01	0.01	20	215.00
7082P11	1	0.10	0.01	20	200.00
7082P02	2	0.02	0.02	20	225.00
7082P22	2	0.10	0.02	20	215.00
7082P05	5	0.05	0.05	20	240.00
7082P55	5	0.10	0.05	20	225.00
7082P06	10	0.10	0.10	20	265.00
7082P09	25	0.20	0.20	20	410.00

7100 - VOLUMETRIC PIPETTES

Class A, with Individual Calibration Certificate

- Complies with IS 1117 / ISO 648 **with ISI Mark**
- Calibrated for delivery (TD, Ex)
- Each pipette coded with unique identification number (UID) and supplied with calibration certificate with traceability to national standards
- Generally used for accurate measurement and decanting of liquid
- Calibrated and certified at 27°C



Pipettes

Product Code	Capacity ml	Tolerance \pm ml	Quantity Per Case	Price / Piece ₹
7100001	1	0.008	10	425.00
7100002	2	0.01	10	430.00
7100005	5	0.015	10	485.00
7100006	10	0.02	10	580.00
7100008	20	0.03	10	760.00
7100009	25	0.03	10	805.00
7100012	50	0.05	10	915.00
7100016	100	0.08	10	1385.00



7101 - VOLUMETRIC PIPETTES

Class A, ASTM with Individual Calibration Certificate

- Complies with ASTM E-969-02
- Calibrated for delivery (TD, Ex)
- Each pipette coded with unique identification number (UID) and supplied with calibration certificate with traceability to national standards
- Generally used for accurate measurement and decanting of liquid
- Calibrated and certified at 20°C

Product Code	Capacity ml	Tolerance \pm ml	Quantity Per Case	Price / Piece ₹
7101001	1	0.006	10	445.00
7101105	1.5*	0.006	10	500.00
7101002	2	0.006	10	500.00
7101205	2.5*	0.006	10	560.00
7101003	3	0.01	10	525.00
7101004	4	0.01	10	525.00
7101005	5	0.01	10	530.00
7101706	6	0.01	10	580.00
7101707	7	0.01	10	580.00
7101708	8	0.02	10	580.00
7101709	9	0.02	10	580.00
7101006	10	0.02	10	605.00
7101007	15	0.03	10	680.00
7101008	20	0.03	10	790.00
7101009	25	0.03	10	830.00
7101010	30	0.03	10	830.00
7101011	40	0.05	10	885.00
7101012	50	0.05	10	960.00
7101016	100	0.08	10	1445.00

* As per Borosil Scientific standard



7102 - VOLUMETRIC PIPETTES

Class B

- Complies with IS 1117 / ISO 648 **with ISI Mark**
- Calibrated for delivery (TD, Ex)
- Generally used for accurate measurement and decanting of liquid
- Calibrated at 27°C

Product Code	Capacity ml	Tolerance \pm ml	Quantity Per Case	Price / Piece ₹
7102001	1	0.015	10	215.00
7102002	2	0.02	10	225.00
7102003	3*	0.02	10	225.00
7102004	4*	0.02	10	225.00
7102005	5	0.03	10	240.00
7102706	6*	0.03	10	255.00
7102707	7*	0.03	10	255.00
7102708	8*	0.04	10	255.00
7102709	9*	0.04	10	255.00
7102006	10	0.04	10	280.00
7102007	15*	0.06	10	315.00
7102008	20	0.06	10	320.00
7102009	25	0.06	10	335.00
7102010	30*	0.06	10	325.00
7102011	40*	0.1	10	355.00
7102012	50	0.1	10	395.00
7102016	100	0.15	10	560.00

* As per Borosil Scientific standard

7103 - VOLUMETRIC PIPETTES

Class B, ASTM

- Complies with ASTM E-969-02
- Calibrated for delivery (TD, Ex)
- Generally used for accurate measurement and decanting of liquid
- Calibrated at 20°C



Till stock lasts				
Product Code	Capacity ml	Tolerance ± ml	Quantity Per Case	Price / Piece ₹
7103001	1	0.012	10	220.00
7103002	2	0.012	10	230.00
7103003	3	0.02	10	220.00
7103004	4	0.02	10	230.00
7103005	5	0.02	10	230.00
7103706	6	0.03	10	245.00
7103707	7	0.03	10	235.00
7103708	8	0.04	10	245.00
7103709	9	0.04	10	235.00
7103006	10	0.04	10	270.00
7103007	15	0.06	10	300.00
7103008	20	0.06	10	310.00
7103009	25	0.06	10	325.00
7103010	30*	0.06	10	325.00
7103011	40*	0.10	10	340.00
7103012	50	0.10	10	385.00
7103016	100	0.16	10	540.00

* As per Borosil Scientific standard

7106 - VOLUMETRIC PIPETTES

Class A, ASTM, Amber, with Individual Calibration Certificate

- Complies with ASTM E-969-02
- Calibrated for delivery (TD, Ex)
- Each pipette coded with unique identification number (UID) and supplied with calibration certificate with traceability to national standards
- Uniform amber colour protects liquids from light radiation with a wave-length between 300 nm and 500 nm
- Ideal for use with light-sensitive solutions
- Generally used for accurate measurement and decanting of liquid
- Calibrated and certified at 20°C



Pipettes

Product Code	Capacity ml	Tolerance ± ml	Quantity Per Case	Price / Piece ₹
7106001	1	0.006	10	760.00
7106002	2	0.006	10	760.00
7106005	5	0.01	10	830.00
7106006	10	0.02	10	865.00
7106008	20	0.03	10	930.00
7106009	25	0.03	10	930.00
7106012	50	0.05	10	1090.00
7106016	100	0.08	10	1445.00



2030 - MOHR PIPETTES

NABL Certified, Class A

- Complies with IS, ISO 835, Type I
- Graduated for delivery from zero mark to the last graduation mark
- Supplied with individual NABL calibration certificate showing actual volume dispensed and providing traceability to national standards
- Markings are made in permanent amber stain diffused into the surface of the glass for better visibility and durability
- Calibrated & certified at 27°C

Product Code	Capacity ml	Graduation Interval ml	Tolerance \pm ml	Quantity Per Case	Price / Piece ₹
2030P41	0.1	0.01	0.006	1	1375.00
2030P42	0.2	0.01	0.006	1	1375.00
2030P01	1	0.01	0.007	1	1335.00
2030P11	1	0.10	0.007	1	1485.00
2030P02	2	0.02	0.01	1	1400.00
2030P22	2	0.10	0.01	1	1335.00
2030P05	5	0.05	0.03	1	1490.00
2030P55	5	0.10	0.03	1	1375.00
2030P06	10	0.10	0.05	1	1650.00
2030P09	25	0.20	0.10	1	2085.00

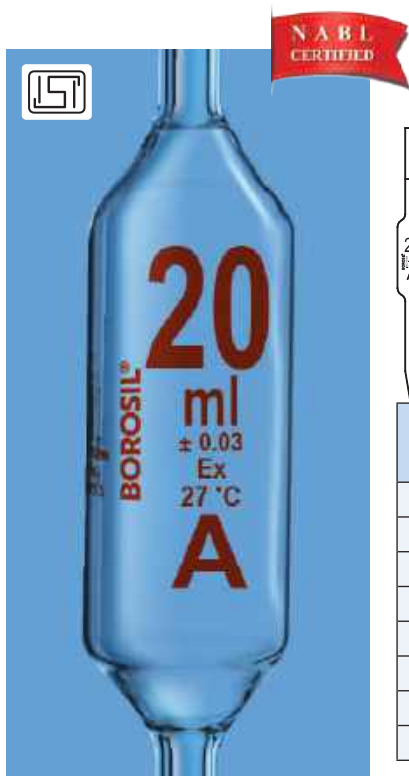

2040 - VOLUMETRIC PIPETTES

NABL Certified, Class A, with Individual Calibration Certificate

- Complies with IS 1117, ISO 648 **with ISI Mark**
- Calibrated for delivery (TD, Ex)
- Each pipette coded with unique identification number (UID) and supplied with NABL calibration certificate with traceability to national standards
- Generally used for accurate measurement and decanting of liquid
- Calibrated and certified at 27°C

Product Code	Capacity ml	Tolerance \pm ml	Quantity Per Case	Price / Piece ₹
2040001	1	0.008	1	1160.00
2040002	2	0.01	1	1240.00
2040005	5	0.015	1	1330.00
2040006	10	0.02	1	1405.00
2040008	20	0.03	1	1595.00
2040009	25	0.03	1	1710.00
2040012	50	0.05	1	2195.00
2040016	100	0.08	1	2900.00

INTRODUCING



CERTIFIED

Laboratory Glassware!

We are thrilled to announce a significant update to our laboratory glassware products!

In compliance with the recent Quality Control Order issued by the Central Government and in consultation with the Bureau of Indian Standards (BIS) dated 1st January 2024, we have commenced manufacturing select laboratory glassware products with the prestigious ISI mark.



What is the ISI Mark?

The **ISI mark** is a certification mark issued by the **Bureau of Indian Standards (BIS)**, the national standards body of India. It signifies that a product conforms to the specifications and quality standards set by BIS. The ISI mark ensures that the product is safe, reliable, and of good quality for consumers.

Benefits of the ISI Mark for Manufacturers

The **ISI mark** helps manufacturers ensure product quality, comply with regulations, and build consumer trust. It enhances market access, brand reputation, and competitiveness while promoting consistent quality and reducing liabilities. Overall, it supports business growth and symbolizes reliability.

Please contact CT Enterprises for quotation.

Email: sales@ctenterprises.in | Phone: +91 8977721310

Weighing Scoop

Borosil Weighing Scoops are primarily used when small quantities of powder, liquid or semi-solid material need to be weighed. The powder can be introduced into the receiving vessel through the tubular stem.



7200 - GLASS WEIGHING SCOOP

- Weighing scoops have an open tubular arm.
- Ideal for weighing small quantities of dyes and powders

Product Code	Capacity ml	Quantity Per Case	Price / Piece ₹
7200P45	0.5	10	320.00
7200001	1	10	285.00
7200002	2	10	285.00
7200003	3	10	230.00
7200076	6	10	305.00
7200006	10	10	345.00
NEW 7205706*	10	10	395.00

* jacketed weighing scoop

Mortar and Pestle

Made of borosilicate glass for fine grinding of high purity substances



7210 - GLASS MORTAR AND PESTLE

Inside Rough

- Inside surface is made rough to ensure fine grinding
- Designed with pour out for which allows easy decanting of liquids

Product Code	Top Diameter mm	Height* mm	Quantity Per Case	Price / Piece ₹
7210040	80	60	2	6940.00
7210041	100	75	2	8435.00
7210042	150	110	2	13745.00

* Height indicated is of mortar only

Based on your needs, we offer an assortment of centrifuge tubes, Folin-Wu Tubes. All are made from uniformly drawn high quality tubing for extended service life and your safety.

Tubes

7840 - FOLIN - WU BLOOD SUGAR TUBE

- Complies with IS 3740
- Made of uniformly drawn high quality tubing for extended service life
- The tube is calibrated at 12.5 ml and 25 ml



Product Code	Capacity ml	Approx O.D. x Length mm	Quantity Per Case	Price / Piece ₹
7840009	25	20 x 220	20	341.00

8060 - CENTRIFUGE TUBE

Plain

- Made of uniformly drawn high quality tubing for extended service life
- Designed with conical bottom for the higher density fraction collection at the bottom of the tube
- Consequently, even small amounts of solids can be collected and separated



Product Code	Capacity ml	Approx O.D. x Length mm	Quantity Per Case	Price / Piece ₹
8060007	15	17 x 120	100	92.00

8080 - CENTRIFUGE TUBE

Graduated

- Made of uniformly drawn high quality tubing for extended service life
- Designed with conical bottom for the higher density fraction collection at the bottom of the tube
- Consequently, even small amounts of solids can be collected and separated
- Graduated for greater precision



Product Code	Capacity ml	Approx O.D. x Length	Quantity Per Case	Price / Piece ₹
8080007	15	17 x 120	30	184.00
8080012	50	29 x 135	20	362.00

Amber colour Centrifuge tube available Product Code: 8081

Tubes



8084 - CENTRIFUGE TUBE

Graduated With I/C Glass Stopper

- Made of uniformly drawn high quality tubing for extended service life
- Designed with conical bottom for the higher density fraction collection at the bottom of the tube
- Consequently, even small amounts of solids can be collected and separated
- Graduated for greater precision
- Supplied with glass stopper

Product Code	Capacity ml	Approx O.D. x Length mm	Quantity Per Case	Price / Piece ₹
8084007	15	17 x 145	30	551.00
8084012	50	29 x 165	10	693.00



8090 - CENTRIFUGE TUBE

Graduated With PP Screw Cap

- Supplied with screw cap made of polypropylene
- Made of uniformly drawn high quality tubing for extended service life
- Designed with conical bottom for the higher density fraction collection at the bottom of the tube
- Consequently, even small amounts of solids can be collected and separated
- Graduated for greater precision

Product Code	Capacity ml	Approx O.D. x Length	Quantity Per Case	Price / Piece ₹
8090007	15	17 x 130	30	730.00
8090012	50	29 x 150	10	968.00

Amber colour Centrifuge tube available Product Code: 8091



8100 - Glass Stoppers

ISO / DIN, Penny head, Clear

Product Code	Stopper Number	Interchangeable Joint Size	Quantity Per Case	Price / Piece ₹
ISO / DIN Standard (Long Neck)				
8100A07	–	7 / 16	20	115.00
8100A10	–	10 / 19	20	120.00
8100A12	–	12 / 21	20	125.00
8100A14	–	14 / 23	20	125.00
8100A19	–	19 / 26	20	145.00
8100A24	–	24 / 29	20	285.00
8100A29	–	29 / 32	20	345.00
8100A34	–	34 / 35	20	360.00

8110 - Glass Stoppers

ASTM, Penny head, Clear

Product Code	Stopper Number	Interchangeable Joint Size	Quantity Per Case	Price / Piece ₹
ASTM Standard (Short Neck)				
8110009	# 9	9.4 / 14	20	135.00
8110013	# 13	13.4 / 14	20	145.00
8110016	# 16	16.5 / 15	20	285.00
8110019	# 19	19.7 / 17	20	345.00
8110022	# 22	22.05 / 20.5	20	360.00
8110027	# 27	27.15 / 21.5	20	380.00

HSN Code : 70179090



8300 - Polypropylene (PP) Stoppers

- Flat head, ISO standard

Product Code	Interchangeable Joint Size	Quantity Per Case	Price / Piece ₹
8300A07	7 / 16	20	60.00
8300A10	10 / 19	20	65.00
8300A012	12 / 21	20	70.00
8300A14	14 / 23	20	75.00
8300A19	19 / 26	20	85.00
8300A24	24 / 29	20	105.00
8300A29	29 / 32	20	135.00
8300A34	34 / 35	20	150.00

HSN Code : 39235010



8500 - Glass Stoppers

ISO / DIN, Flat Head, Clear

Product Code	Interchangeable Joint Size	Quantity Per Case	Price / Piece ₹
ISO / DIN Standard (Long Neck)			
8500A10	10/19	20	140.00
8500A12	12/21	20	165.00
8500A14	14/23	20	165.00
8500A19	19/26	20	195.00
8500A24	24/29	20	340.00
8500A29	29/32	20	415.00



8700 - Glass Stoppers

ISO / DIN, Flat Head, Amber

Product Code	Interchangeable Joint Size	Quantity Per Case	Price / Piece ₹
ISO / DIN Standard (Long Neck)			
8700A10	10/19	20	195.00
8700A12	12/21	20	250.00
8700A14	14/23	20	265.00
8700A19	19/26	20	300.00
8700A24	24/29	20	430.00
8700A29	29/32	20	480.00



Tubes



8320 - CENTRIFUGE TUBE HEAVY DUTY With Spout, Plain, Short Conical Bottom

- Made of uniformly drawn high quality tubing with increased wall thickness
- Spout allows easy decanting of liquids
- Designed with conical bottom for the higher density fraction collection at the bottom of the tube

Product Code	Capacity ml	Approx O.D. x Length mm	Quantity Per Case	Price / Piece ₹
8320011	40	29 x 116	20	249.00

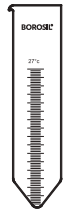

8340 - CENTRIFUGE TUBE HEAVY DUTY With Spout, Graduated, Short Conical Bottom

- Made of uniformly drawn high quality tubing with increased wall thickness
- Spout allows easy decanting of liquids
- Designed with conical bottom for the higher density fraction collection at the bottom of the tube
- Graduated tubes for greater precision

Product Code	Capacity ml	Approx O.D. x Length mm	Quantity Per Case	Price / Piece ₹
8340011	40	29 x 116	20	449.00

Graduated upto 10 ml in 0.5 ml and from 10 ml to 40 ml in 1 ml divisions



8400 - Glass Stoppers ISO / DIN, Penny head, Amber

Product Code	Stopper Number	Interchangeable Joint Size	Quantity Per Case	Price / Piece ₹
ISO / DIN Standard (Long Neck)				
8400A07	–	7 / 16	20	120.00
8400A10	–	10 / 19	20	145.00
8400A12	–	12 / 21	20	195.00
8400A14	–	14 / 23	20	195.00
8400A19	–	19 / 26	20	220.00
8400A24	–	24 / 29	20	340.00
8400A29	–	29 / 32	20	400.00
8400A34	–	34 / 35	20	435.00

8410 - Glass Stoppers ASTM, Penny head, Amber

Product Code	Stopper Number	Interchangeable Joint Size	Quantity Per Case	Price / Piece ₹
ASTM Standard				
8410009	# 9	9.4 / 14	20	160.00
8410013	# 13	13.4 / 14	20	190.00
8410016	# 16	16.5 / 15	20	340.00
8410019	# 19	19.7 / 17	20	420.00
8410022	# 22	22.05 / 20.5	20	440.00
8410027	# 27	27.15 / 21.5	20	455.00



The Adapter tube listed below are the most widely used ones, and will enable a laboratory to assemble its own apparatus using the Flasks and Condensers listed earlier. The joints are fully interchangeable and made to the same precision as all Borosil Scientific ground joints.

Adapters

8800 - ENLARGING CONNECTING ADAPTERS

- An outer interchangeable joint at the top and a smaller inner interchangeable joint at the base
- These joints are made to the same precision as all Borosil Scientific ground joints



Product Code	Socket Joint Size	Cone Joint Size	Quantity Per Case	Price / Piece ₹
8800A01	19 / 26	14 / 23	5	395.00
8800A02	24 / 29	14 / 23	5	490.00
8800A03	24 / 29	19 / 26	5	490.00
8800A04	29 / 32	19 / 26	5	585.00
8800A05	29 / 32	24 / 29	5	585.00
8800A06	34 / 35	19 / 26	5	755.00
8800A07	34 / 35	24 / 29	5	755.00
8800A08	34 / 35	29 / 32	5	755.00



8820 - REDUCTION CONNECTING ADAPTERS

- An outer interchangeable joint at the top and a smaller inner interchangeable joint at the base
- These joints are made to the same precision as all Borosil Scientific ground joints.



Product Code	Socket Joint Size	Cone Joint Size	Quantity Per Case	Price / Piece ₹
8820A09	29 / 32	34 / 35	5	760.00
8820A10	14 / 23	19 / 26	5	395.00
8820A11	14 / 23	24 / 29	5	490.00
8820A13	19 / 26	29 / 32	5	585.00
8820A14	19 / 26	34 / 35	5	755.00
8820A15	24 / 29	29 / 32	5	585.00
8820A16	24 / 29	34 / 35	5	755.00
8820A17	29 / 32	40 / 38	5	850.00
8820A18	19 / 26	24 / 29	5	490.00



8830 - RECEIVER BENT ADAPTER WITH VACUUM CONNECTION

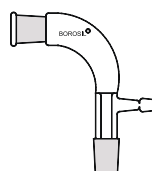

Product Code	Socket Joint Size	Cone Joint Size	Quantity Per Case	Price / Piece ₹
8830614	14 / 23	14 / 23	5	600.00
8830619	19 / 26	19 / 26	5	660.00
8830719	19 / 26	24 / 29	5	700.00
8830624	24 / 29	24 / 29	5	760.00
8830724	24 / 29	29 / 32	5	960.00
8830629	29 / 32	29 / 32	5	1060.00



• Adapters
• Test Tubes, Stirrer Rod
• Culture Tubes
• Watch Glass
• Sintered & Quartz Ware

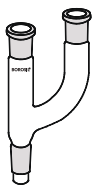

8831 - MULTIPLE ADAPTER With Two Parallel Necks

Product Code	Socket Joint Size	Cone Joint Size	Quantity Per Case	Price / Piece ₹
8831614	14 / 23	14 / 23	5	415.00
8831619	19 / 26	19 / 26	5	450.00
8831719	19 / 26	24 / 29	5	505.00
8831624	24 / 29	24 / 29	5	545.00
8831819	19 / 26	34 / 35	5	640.00
8831629	29 / 32	29 / 32	5	710.00

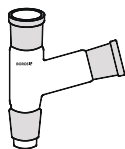

8832 - MULTIPLE ADAPTER With Two Necks

- With two neck - one Vertical & one at 45°

Product Code	Socket Joint Size	Cone Joint Size	Quantity Per Case	Price / Piece ₹
8832619	19 / 26	19 / 26	5	450.00
8832719	19 / 26	24 / 29	5	480.00
8832819	19 / 26	34 / 35	5	585.00

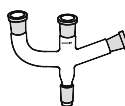

8833 - MULTIPLE ADAPTER With Three Necks

- With three necks - two parallel necks & one at 45°

Product Code	Socket Joint Size	Cone Joint Size	Quantity Per Case	Price / Piece ₹
8833A19	19 / 26	24 / 29	5	660.00
8833B19	19 / 26	29 / 32	5	760.00
8833C19	19 / 26	34 / 35	5	870.00
8833D19	19 / 26	45 / 40	5	1120.00

8834 - SWAN NECK ADAPTER

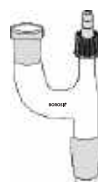

Product Code	Socket Joint Size	Cone Joint Size	Quantity Per Case	Price / Piece ₹
8834619	19 / 26	19 / 26	5	440.00
8834719	19 / 26	24 / 29	5	345.00
8834624	24 / 29	24 / 29	5	535.00
8834724	24 / 29	34 / 35	5	625.00

8835 - ADAPTER CONE / RUBBER TUBING



Product Code	Socket Joint Size	Quantity Per Case	Price / Piece ₹
8835A10	10 / 19	5	235.00
8835A14	14 / 23	5	255.00
8835A19	19 / 26	5	310.00
8835A24	24 / 29	5	345.00
8835A29	29 / 32	5	480.00

8836 - ADAPTER CONE - FLEXIBLE TUBING



Product Code	Socket Joint Size	Quantity Per Case	Price / Piece ₹
8836A14	14 / 23	5	255.00
8836A19	19 / 26	5	305.00
8836A24	24 / 29	5	345.00
8836A29	29 / 32	5	430.00
8836B10	10 / 19	5	285.00
8836B14	14 / 23	5	390.00
8836B19	19 / 26	5	390.00
8836B24	24 / 29	5	450.00
8836B29	29 / 32	5	545.00





8837 - ADAPTER RECEIVER Straight Socket To Rubber

Product Code	Socket Joint Size	Quantity Per Case	Price / Piece ₹
8837A14	14 / 23	5	255.00
8837A19	19 / 26	5	305.00
8837A24	24 / 29	5	335.00
8837A34	34 / 35	5	440.00

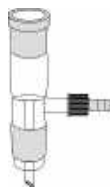

8838 - ADAPTER RECEIVER Straight With Vacuum

Product Code	Socket Joint Size	Cone Joint Size	Quantity Per Case	Price / Piece ₹
8838614	14 / 23	14 / 23	5	345.00
8838714	14 / 23	19 / 26	5	370.00
8838814	14 / 23	24 / 29	5	450.00
8838619	19 / 26	19 / 26	5	440.00
8838719	19 / 26	24 / 29	5	480.00
8838624	24 / 29	24 / 29	5	530.00
8838724	24 / 29	29 / 32	5	640.00



8839 - ADAPTER RECEIVER Bent With Vent

Product Code	Socket Joint Size	Cone Joint Size	Quantity Per Case	Price / Piece ₹
8839614	14 / 23	14 / 23	5	345.00
8839619	19 / 26	19 / 26	5	400.00
8839719	19 / 26	24 / 29	5	480.00
8839624	24 / 29	24 / 29	5	530.00
8839629	29 / 32	29 / 32	5	760.00

8840 - ADAPTER CONES SCREW THREAD



Product Code	Socket Joint Size	Quantity Per Case	Price / Piece ₹
8840A14	14 / 23	5	370.00
8840A19	19 / 26	5	370.00
8840A24	24 / 29	5	430.00
8840A29	29 / 32	5	555.00

8841 - SLOPPING PLANE STILL HEAD

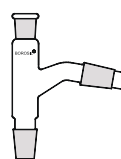

Product Code	Flask Cone	Cond. Cone	Socket	Quantity Per Case	Price / Piece ₹
8841610	10 / 19	10 / 19	10 / 19	5	545.00
8841614	14 / 23	14 / 23	14 / 23	5	570.00
8841619	19 / 26	19 / 26	14 / 23	5	650.00
8841819	19 / 26	19 / 26	19 / 26	5	690.00
8841724	24 / 29	19 / 26	14 / 23	5	725.00
8841624	24 / 29	24 / 29	19 / 26	5	790.00
8841729	29 / 32	19 / 26	14 / 23	5	805.00
8841629	29 / 32	29 / 32	14 / 23	5	1150.00
8841634	34 / 35	19 / 26	14 / 23	5	925.00
8841734	34 / 35	24 / 29	14 / 23	5	1080.00
8841834	34 / 35	34 / 35	14 / 23	5	3090.00

8844 - ADAPTER RECEIVER

Multiple Connectivity

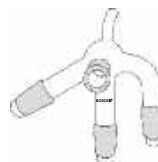

Product Code	Socket Joint Size	Cone Joint Size	Quantity Per Case	Price / Piece ₹
8844614	14 / 23	14 / 23	5	1060.00
8844714	14 / 23	19 / 26	5	1120.00
8844619	19 / 26	19 / 26	5	1245.00

Adapters

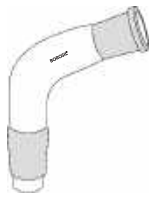

8845 - ADAPTER RECEIVER Plain Bent

Product Code	Socket Joint Size	Cone Joint Size	Quantity Per Case	Price / Piece ₹
8845619	19 / 26	19 / 26	5	400.00
8845719	19 / 26	24 / 29	5	440.00
8845624	24 / 29	24 / 29	5	530.00
8845629	29 / 32	29 / 32	5	760.00



8846 - ADAPTER RECOVERY BENT With Sloping End

Product Code	Socket Joint Size	Cone Joint Size	Quantity Per Case	Price / Piece ₹
8846614	14 / 23	14 / 23	5	305.00
8846724	24 / 29	14 / 23	5	400.00
8846619	19 / 26	19 / 26	5	400.00
8846824	24 / 29	19 / 26	5	420.00
8846729	29 / 32	19 / 26	5	545.00
8846734	34 / 35	19 / 26	5	585.00
8846624	24 / 29	24 / 29	5	420.00
8846834	34 / 35	24 / 29	5	650.00
8846634	34 / 35	34 / 35	5	725.00



8847 - ADAPTER RECOVERY Bent Vertical

Product Code	Socket Joint Size	Cone Joint Size	Quantity Per Case	Price / Piece ₹
8847614	14 / 23	14 / 23	5	430.00
8847619	19 / 26	19 / 26	5	530.00
8847724	24 / 29	14 / 23	5	555.00
8847624	24 / 29	24 / 29	5	660.00
8847629	29 / 32	29 / 32	5	870.00

8849 - CLAISEN HEAD SLOPING

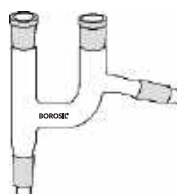

Product Code	Socket Joint Size	Cone Joint Size	Quantity Per Case	Price / Piece ₹
8849614	14 / 23	14 / 23	5	710.00
8849619	19 / 26	19 / 26	5	790.00
8849724	24 / 29	19 / 26	5	830.00
8849624	24 / 29	24 / 29	5	900.00
8849629	29 / 32	29 / 32	5	970.00
8849734	34 / 35	24 / 29	5	1035.00

8850 - ADAPTER RECEIVER

Plain Vertical



Product Code	Socket Joint Size	Cone Joint Size	Quantity Per Case	Price / Piece ₹
8850614	14 / 23	14 / 23	5	650.00
8850719	19 / 26	24 / 29	5	710.00
8850724	24 / 29	29 / 32	5	805.00

8851 - SPLASH HEAD

Vertical, Pear Shape

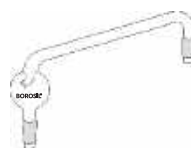

Product Code	Socket Joint Size	Cone Joint Size	Quantity Per Case	Price / Piece ₹
8851619	19 / 26	19 / 26	5	805.00
8851724	24 / 29	19 / 26	5	830.00
8851624	24 / 29	24 / 29	5	1035.00
8851629	29 / 32	29 / 32	5	1120.00

Adapters

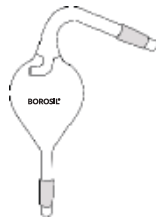

8852 - SPLASH HEAD SLOPING Pear Shape

Product Code	Socket Joint Size	Cone Joint Size	Quantity Per Case	Price / Piece ₹
8852619	19 / 26	19 / 26	5	760.00
8852724	24 / 29	19 / 26	5	805.00
8852624	24 / 29	24 / 29	5	870.00
8852629	29 / 32	29 / 32	5	900.00



8853 - STEAM DISTILLATION HEADS

Product Code	Socket Joint Size	Cone Joint Size	Quantity Per Case	Price / Piece ₹
8853724	24 / 29	19 / 26	5	1120.00
8853734	34 / 35	19 / 26	5	1370.00
8853834	34 / 35	24 / 29	5	1410.00

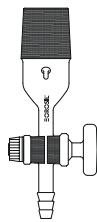

8854 - ADAPTOR Straight cone with stopcock

Product Code	Cone Joint Size	Stopcock Bore mm	Quantity Per Case	Price / Piece ₹
8854014	14 / 23	2	5	1670.00
8854019	19 / 26	2	5	1690.00
8854024	24 / 29	2	5	1800.00
8854029	29 / 32	2	5	2010.00
8854034	34 / 35	2	5	2340.00

8855 - ADAPTOR

Straight Socket With Stopcock

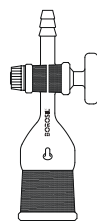

Product Code	Cone Joint Size	Stopcock Bore mm	Quantity Per Case	Price / Piece ₹
8855014	14 / 23	2	5	1930.00
8855019	19 / 26	2	5	1945.00
8855024	24 / 29	2	5	2085.00
8855029	29 / 32	2	5	2220.00
8855034	34 / 35	2	5	2655.00

8856 - ADAPTOR

Bent Cone With Stopcock



Product Code	Cone Joint Size	Stopcock Bore mm	Quantity Per Case	Price / Piece ₹
8856014	14 / 23	2	5	1930.00
8856019	19 / 26	2	5	1945.00
8856024	24 / 29	2	5	2085.00
8856029	29 / 32	2	5	2220.00
8856034	34 / 35	2	5	2520.00

8857 - ADAPTOR

Bent Socket With Stopcock

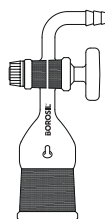

Product Code	Cone Joint Size	Stopcock Bore mm	Quantity Per Case	Price / Piece ₹
8857014	14 / 23	2	5	2055.00
8857019	19 / 26	2	5	2070.00
8857024	24 / 29	2	5	2205.00
8857029	29 / 32	2	5	2525.00
8857034	34 / 35	2	5	2760.00



8861 - THERMOMETER POCKET Long Type

Product Code	Cone Joint Size	Stopcock Bore mm	Quantity Per Case	Price / Piece ₹
8861014	14 / 23	2	10	490.00
8861019	19 / 26	2	10	625.00
8861024	24 / 29	2	10	695.00
8861029	29 / 32	2	10	1120.00
8861034	34 / 35	2	10	1315.00



8862 - THERMOMETER POCKET Short Type

Product Code	Cone Joint Size	Stopcock Bore mm	Quantity Per Case	Price / Piece ₹
8862014	14 / 23	2	10	545.00
8862019	19 / 26	2	10	660.00
8862024	24 / 29	2	10	755.00

Culture Tubes

Round Bottom, Clear with PP Cap

- Supplied with polypropylene cap and PTFE Liner (except 150 ml), autoclavable at 121°C
- Designed with special caps to facilitate handling and sealing
- The ideal replacement for media culture bottles



Please contact CT Enterprises for quotation.

Email: sales@ctenterprises.in | Phone: +91 8977721310

Test Tubes



9800 - TEST TUBES

With Rim

- Complies with IS 2618, DIN / ISO 4142
- Designed with a round bottom and a rim
- Made thick-walled, mechanically very resistant
- High thermal shock resistance

Product Code	Capacity ml	Approx O.D. x Length mm	Quantity Per Case	Price / Piece ₹
9800U01	3	10 x 75	800	11.00
9800U02	5	12 x 75	800	11.00
9800U03	7	12 x 100	800	16.00
9800U15	4	13 x 55*	800	18.00
9800U04	13	15 x 125	800	20.00
9800U05	15	15 x 150	400	23.00
9800U06	27	18 x 150	400	24.00
9800U07	38	25 x 100#	200	30.00
9800U08	55	25 x 150	200	36.00
9800U09	70	25 x 200	100	48.00
9800U10	100	32 x 200	50	72.00
9800U11	170	38 x 200	50	86.00

* IS : 3740 for tube widal

Not covered in the standard

9801 - TUBE FOR CULTURE COLLECTION

- Designed with a round bottom
- Thick walled and high mechanical resistance
- High thermal shock resistance
- Used for blood and microbial culturing

Product Code	Approx O.D. x Length mm	Quantity Per Case	Price / Piece ₹
9801U01	7 x 127	200	32.00

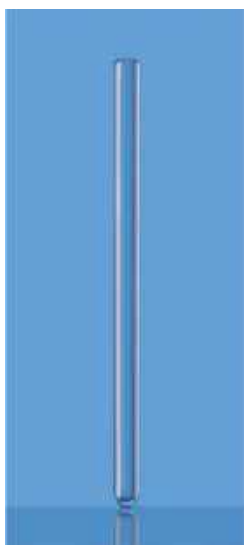

9820 - TEST TUBES

Without Rim

- Complies with IS 2618, DIN / ISO 4142
- Designed with a round bottom and without rim
- Made thick-walled, mechanically very resistant
- High thermal shock resistance



Product Code	Capacity ml	Approx O.D. x Length mm	Quantity Per Case	Price / Piece ₹
9820U16	1	7 x 60*	800	10.00
9820U01	3	10 x 75***	800	10.00
9820U02	5	12 x 75**/***	800	10.00
9820U03	7	12 x 100***	800	16.00
9820U17	8	12 x 125***	800	17.00
9820U04	13	15 x 125	800	20.00
9820U05	15	15 x 150	400	23.00
9820U12	12	16 x 100***	800	22.00
9820U18	20	16 x 150***	400	27.00
9820U06	27	18 x 150	400	24.00
9820U19	25	19 x 125***	400	27.00
9820U07	38	25 x 100#	200	30.00
9820U08	55	25 x 150***	200	36.00
9820U09	70	25 x 200	100	48.00
9820U10	100	32 x 200	50	72.00
9820U11	170	38 x 200	50	86.00

* IS:3740 - 1966 for DURHAM FERMENTATION

** IS:3740 - 1966 for KAHN & WASSERMAN TEST

*** IS:3740 - 1966 for BACTERIOLOGICAL TEST

Not covered in the standard



9821 - DISSOLUTION TUBE

Without Rim

- Designed with flat bottom and without rim
- High thermal shock resistance
- Used for pathological tests and disintegration apparatus

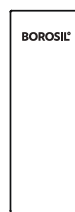

Product Code	Approx O.D. x Length mm	Quantity Per Case	Price / Piece ₹
9821U42	12 x 75	800	27.00
9821U61	18 x 100	400	53.00



Test Tubes



9822 - DISSOLUTION TUBE With Rim

- Designed with flat bottom and with rim
- High thermal shock resistance
- Used for pathological tests and disintegration apparatus

Product Code	Approx O.D. x Length mm	Quantity Per Case	Price / Piece ₹
9822U04	14 x 110	800	49.00
9822U13	16 x 98	400	54.00
9822U07	18 x 55	100	44.00
9822U08	18 x 100	200	54.00
9822U06	18 x 138	400	59.00
9822U19	19 x 103	200	64.00



9829 - TEST TUBE

Plain, With I/C Glass Stopper

- Supplied with interchangeable glass stopper
- Made thick-walled, mechanically very resistant
- High thermal shock resistance

Product Code	Capacity ml	Approx O.D. x Length mm	Stopper Size	Quantity Per Case	Price / Piece ₹
9829006	10	17 x 160	10 / 19	10	255.00
9829007	15	19 x 150	14 / 23	10	275.00
9829008	20	19 x 160	14 / 23	10	295.00
9829010	30	25 x 155	19 / 26	10	305.00
9829012	50	25 x 200	19 / 26	10	330.00
9829016	100	34 x 210	24 / 29	10	490.00



9830 - GRADUATED TEST TUBE With I/C Glass Stopper

- Supplied with interchangeable glass stopper
- Graduations in amber enamel
- Made thick-walled, mechanically very resistant
- High thermal shock resistance
- These test tubes are graduated for greater precision

Product Code	Capacity ml	Approx O.D. x Length mm	Stopper Size	Quantity Per Case	Price / Piece ₹
9830006	10	17 x 160	10 / 19	10	276.00
9830007	15	19 x 150	14 / 23	10	314.00
9830008	20	19 x 160	14 / 23	10	330.00
9830010	30	25 x 155	19 / 26	10	341.00
9830012	50	25 x 200	19 / 26	10	357.00
9830016	100	34 x 210	24 / 29	10	530.00

9831 - GRADUATED TEST TUBE

With I/C Glass Stopper, Amber

- Supplied with interchangeable glass stopper
- Graduations in white enamel
- Amber coating on exterior surfaces to facilitate use with light sensitive solutions
- Made thick-walled, mechanically very resistant
- High thermal shock resistance
- These test tubes are graduated for greater precision

Product Code	Capacity ml	Approx O.D. x Length mm	Stopper Size	Quantity Per Case	Price / Piece ₹
9831006	10	17 x 160	10 / 19	10	400.00
9831007	15	19 x 150	14 / 23	10	425.00
9831008	20	19 x 160	14 / 23	10	435.00
9831010	30	25 x 155	19 / 26	10	485.00
9831012	50	25 x 200	19 / 26	10	510.00
9831016	100	34 x 210	24 / 29	10	720.00

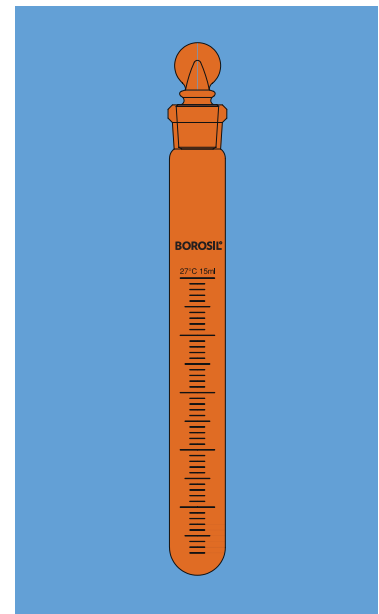

9835 - COD DIGESTION TUBE

- Made from thick-walled and mechanically resistant borosilicate glass
- Used in COD disintegration



Product Code	Approx O.D. x Length mm	Quantity Per Case	Price / Piece ₹
9835A01	36 x 205	10	573.00
9835001	39 x 205	10	573.00



9837 - METHYLENE BLUE REDUCTION TEST TUBE



- Use for Methylene Blue Dye Reduction Test for Raw Milk Quality
- Made thick-walled, mechanically very resistant
- High thermal shock resistance
- Calibrated at 27°C

Product Code	Product description	Approx O.D. x Length mm	Quantity Per Case	Price / Piece ₹
9837006	Single marking 10ml	16 x 150 mm	10	40.00
9837711	Double marking 10ml & 11ml	16 x 150 mm	10	48.00



Test Tubes

Stirrer Rod / Culture Tubes

Stirrers are used in laboratories for mixing of liquids and decanting the supernatants. Stir rods with blade helps in creating some turbulence and allows efficient mixing of solutions. BOROSIL Scientific stirrers are made of 3.3 borosilicate glass and equipped with a chemically inert PTFE blade to maintain the purity of substances while mixing.

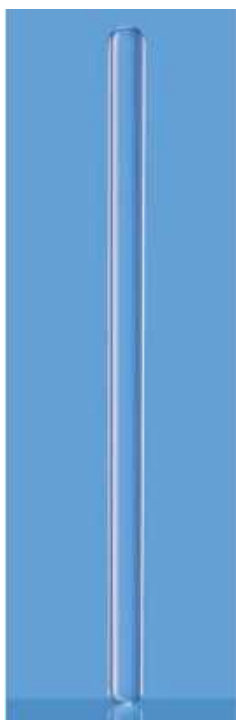

9850 - GLASS STIRRER ROD

Product Code	Approx O.D. x Length mm	Quantity Per Case	Price / Piece ₹
9850107	7 x 150	20	37.00
9850207	7 x 205	20	47.00
9850307	7 x 255	20	47.00
9850407	7 x 305	20	74.00
9850109	9 x 150	20	47.00
9850209	9 x 205	20	74.00
9850309	9 x 255	20	84.00
9850409	9 x 305	20	84.00

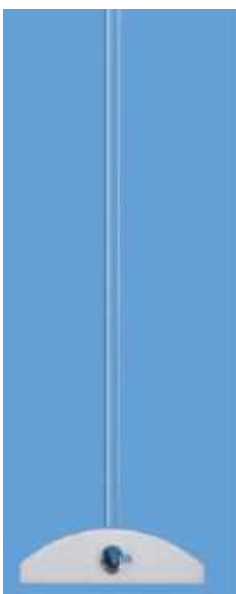

9860 - GLASS STIRRER ROD With PTFE Blade

- Provided with chemically inert PTFE blade
- Ideal for very sensitive samples
- Application in synthetic laboratory

Product Code	Shaft Dia x Length mm	Blade width mm	Socket	Suitable for flask capacity	Quantity Per Case	Price / Piece ₹
9860065	6 x 450	50	19 / 26	500 ml	10	465.00
9860071	6 x 450	75	24 / 29	1000 ml	10	585.00
9860077	8 x 600	100	34 / 35	2000 ml	5	745.00
9860080	8 x 600	125	34 / 35	5000 ml	5	820.00
9860081	10 x 750	150	55 / 44	10000 ml	5	1465.00
9860087	10 x 750	200	55 / 44	20000 ml	5	1635.00

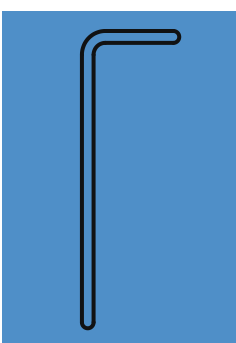

9865 - GLASS L SHAPED SPREADER

- Made of 3.3 borosilicate glass
- Smooth glass surface hence no chances of agar layer disruption while spreading
- Easy to clean and autoclavable at 121°C
- Used for inoculating microbial cultures on agar plates

Product Code	Approx OD x Length mm	Quantity Per Case	Price / Piece ₹
9865683	6 x 150	100	100.00

9900 - CULTURE TUBES

Round Bottom, Clear, With PP Cap

- Supplied with polypropylene cap and PTFE Liner (except 150 ml), autoclavable at 121°C
- Designed with special caps to facilitate handling and sealing
- The ideal replacement for media culture bottles

Product Code	Capacity ml	Approx O.D. x Length mm	Quantity Per Case	Price / Piece ₹
9900005	5	16 x 75	100	76.00
9900006	10	16 x 125	100	81.00
9900010	30	25 x 100	100	98.00
9900012	50	25 x 150	50	103.00
9900013	60	25 x 200	50	103.00
9900018	150#	38 x 200	50	234.00

All caps are Polypropylene with PTFE liner, except 150 ml

#Blue colour cap without PTFE liner & autoclavable up to 140°C



9901 - CULTURE TUBES

Round Bottom, Amber, With PP Cap

- Supplied with polypropylene cap and PTFE Liner (except 150 ml), autoclavable at 121°C
- The uniform amber colour is highly durable and protects light sensitive media and solutions
- Designed with special caps to facilitate handling and sealing
- The ideal replacement for media culture bottles

Product Code	Capacity ml	Approx O.D. x Length mm	Quantity Per Case	Price / Piece ₹
9901005	5	16 x 75	100	130.00
9901006	10	16 x 125	100	173.00
9901010	30	25 x 100	100	189.00
9901013	60	25 x 200	50	249.00
9901018	150#	38 x 200	50	1114.00

All caps are Polypropylene with PTFE liner, except 150 ml

#Blue colour cap without PTFE liner & autoclavable up to 140°C



9910 - CULTURE TUBE

Flat Bottom, Clear, With PP Cap

- Supplied with polypropylene cap and PTFE Liner (except 150 ml), autoclavable at 121°C
- Designed with flat bottom for convenient storage and special caps to facilitate handling and sealing
- The ideal replacement for for Bijou, Mc Cartney and universal bottles

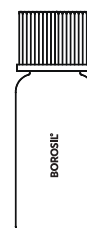

Product Code	Capacity ml	Approx O.D. x Length mm	Quantity Per Case	Price / Piece ₹
9910005	5	16 x 50	100	71.00
9910006	10	25 x 50	100	86.00
9910007	15	25 x 57	100	86.00
9910008	20	25 x 72	100	92.00
9910010	30	25 x 95	100	98.00
9910012	50	25 x 145	50	103.00



Stirrer Rod /
Culture Tubes



9911 - CULTURE TUBE

Flat Bottom, Amber, With PP Cap

- Supplied with polypropylene cap and PTFE Liner (except 150 ml), autoclavable at 121°C
- The uniform amber colour is highly durable and protects light sensitive media and solutions
- Designed with flat bottom for convenient storage and special caps to facilitate handling and sealing
- The ideal replacement for for Bijou, Mc Cartney and universal bottles

Product Code	Capacity ml	Approx O.D. x Length mm	Quantity Per Case	Price / Piece ₹
9911005	5	16 x 50	100	130.00
9911006	10	25 x 50	100	179.00
9911007	15	25 x 57	100	179.00
9911008	20	25 x 72	100	211.00
9911010	30	25 x 95	100	222.00



9913 - CERTIFIED SAMPLING & STORAGE VIALS

- Made of 5.1 expansion borosilicate glass conforming to USP type I, ASTM E438
- Supplied with high quality polypropylene cap with a PTFE liner, autoclavable at 121°C
- Write on patch for easy labelling and identification
- Complies glass composition and spectral transmission test as per USP chapter 660 USP 40 ad EP 9.0
- Packed in ISO "Class 8" clean room facility
- Supplied in amber and clear form
- Amber colour protects light sensitive materials
- Ideal for storage of working standards, sampling of raw materials, chemical and biological samples

Product Code	Capacity ml	Approx Mouth ID in mm	Dimension O.D. x Length in mm	Case Lot (MOQ)	Price Per Piece ₹
9913003	3	10	16 x 36	1200	37.00
9913005	5	10	16 x 55	900	44.00
9913006	10	16.5	24 x 50	1050	71.00
9913007	15	16.5	24 x 58	900	76.00
9913008	20	16.5	24 x 70	750	92.00
9913010	30	16.5	24 x 95	600	108.00

9914 - CERTIFIED SAMPLING & STORAGE VIAL, CLEAR

- Bullet points common for both 9913 and 9914

Product Code	Capacity ml	Approx Mouth ID in mm	Dimension O.D. x Length in mm	Case Lot (MOQ)	Price Per Piece ₹
9914003	3	10	16 x 36	1200	27.00
9914005	5	10	16 x 55	900	34.00
9914006	10	16.5	24 x 50	1050	44.00
9914007	15	16.5	24 x 58	900	50.00
9914008	20	16.5	24 x 70	750	57.00
9914010	30	16.5	24 x 95	600	67.00



Watch Glass

Watch glasses are used most often in chemical laboratories for different applications such as evaporating liquids, weighing of substances, covers for beakers to prevent contamination. BOROSIL Scientific watch glass is designed with an optimum concave to suit these applications.

9986 - WATCH GLASSES

S - Line

- Made of sodalime glass
- A special process is used that results in an absolutely flat curved surface
- High clarity, free of bubbles
- All of them are moulded to the same radius of curvature for convenient stacking

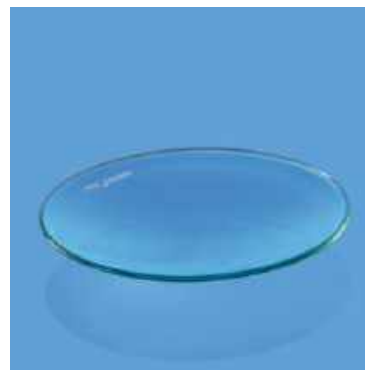
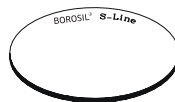

Product Code	Size mm	Quantity Per Case	Price / Piece ₹
9986072	80	50	120.00
9986077	100	50	135.00
9986079	120	20	145.00
9986081	150	20	195.00

Still using non-certified vials for storage of expensive **working standards ?**

BOROSIL®
is right here with a solution

PROUDLY MADE IN  **india**

Certified Sampling and Storage Vials

An ideal container for storage of working standard solutions

Made from 5.1 Low Expansion Borosilicate Glass



Watch Glass

Sintered Ware

Technical Data

Borosil Sintered Glassware is used for filtration of liquids and gases in the laboratory. It has a non-corrosive and reusable porous glass disc as the filter media. It is also used for gas washing, dispersion and absorption.

The Sintered Disc is manufactured by crushing Borosil glass, and then powdering, cleaning and separating it into various mesh sizes, and finally, fusing it together in the form of a Disc. Sintered Discs are classified into 5 grades - G1, G2, G3, G4 and G5. The grades are defined in terms of the maximum pore size that is obtained by measuring the pressure at which the first air bubble breaks away from the filter, under specified conditions. The pressure differential is then used to calculate the equivalent capillary diameters in microns. The desired pore size is obtained by controlling the grain size, firing time, temperature and thickness of the Disc. Each Disc is tested and graded individually.

The pore diameters are reasonably uniform, which ensures the required flow rate through the filter. The flow rate further depends on the pressure differential between the two sides of the Disc, the free area of the Disc, viscosity of the fluid being filtered, and other factors. There is a fair amount of uniformity in the pore size of different Discs of the same size and grade. Hence, the results from two or more Discs of the same size and grade will be uniform, thereby ensuring reproducible analytical results.

The Discs have maximum surface hardness and hence, the glass powder does not get scraped off while cleaning or with chemicals. The filters do not shed particles during usage.

The Discs are sealed to tubing without blocking the pores. They are then annealed properly in automatically controlled Lehrs.

Porosity Grades And Their General Use

Porosity Grade	Pore Size (Microns)	General use
1	90-150	Filtration of coarse materials / precipitates, gas dispersion, gas washing, extractor bed, support for other filter materials.
2	40-90	Filtration of medium precipitates gas dispersion, gas washing.
3	15-40	Filtration of fine grain precipitates. Analytical work with medium precipitates. Mercury filtration
4	5-15	Analytical work with fine and very fine precipitates. Non return mercury valves.
5	1-2	Bacteriological filtration.

Chemical Durability

Borosil Sintered Ware is manufactured with the same high quality material of which all Borosil brand borosilicate laboratory glassware is made, ensuring excellent resistance to chemical attack.

Operating Pressure

Sintered Discs, and the glassware that incorporates them, are designed mainly for the application of vacuum or for passage of gases at relatively low pressure. In all cases, the differential pressure must not exceed 100 KN / m² (15 psi).

Thermal Limitations

Sintered Ware has a lower level of resistance to thermal shock as compared to standard Borosil glassware. Therefore, articles of Sintered Ware should not be subjected to excessive temperature changes or direct flames.

Borosil Sintered Crucibles are especially suitable for drying to constant weight. Dry Sintered Crucibles at room temperature, can be placed directly into a drying oven. Sintered Ware may safely be heated in a furnace to 500°C without any adverse effects, while ensuring that the cycle of heating and cooling is gradual. It is recommended that the rate of heating does not exceed 20°C/min. This prevents internal strains caused by excessive temperature differences between the surrounding glass vessel and the Sintered Disc that, in turn, can lead to fracture of the apparatus.

When cold and damp, Sintered Ware of porosity grades 4 and 5 should never be subjected to a sudden temperature change as the evolution of steam may generate pressure within the filter, sufficient to crack it.

Filtration Apparatus should be kept on its rim (stem upwards) in an oven or steriliser. A perforated support base is advantageous for air convection in case of pipeline filters. By using heat insulating material such as asbestos, care should be taken to avoid premature heating near the filter seal. The apparatus should remain in the oven or steriliser during cooling, to prevent excessively fast cooling.

Cleaning Of Sintered Ware

New Sintered Filters should be washed carefully with hot hydrochloric acid, and then rinsed with distilled water before use. Such treatment ensures that all loose particles are removed from the Filter.

It is advisable to clean all Sintered Filters thoroughly, immediately after use, as cleaning is easiest at this time, and it also reduces the risk of contamination in the next use.

Many precipitates can be removed from the filter by back-flushing with water. However, great care must be taken with large diameters and fine filters, as positive pressures on the reverse side may break the filter.

Under no circumstances should Sintered Apparatus be subjected to mains water pressure when back-flushing, as in most instances this leads to fractured filters.

Drawing water through the filter from the reverse side, by means of a vacuum pump, is also effective.

Filters clogged with dust and dirt during gas filtration can be restored by treatment with warm detergent solution, followed by blowing clean air through, from the clean side of the filter. Dirt particles are brought to the surface by the foam, and removed by rinsing with water.

Some precipitates that clog the filter may be removed by chemical cleaning, as indicated below:

- **Fats and grease**
Carbon tetrachloride or suitable organic solvent
- **Albumen glucose:**
Hot ammonia or hydrochloric acid, mixture of hot concentrated sulphuric and nitric acids
- **Organic substances :**
'Chromic' acid cleaning solution* or concentrated sulphuric acid containing a little potassium nitrate or perchlorate (0.5%) (may need to be soaked overnight)
- **Copper or iron oxide :**
Hot concentrated hydrochloric acid with potassium chlorate.
- **Barium sulphate :**
Hot concentrated sulphuric acid
- **Mercury Residues :**
Hot concentrate nitric acid
- **Mercury Sulphide :**
Hot aqua regia
- **Silver chloride :**
Ammonia or sodium hyposulphite
- **Stannic oxide :**
Boiling sulphuric acid**

Alumina or silica residues :

2% hydrofluoric acid followed by concentrated sulphuric acid. Rinse immediately with distilled water and then with acetone. Continue rinsing until no trace of acid remains.

High concentrations of hydrofluoric acid, hot phosphoric acid or caustic alkali solutions should never be used for cleaning. Using these causes a rapid deterioration in the filter and an increase in pore size.

* For bacteriological, pharmaceutical and biological work, 'chromic' acid cleaning solution should be avoided in view of the biological effect of chromium ions.

** Boiling sulphuric acid may introduce undue thermal strain. It is therefore advisable to leave the item in the acid to cool.



36060 - BUCHNER FUNNEL With Sintered Disc

- Made of 3.3 borosilicate glass
- Especially useful where the filter paper may be attacked by filtered material
- Generally used in qualitative inorganic analysis and preparative chemistry
- Resistant to corrosion and heat

Product Code	Capacity ml	Porosity Grade	Dia of Disc mm	Approx Height mm	Stem Dia mm	Quantity Per Case	Price / Piece ₹
3606058	35	1	30	130	8	5	740.00
3606658	35	2	30	130	8	5	705.00
3606758	35	3	30	130	8	5	740.00
3606858	35	4	30	130	8	5	705.00
3606958	35	5	30	130	8	5	885.00
3606072	80	1	35	142	8	5	1370.00
3606672	80	2	35	142	8	5	1370.00
3606772	80	3	35	142	8	5	1370.00
3606872	80	4	35	142	8	5	1370.00
3606972	80	5	35	142	8	5	1660.00
3606020	200	1	68	215	13	5	2130.00
3606620	200	2	68	215	13	5	2130.00
3606720	200	3	68	215	13	5	2130.00
3606820	200	4	68	215	13	5	2130.00
3606920	200	5	68	215	13	5	2475.00
3606024	500	1	92	258	17	2	5030.00
3606624	500	2	92	258	17	2	5030.00
3606724	500	3	92	258	17	2	5030.00
3606824	500	4	92	258	17	2	5030.00
3606924	500	5	92	258	17	2	6585.00
3606029	1000	1	124	276	19	2	9725.00
3606629	1000	2	124	276	19	2	9725.00
3606729	1000	3	124	276	19	2	9725.00
3606829	1000	4	124	276	19	2	9725.00
3606929	1000	5	124	276	19	2	12430.00

32060 - GOOCH CRUCIBLE

Low Form, With Sintered Disc

- Made of 3.3 borosilicate glass
- Particularly adapted to analytical work where precipitates are dried to constant weight at 110°C
- Crucibles should not be subjected to sudden temperature changes
- In order to avoid strain, they should not be removed from the furnace until the temperature has dropped to 250°C
- Gooch Crucible is used for metal casting and analysis

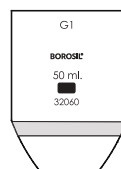

Product Code	Capacity ml	Porosity Grade mm	Dia of Disc mm	Approx Height	Quantity Per Case	Price / Piece ₹
3206007	15	1	20	50	10	510.00
3206607	15	2	20	50	10	510.00
3206707	15	3	20	50	10	510.00
3206807	15	4	20	50	10	510.00
3206907	15	5	20	50	10	625.00
3206010	30	1	30	60	10	675.00
3206610	30	2	30	60	10	675.00
3206710	30	3	30	60	10	675.00
3206810	30	4	30	60	10	675.00
3206910	30	5	30	60	10	835.00
3206012	50	1	40	65	10	780.00
3206612	50	2	40	65	10	780.00
3206712	50	3	40	65	10	780.00
3206812	50	4	40	65	10	780.00
3206912	50	5	40	65	10	975.00

32061 - TUBE FOR GOOCH CRUCIBLE

- Made of 3.3 borosilicate glass
- Suitable for use with Borosil's Scientific Gooch Crucible with sintered disc



Product Code	Approx O.D. x Length mm	Quantity Per Case	Price / Piece ₹
3206127	27 x 150	5	225.00
3206136	36 x 160	5	320.00
3206156	56 x 170	10	475.00

These are suitable for use with our filtering crucibles Gooch Type with sintered disc, No. 32060 lower part 8 mm O.D. x 75 mm length in all sizes.



Sintered Ware

Boron Free Transparent Silica

Borosil Fused Silica 99.95% SiO₂ surpasses all of the desirable chemical and weathering durability properties usually associated with opaque Silica ware. We manufacture as per IS and BS Standards.



a) There is little or no visible surface change or damage to silica with prolonged exposure to water, atmospheric gases, contaminants, oxide of nitrogen and ozone.

b) Attack does occur, on exposure to alkaline solution and acids at very high temperatures.

c) Low expansion and hence excellent dimensional stability and thermal shock resistance.



Resistant to chemical attack

Virtually unaffected by sulphuric, nitric and hydrochloric acids. Hot alkalis and certain metal oxides react on silica. It is attacked by hydrofluoric acid. At high temperatures, it is also attacked by phosphoric acid.

Continuous use of fused silica above 1000°C leads to devitrification with formation of cristobalite which is a crystalline phase and will lead to breakage on repeated use. For accurate and long use, it is advisable to wash the articles in distilled water and alcohol to remove trace impurities.

Heating fused quartz to elevated temperatures causes SiO₂ to undergo dissociation. Consequently, when flame-working fused quartz, there is a brand of haze or smoke which forms just outside the intensely heated region. This haze presumably forms because the SiO₂ recombines with oxygen from the air (and perhaps water) and condenses as extremely small particles of amorphous SiO₂.

Co-efficient of expansion 0°C to 800°C

5.5 X 10⁻⁷ cm / cm / °C

Softening Point

1685°C

Annealing Point

1200°C

Strain Point

1120°C

Operating Temp

1050°C

Electrical resistiv

Please contact CT Enterprises for quotation.

Email: sales@ctenterprises.in | Phone: +91 8977721310

1002 - QUARTZ LOW FORM BEAKER

With Spout

- Beaker with Spout for Clean Pouring
- Dimensional accuracy
- Tough construction
- Durability

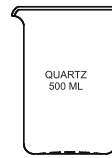

Product Code	Capacity ml	Approx O.D. x Length mm	Quantity Per Case	Price / Piece ₹
1002009	25	35 x 45	5	1895.00
1002012	50	40 x 58	5	2795.00
1002016	100	50 x 75	5	4300.00
1002018	150	55 x 88	5	5565.00
1002021	250	70 x 95	1	8310.00
1002024	500	85 x 115	1	15915.00
1002029	1000	105 x 145	1	27680.00

3164 - QUARTZ PETRI DISHES

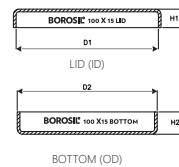

Product Code	Size mm	LID Approx I.D. (D1) x Height (H1) mm	Bottom Approx O.D. (D2) x Height (H2) mm	Quantity Per Case	Price / Piece ₹
3164077	100 x 17	103 x 15	100 x 17		18115.00

3175 - QUARTZ MUFFLE TRAYS

- Perfect finish
- Sturdiness
- Durability
- Holes: 2/4

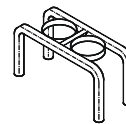

Product Code	Capacity ml	Approx O.D. x Length mm	Quantity Per Case	Price / Piece ₹
3175041	2 Holes	39	1	2500.00
3175042	4 Holes	76	1	4885.00

Quartz Ware



3185 - QUARTZ ROUND DISHES/BASINS With Spout

- Round with Spout
- Perfect finish
- Accurate dimensions
- Longer life span

Product Code	Approx O.D. x Height mm	Nominal Capacity ml	Quantity Per Case	Price / Piece ₹
3185008	55 x 23	20	10	1640.00
3185042	75 x 27	45	5	4640.00
3185044	85 x 35	70	5	5785.00
3185045	95 x 36	85	1	9585.00
3185016	100 x 38	100	1	11530.00
3185046	115 x 47	200	1	17535.00

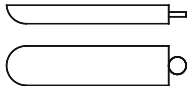

3186 - QUARTZ COMBUSTION BOATS With Handle

- Light in weight
- Longer life span
- Accurate dimensions
- Sturdiness

Product Code	Approx O.D. x Length mm	Quantity Per Case	Price / Piece ₹
3186Q01	12 x 77	1	1535.00

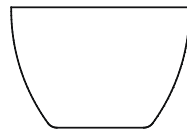

3190 - QUARTZ CRUCIBLES Without Lid

- Accurate dimensions
- Longer life span
- Fine finish
- Sturdiness

Product Code	Capacity ml	Approx O.D. x Length mm	Quantity Per Case	Price / Piece ₹
3190007	15	40 x 26	10	900.00
3190009	25	47 x 30	10	1315.00
3190012	50	57 x 35	10	2095.00
3190015	80	69 x 45	10	3375.00
3190018	150	80 x 54	5	6180.00

3191 - LIDS FOR QUARTZ CRUCIBLES (CAT. NO. 3190)

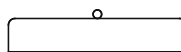

- Accurate dimension
- Longer life span
- Fine finish
- Sturdiness

Product Code	Capacity ml	Quantity Per Case	Price / Piece ₹
3191007	15	10	885.00
3191009	25	10	1260.00
3191012	50	10	1970.00
3191015	80	10	3255.00



3195, 3196 & 3197 - QUARTZ VOLATILE MATTER CRUCIBLES

- Dimensional accuracy
- Tough construction
- Durability
- Comes with Lid and Plunger

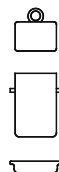

Product Code	Catalogue No.	Item	Dimension mm	Quantity Per Case	Price / Piece ₹
3195041	3195	Crucible	25 x 38	5	2530.00
3196041	3196	Plunger	12.5	5	830.00
3197041	3197	Lid		5	740.00

3198 - QUARTZ SILICA TRIANGLES on Nichrome (Translucent)

- Longer life span
- Sturdiness
- Seamless finish

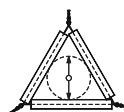

Product Code	Capacity ml	Quantity Per Case	Price / Piece ₹
3198007	15	10	330.00
3198009	25	10	435.00
3198012	50	10	830.00
3198015	80	5	1180.00



4984 - QUARTZ ERLLENMEYER (CONICAL) FLASK

- Suitable for digestion of samples with concentrated acid (except HF)
- Ideal for estimation of boron in soil
- Withstand sudden heating & cooling



Product Code	Capacity ml	External Dimension		Price / Piece ₹
		O.D. mm	Height mm	
4984016	100	64	105	8695.00
4984018	150	72	124	10695.00
4984021	250	85	140	13535.00



Quartz Ware

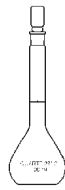

5644 - QUARTZ VOLUMETRIC FLASK

With I/C Quartz Stopper, Class B

- Dimensional accuracy
- Sturdiness
- Durability
- Perfect finish

Product Code	Capacity ml	Quantity Per Case	Price / Piece ₹
5644005	5	1	7290.00
5644006	10	1	4185.00
5644009	25	1	4950.00
5644012	50	1	5925.00
5644016	100	1	7655.00
5644021	250	1	11110.00
5644024	500	1	14790.00
5644029	1000	1	29540.00



8600 - QUARTZ CIRCULAR CAPSULE

- Suitable for determination of ash content in coal analysis
- Withstand sudden heating & cooling

Product Code	External Dimension		Price / Piece ₹
	Height mm	Diameter mm	
8600Q01	14	48	2095.00
8600Q02	15	54	2375.00

*The ash content in coal is an important parameter in determining the quality of coal. Ash reduces the calorific value of coals and hence burning coals on a large scale require knowledge of their ash content. Analysis is fairly straight forward, with the coal thoroughly burnt at 750°C to 800°C and the ash material express as a percentage of the original weight. It gives an indication about the quality of coal.

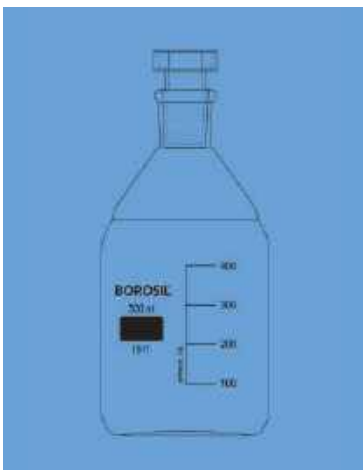

1511 - QUARTZ REAGENT BOTTLE

With Hollow Quartz I/C Stopper

Product Code	Capacity ml	Quantity Per Case	Price / Piece ₹
1511024	500	1	24065.00

3028 - QUARTZ MEASURING CYLINDER

With Spout, Class B

Product Code	Capacity ml	Quantity Per Case	Price / Piece ₹
3028005	5	1	9700.00
3028006	10	1	10870.00
3028009	25	1	14745.00
3028012	50	1	22505.00
3028016	100	1	30275.00
3028021	250	1	43470.00
3028024	500	1	59770.00

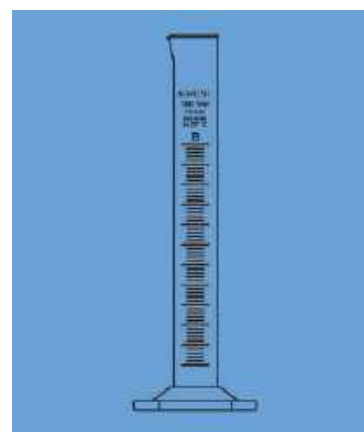

6141 - QUARTZ FILTER FUNNEL, 60°

Product Code	Capacity mm	Quantity Per Case	Price / Piece ₹
6141071	75	1	21285.00

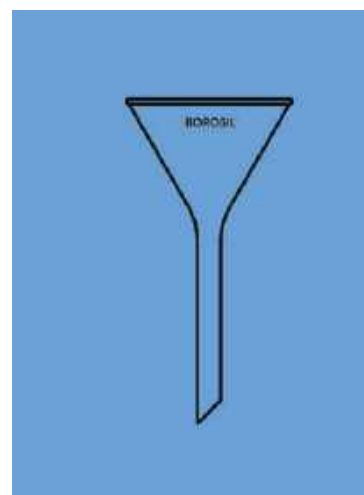

7064 - QUARTZ MOHR GRADUATED PIPETTES, CLASS B

Product Code	Capacity ml	Quantity Per Case	Price / Piece ₹
7064P41	1 x 0.01	1	12580.00
7064P22	2 x 0.1	1	8535.00
7064P55	5 x 0.1	1	11205.00
7064P06	10 x 0.1	1	13195.00

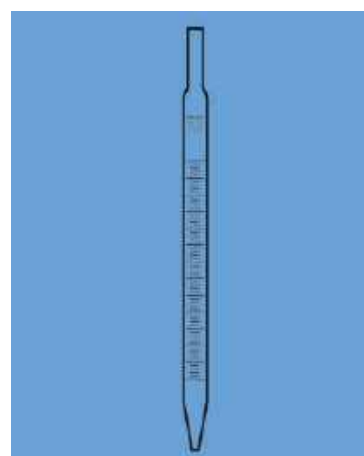

7104 - QUARTZ VOLUMETRIC PIPETTES, CLASS B

Product Code	Capacity ml	Quantity Per Case	Price / Piece ₹
7104001	1	1	9640.00
7104002	2	1	9640.00
7104003	3	1	12495.00
7104004	4	1	12495.00
7104005	5	1	12295.00
7104706	6	1	13830.00
7104006	10	1	13830.00

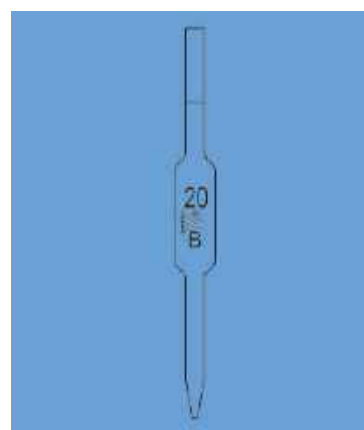

Quartz Ware

Silica Ware



Our high-purity Silica Ware offers exceptional resistance to acids, except hydrofluoric and phosphoric acids at high temperatures. It withstands extreme temperatures while maintaining excellent thermal stability and durability up to 1000°C. With minimal thermal expansion, it is ideal for demanding laboratory and industrial applications.

8900 - SILICA CRUCIBLE

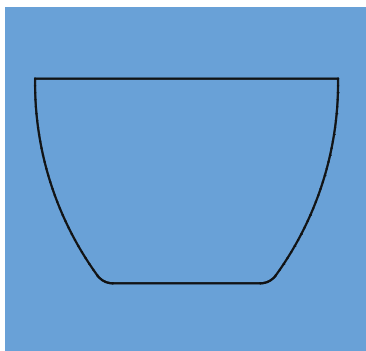

Product Code	Capacity ml	Quantity Per Case	Price / Piece ₹
8900007	15	10	680.00
8900009	25	10	740.00
8900012	50	10	1500.00
8900072	80	5	2720.00
8900016	100	5	3560.00
8900018	150	5	4400.00

8901 - SILICA CRUCIBLE LID ONLY

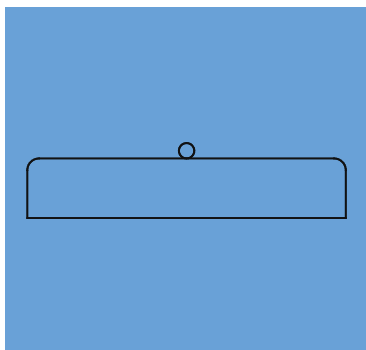

Product Code	Capacity ml	Quantity Per Case	Price / Piece ₹
8901007	15	10	840.00
8901009	25	10	896.00
8901012	50	10	1640.00
8901072	80	5	2960.00
8901016	100	5	3760.00
8901018	150	5	4800.00

8902 - SILICA BASIN WITH SPOUT, ROUND

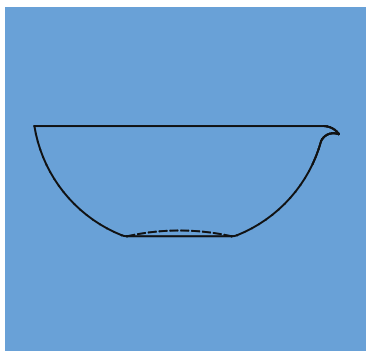

Product Code	Capacity ml	Quantity Per Case	Price / Piece ₹
8902008	20	10	1280.00
8902745	45	10	1920.00
8902770	70	5	2840.00
8902785	85	5	3920.00
8902016	100	5	4480.00

8903 - SILICA VOLATILE MATTER CRUCIBLE PLUNGER

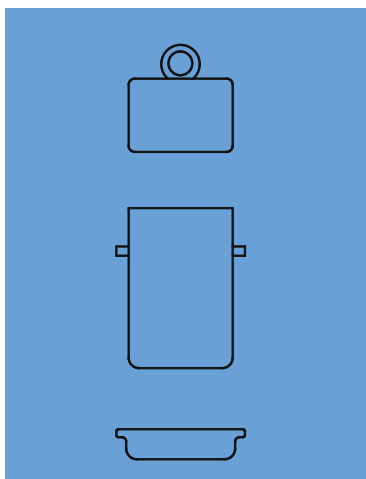

Product Code	Capacity ml	Quantity Per Case	Price / Piece ₹
8903001	Crucible	2	3200.00
8903002	Plunger	4	1200.00
8903003	Lid	4	1520.00



Flasks

For general laboratory applications

- Conforms to IS 1381 (Part I) ISO 1773
- Mechanically strong
- Uniform Wall Thickness
- Ideal for heating applications
- Shape suitable for mixing liquid
- Available in Wide neck / Screw Cap and Amber colour
- Ideal for culture work

Please contact CT Enterprises for quotation.

Email: sales@ctenterprises.in | Phone: +91 8977721310

Microscope Slides & Cover Glasses



Material

Made of sodalime glass with thickness of 1.0 - 1.2mm

Edges

Finely ground edges at 90deg angle which minimizes the risk of cuts when handling the slides

Surfaces

Slide surface is cleaned with water for the perfect smear preparations

Packaging

Packed in a paper box containing silica desiccant to absorb moisture
50 slides per box and 25 boxes per case

Types

Plain

For routine applications

Frosted

For easy labelling with marker

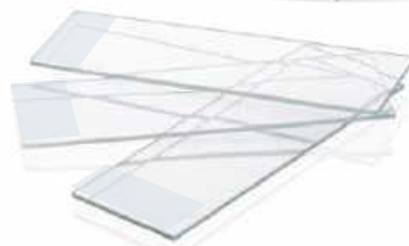

Please contact CT Enterprises for quotation.

Email: sales@ctenterprises.in | Phone: +91 8977721310

9100 - MICROSCOPE GLASS SLIDES

- Made from the finest white glass of uniform quality
- Conforms to IS 3099 ISO 8037 standard
- High- precision ground edges on all four sides
- Thin, flat and resistant to corrosion or fogging
- Pre-cleaned and ready to use
- Subjected to strict quality control checks, examined individually and environmentally controlled dry before packaging
- Specially designed for meeting the stringent needs of users
- Free from all visual defects
- Used for routine microscopy applications



Product Code	Description	Dimensions mm L x B x WT	Quantity Per Packet No.	Packets / Case	Price / Packet ₹
9100P02*	Plain, Ground Edges	76 x 26 x 1	50	25	130.00
9100D01	Double Frosted, Ground Edges	76 x 26 x 1	50	25	230.00

L : Length x B : Breadth x WT : Wall Thickness

* with BIS Certification

9115 - COVER GLASS

- Made from the finest white glass of uniform quality
- Available in both square and rectangular shape
- Cover glass is cut, cleaned, sorted and weighed
- Resistance to corrosion and fogging
- Free from ragged edges, oily film and finger prints
- Packed in reclosable plastic boxes for protection during storage
- Pre cleaned and ready to use
- Subjected to strict quality control checks, examined individually and environmentally controlled to dry before packaging

Product Code	Description	Dimensions mm	Quantity Per Packet / Piece	Packets / Case	Price / Packet ₹
9115S01	Square	18 x 18	100	50	350.00
9115S02	Square	22 x 22	100	50	520.00
9115S03	Square	24 x 24	100	50	590.00
9115R01	Rectangular	22 x 40	100	50	840.00
9115R02	Rectangular	22 x 50	100	50	975.00
9115R03	Rectangular	22 x 60	100	50	1135.00

9115S01 - SQUARE



9115S02 - SQUARE



9115S03 - SQUARE



9115R01 - RECTANGULAR



9115R02 - RECTANGULAR



9115R03 - RECTANGULAR



• Slides & Cover Glasses
• Lab Accessories & Silicon
• Vials
• Laboratory Filter Media
• Syringe Filter

Laboratory Accessories

For safer experiments

Tongs

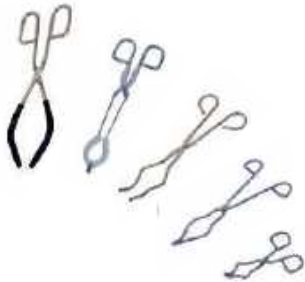

Clamp with PVC Coated Prong



Clamp



Clamp with Bosshead



Burette Clamp



Boss Head



Retort Ring & Test Tube Holder



Retort Base



Rod For Retort Base



Z Shape Test Tube Stand



Burner



Spatula



TONGS FOR BEAKERS & FLASKS

- Made of stainless steel
- Used to handle hot beakers & flasks
- Provided with silicon sleeves or in fibre glass yarn to resist direct flame

Product Code	Description	Size Inches	Case Lot No.	Price / Piece ₹
LATG8888B10	Beaker tong	10	6	450.00
LATG8888B12	Beaker tong	12	6	600.00
LATG8888F10	Flask tong	10	6	570.00
LATG8888F12	Flaks tong	12	6	710.00



TONGS FOR CRUCIBLE

- Made of Stainless Steel
- Used to handle hot crucibles

Product Code	Description	Size Inches	Case Lot No.	Price / Piece ₹
LACT8888006	Crucible tong with bow stainless steel	6	6	225.00
LACT8888008	Crucible tong with bow stainless steel	8	6	285.00
LACT8888010	Tong crucible, SS,	10	6	390.00
LACT8888012	Crucible tong with bow stainless steel	12	6	530.00



CLAMPS

- Available in Zinc & Aluminium diecasted
- It is coated with LEAD-FREE powder coating & fitted with brass screw which makes it totally RUST-FREE CLAMP
- Two & three finger clamp Jaws can be covered with PVC sleeves
- Two & four finger clamp has cork lined Jaws holds upto 90 mm articles
- It is provided with 8 mm diameter & 150 mm long Stainless Steel(Grade 201)rod

Product Code	Description	Case Lot No.	Price / Piece ₹
L AFC8888Z02	Two finger clamp, Zinc pressure die casted	10	450.00
L AFC8888AD3	Three finger clamp, Aluminum pressure die casted	10	530.00
L AFC8888ZD4	Four finger clamp, Zinc pressure die casted	10	450.00
L AFC8888AD4	Four finger clamp Aluminum pressure die casted	10	480.00





CLAMPS WITH BOSSHEAD

- Available in Zinc & Aluminium diecasted
- It is coated with LEAD-FREE powder coating & fitted with brass screw which makes it totally RUST-FREE CLAMP
- Two & three finger clamp Jaws can be covered with PVC sleeves
- Two & four finger clamp has cork lined Jaws holds upto 90 mm articles
- With adjustable bosshead attached clamp length can be vary, can be rotated 360° and locked at any angle

Product Code	Description	Case Lot No.	Price / Piece ₹
L AFC8888Z03	Two finger clamp (Zinc PDC) with adjustable bosshead	12	815.00
L AFC8888A03	Three finger clamp (Aluminium PDC) with adjustable bosshead	12	815.00
L AFC8888Z04	Four finger clamp (Zinc PDC) with adjustable bosshead	12	900.00
L AFC8888A04	Four finger clamp (Aluminium PDC) with adjustable bosshead	12	940.00



UNIVERSAL CLAMPS

- Single Burette / Test Tube Clamp made of stainless steel Jaws & Aluminium bosshead
- Round jaws are covered with PVC coating
- Opens from 15 mm to 45 mm in Diameter
- Clamps attaches to rods up to 13 mm in diameter. Threaded rod and wing nut adjust clamp angle and overall length from 13 cm to 15 cm

Product Code	Description	Case Lot No.	Price / Piece ₹
L ABC8888SC1	Single Burette clamp, PVC coated jaws stainless steel	12	600.00
L ABC8888S01	Single Burette clamp, PVC uncoated jaws, stainless steel	12	530.00

BURETTE CLAMPS

- Single / Double Burette clamp is made of Aluminium die casting
- Feature black PVC sleeves for firm gripping of burettes.
- This adjustable burette clamp is suitable for all burettes up to 100 ml which are held in place by the high pressure created by the springs yet allows easy operations without damaging the glassware

Product Code	Description	Case Lot No.	Price / Piece ₹
L ABC8888B01	Single burette clamp, Aluminium PDC Fig. A	6	900.00
L ABC8888A02	Double burette clamp, Aluminium PDC Fig. B	6	900.00
L ABC8888AE1	Single burette clamp, Aluminium PDC (Eco.) Fig. C	6	450.00
L ABC8888AE2	Double burette clamp, Aluminium PDC (Eco.) Fig. D	6	600.00

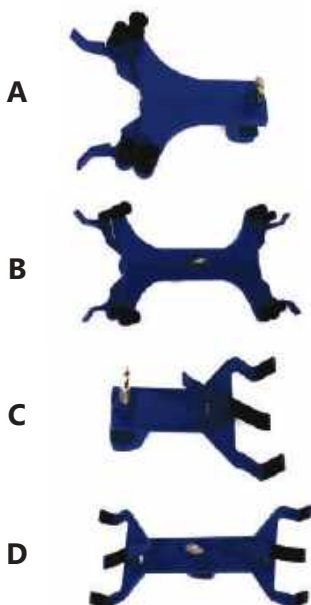

BOSSHEADS

- Bosshead made of Zinc & Aluminum pressure die casted
- It can hold a rod upto 16 mm diameter at 90° angle and Swivel bosshead rotate at 360° angle
- It is coated with LEAD-FREE powder coating & fitted with Nickel plated thumb screw

Product Code	Description	Case Lot No.	Price / Piece ₹
LABH8888RBL	Regular bosshead Zinc PDC Fig. A	12	225.00
LABH8888OBL	Round bosshead Zinc PDC Fig. B	12	285.00
LABH8888JBL	Jumbo bosshead Aluminum PDC Fig. C	12	600.00
LABH8888SBL	Swivel bosshead Zinc PDC Fig. D	12	400.00

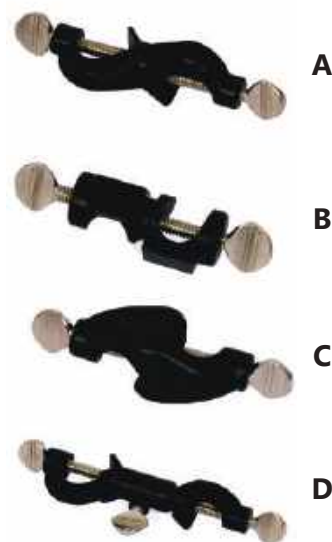

RETORT RING

- Strong circular mild steel ring with 6 mm diameter stem
- Open bosshead fitted with thumb screw to accept rods from 8 mm to 15 mm diameter

Product Code	Description	Size in Inches	Case Lot No.	Price / Piece ₹
LARR8888003	Retort Ring with bosshead	3	6	370.00
LARR8888004	Retort Ring with bosshead	4	6	465.00



RETORT BASE

- Superior Heavy duty steel alloy stand with rubber lining on a shorter side gives extra stability
- With lead-free powder coating

Product Code	Description	Size Inches	Case Lot No.	Price / Piece ₹
LARB8888H06	Retort base, Heavy	6" x 4"	6	815.00
LARB8888H08	Retort base, Heavy	8" x 5"	6	970.00
LARB8888H10	Retort base, Heavy	10" x 6"	6	1640.00



ROD FOR RETORT BASE

- With stainless steel Grade 201

Product Code	Description	Approx O.D. x Height mm	Case Lot No.	Price / Piece ₹
LARS8888500	Retort Rod (SS Grade 201)	12 x 500	2	570.00
LARS8888600	Retort Rod (SS Grade 201)	12 x 600	2	695.00
LARS8888750	Retort Rod (SS Grade 201)	12 x 750	2	795.00





TEST TUBE STAND

- It is made of Aluminum sheet, Z type, new design, single piece fabrication
- One row of holes of 30 mm diameter, the second row of holes of 25 mm diameter and third row of hole of 16 mm diameter
- This aluminium Z shape design is Coated with lead free powder coating make it corrosion resistant

Product Code	Description	Case Lot No.	Price / Piece ₹
LATS8888H19	Z' Shape Test Tube Stand, Aluminum, 19 hole assorted	6	600.00
LATS8888H25	'Z' Shape Test tube stand, 25 hole for 16mm tube	6	600.00



TEST TUBE HOLDER

- A pair of spring strip of hard rolled stainless steel, mounted in wooden handle in cross-scissor shape, and accepts tubes of diameter 12-43 mm.
- Overall length about 225mm

Product Code	Description	Case Lot No.	Price / Piece ₹
LATH8888000	Test tube holder, cross pattern, Stainless steel	24	255.00



BURNERS

- Bunsen Burner 13mm/11mm ideal for use with natural gas and L.P.G.
- Nickel-plated brass burner tube with Rotatable air regulator
- Enamelled Zinc pressure die casted base
- Base diameter 80 mm

Product Code	Description	Case Lot No.	Price / Piece ₹
LABR8888Z11	Bunsen burner, Zinc PDC base with 11 mm brass pipe for L.P.G. Fig. A	2	1125.00
LABR8888Z13	Bunsen burner, Zinc PDC base with 13 mm brass pipe for L.P.G. Fig. B	2	1125.00
LABR8888013	Burner, sheet metal base with 13 mm pipe, for L.P.G. Fig. C	2	900.00

SPATULAS

- Made of stainless steel grade 202
- Spatulas are used for measuring solids moving objects and scraping material out of beakers

Product Code	Description	Size in Inches	Case Lot No.	Price / Piece ₹
LACS8888006	Chattaway Spatula	6	20	95.00
LACS8888008	Chattaway Spatula	8	20	105.00
LASL8888C08	Micro Chattaway Spatula	8	20	100.00
LASC8888M06	Micro Scoop	6	10	85.00
LASC8888SM6	Semi Micro Spatula	6	10	120.00
LASL8888075	Big Spoon Spatula	7.5	10	180.00
LASL8888009	Big Spoon Spatula	9	10	195.00
LASP8888B06	Both side flat	6	20	100.00
LASP8888B08	Both side flat	8	20	130.00
LASP8888004	One end flat and one end Spoon	4	50	80.00
LASP8888006	One end flat and one end Spoon	6	50	85.00
LASP8888008	One end flat and one end Spoon	8	50	120.00
LASP8888010	One end flat and one end Spoon	10	50	185.00
LASP8888012	One end flat and one end Spoon	12	50	215.00
LASO8888W04	Ointment Spatula	4	10	225.00
LASO8888W06	Ointment Spatula Wooden Handle	6	10	245.00
LATG8888S06	Ointment Spatula Forged Stainless Steel	6	10	490.00
LASL8888P06	Pointer Spatula	6	10	130.00
LASC8888165	165 mm Scoop	6.5	10	120.00
LASL8888510	Big Spoon Spatula	10	10	340.00



* For products listed on the above table use HSN code 90189022



FORCEPS POINTED

Product Code	Description	Case Lot No.	Price / Piece ₹
LAFP8888004	Forceps, Pointed dissecting, 4"	10	135.00
LAFP8888005	Forceps, Pointed dissecting, 5"	10	190.00
LAFP8888006	Forceps, Pointed dissecting, 6"	10	225.00



FORCEPS, PTFE COATED POINTED

Product Code	Description	Case Lot No.	Price / Piece ₹
LAFPP8888004	Forceps, PTFE, Coated Pointed end, 4"	10	1955.00
LAFPP8888006	Forceps, PTFE, Coated Pointed end, 6"	10	2520.00



FORCEPS BLUNT DISSECTING

Product Code	Description	Case Lot No.	Price / Piece ₹
LAFB8888005	Forceps, Blunt dissecting, 5"	10	205.00
LAFB8888006	Forceps, Blunt dissecting, 6"	10	215.00
LAFB8888008	Forceps, Blunt dissecting, 8"	10	300.00



FORCEPS, PTFE COATED BLUNT

Product Code	Description	Case Lot No.	Price / Piece ₹
LAFBP8888004	Forceps, PTFE, Coated Blunt end, 4"	10	1955.00
LAFBP8888006	Forceps, PTFE, Coated Blunt end, 6"	10	2520.00



WIRE GAUGE

Product Code	Description	Case Lot No.	Price / Piece ₹
LAWG8888C05	Wire Gauge with Ceramic center 5" x 5"	10	130.00
LAWG8888C06	Wire Gauge with Ceramic center 6" x 6"	10	170.00



TRIANGULAR TRIPOD

Product Code	Description	Case Lot No.	Price / Piece ₹
LATT8888200	Triangular Tripod, SS, 200 x 125 mm	2	790.00

Our high-performance Silicone Lab accessories are designed for precision and durability, offering excellent heat resistance (-40°C to 220°C), superior tensile strength, and flexibility. Manufactured using premium-grade silicone, these products ensure exceptional chemical stability, making them ideal for critical laboratory and industrial applications.

SILICONE CORK/STOPPER

Product Code	Cork Number	Bottom (mm)	Top (mm)	Height (mm)	Quantity Per Case	Price / Piece ₹
LASC8888005	5	5	7	16	10	21.00
LASC8888008	8	8	10.5	20	10	24.00
LASC8888009	9	9	11.5	20	10	33.00
LASC8888010	10	10	12.5	20	10	36.00
LASC8888011	11	11	14	24	10	56.00
LASC8888013	13	13	16	24	10	66.00
LASC8888015	15	15	18	24	10	88.00
LASC8888017	17	17	20.5	26	10	110.00
LASC8888018	18	18	21	26	10	118.00
LASC8888019	19	19	22.5	28	10	140.00
LASC8888021	21	21	24.5	28	10	182.00
LASC8888023	23	23	26.5	28	10	202.00
LASC8888025	25	25	28.5	28	5	238.00
LASC8888027	27	27	31	32	5	292.00
LASC8888029	29	29	31	32	5	376.00
LASC8888031	31	31	36	35	5	474.00
LASC8888033	33	33	38.5	38.5	5	606.00
LASC8888035	35	35	45.5	36.5	5	732.00
LASC8888038	38	38	42.5	40.5	5	870.00
LASC8888040	40	40	49.5	40.5	5	868.00



SILICONE TURNOVER FLANGE SEPTA, FOR TEST TUBE, NON SERRATEDS

Product Code	Size	Quantity Per Case	Price / Piece ₹
LASST8888012NS	12 mm	10	84.00
LASST8888015NS	15 mm	10	104.00
LASST8888018NS	18 mm	5	146.00
LASST8888022NS	22 mm	5	188.00





SILICONE TURNOVER FLANGE SEPTA, FOR SOCKET, NON SERRATED

Product Code	Size	Quantity Per Case	Price / Piece ₹
LASSS8888012NS	S - 14	10	140.00
LASSS8888019NS	S - 19	10	216.00
LASSS8888024NS	S - 24	5	252.00
LASSS8888029NS	S - 29	5	398.00



SILICONE SLEEVE, FOR CRUCIBLE

Size	Bottom (mm)	Top (mm)	Height (mm)	Wall Thickness (mm)
1	11	22	20	2.5
2	22.5	28	20	2.5
3	23.5	36.5	25	3
4	28	46	30.5	3
5	38	56	35	3.5
6	47	68	41	4
7	57	81	43.5	5

Product Code	Product Description	Quantity Per Case	Price / Set ₹
LASSC8888001	Sleeve for Crucible set	Set of 7 sleeves	2090.00



SILICONE FILTRATION CONE

Product Code	For Filtration flasks Capacity (ml)	Quantity Per Case	Price / Piece ₹
LASFC8888024	250/500	10	710.00
LASFC8888030	1000/2000	10	1255.00
LASFC8888033	5000	5	1610.00
LASFC8888038	10000	2	2175.00

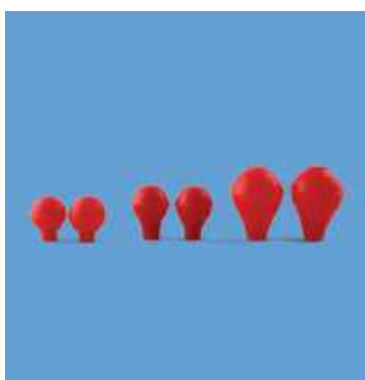

SILICONE PIPETTE FILLER BULBS

Product Code	Sizes	Capacity	Quantity Per Case	Price / Piece ₹
LASPFB888800S	Small	5 ml	10	104.00
LASPFB888800M	Medium	10 ml	10	140.00
LASPFB888800L	Large	15 ml	10	174.00
LASPFB888800EL	Extra Large	20 ml	10	210.00
LASPFB888800V	Oval	25 ml	10	348.00
LASPFB888800SL	Super Large	50 ml	5	765.00
LASPFB888800ESL	Extra Super Large	100 ml	5	975.00

SILICONE TEATS

Product Code	Capacity ml	Quantity Per Case	Price / Piece ₹
LAST8888001	1	20	56.00
LAST8888003	2 & 3	10	58.00



SILICONE PIPETTE FILLER, WITH VALVES

Product Code	Quantity Per Case	Price / Piece ₹
LASPFV8888001	5	800.00



SILICONE HAND PROTECTORS

Product Code	Product Description	Quantity Per Case	Price / Piece ₹
LASHP8888001	Hand grip (hand protector)	2	1395.00



SILICONE FLASK STAND

Product Code	Product Description	Quantity Per Case	Price / Piece ₹
LASFS8888001	Universal	2	4525.00

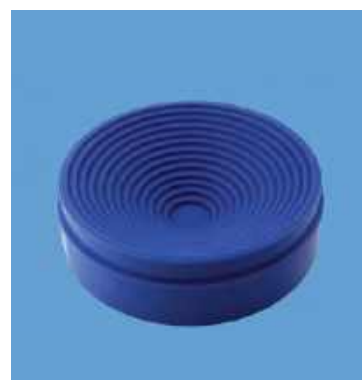

SILICONE SHEET

Product Code	Product Description	Quantity Per Case	Price / Piece ₹
LASS8888001	12"x12", Mats	2	8355.00
LASS8888002	9.5"x9.5" x 2.7mm, Sheet	2	1740.00

BOROSIL[®] Scientific

Analytical Vials & Closures

“for Labs where
compliance matters”

- 2ml HPLC VIALS/CLOSURES/KIT
- 20ml HEADSPACE GC VIALS/CLOSURES/KIT
- Certified Pre-assembled EPA/TOC VIALS/KIT

Why should I choose BOROSIL vials?

No matter which make of instrument you use, it is critical that your sample is carried in a reliable vial.

Whereas, it is important that vials are made within stringent dimensions in controlled conditions to perform consistently, it is even more critical to a Chemist to be able to confidently rule out the vial as a contributor to an OOS (out of specification) incident.

BOROSIL being a manufacturer of vials, provides a Chemist access to the detailed testing & quality documentation of vials thereby enabling a chemist to investigate root causes effectively.

Borosil vials are manufactured in **ISO 15378 (GMP) Certified Plant Under Controlled Conditions Online camera for 100% DIMENSIONAL INSPECTION Class 8 Clean Room packaging to avoid the RISK OF CONTAMINATION**



Please contact CT Enterprises for quotation.

Email: sales@ctenterprises.in | Phone: +91 8977721310

Quality Assurance



Vial forming Process

On automated machines for utmost consistency

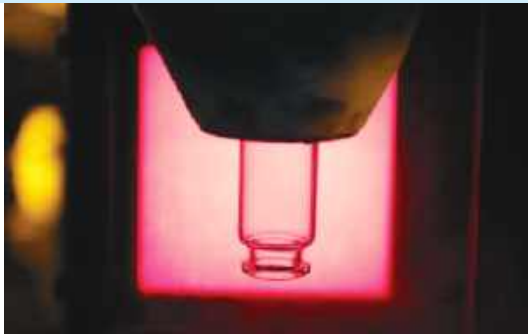

Dimensional Inspection

Online optical inspection to minimize ensure 100% dimensional and cosmetic conformance

Annealing Process

Imparts mechanical strength to the vial

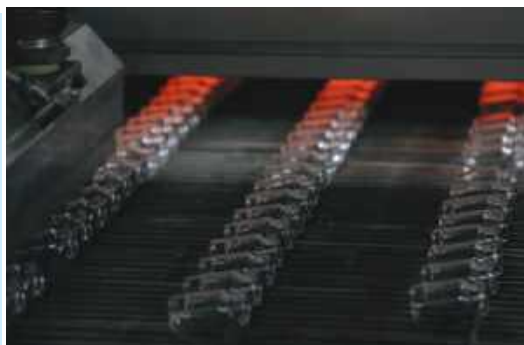

Final Inspection and packing

Packed in ISO Certified Class 8 Clean Room facility with minimum human intervention

Please contact CT Enterprises for quotation.

Email: sales@ctenterprises.in | Phone: +91 8977721310

Borosil certified Vials are manufactured in an ISO 9001 certified facility, in accordance with US and European Pharmacopoeia.

Easy ordering!!!

The 14 Digit Code

Whether you choose to buy a combipack that includes **Vials** and matching **Closures** or only the glass vial or only the vial closure, **BOROSIL's 14 digit code** makes it very easy in **FOUR** simple steps!

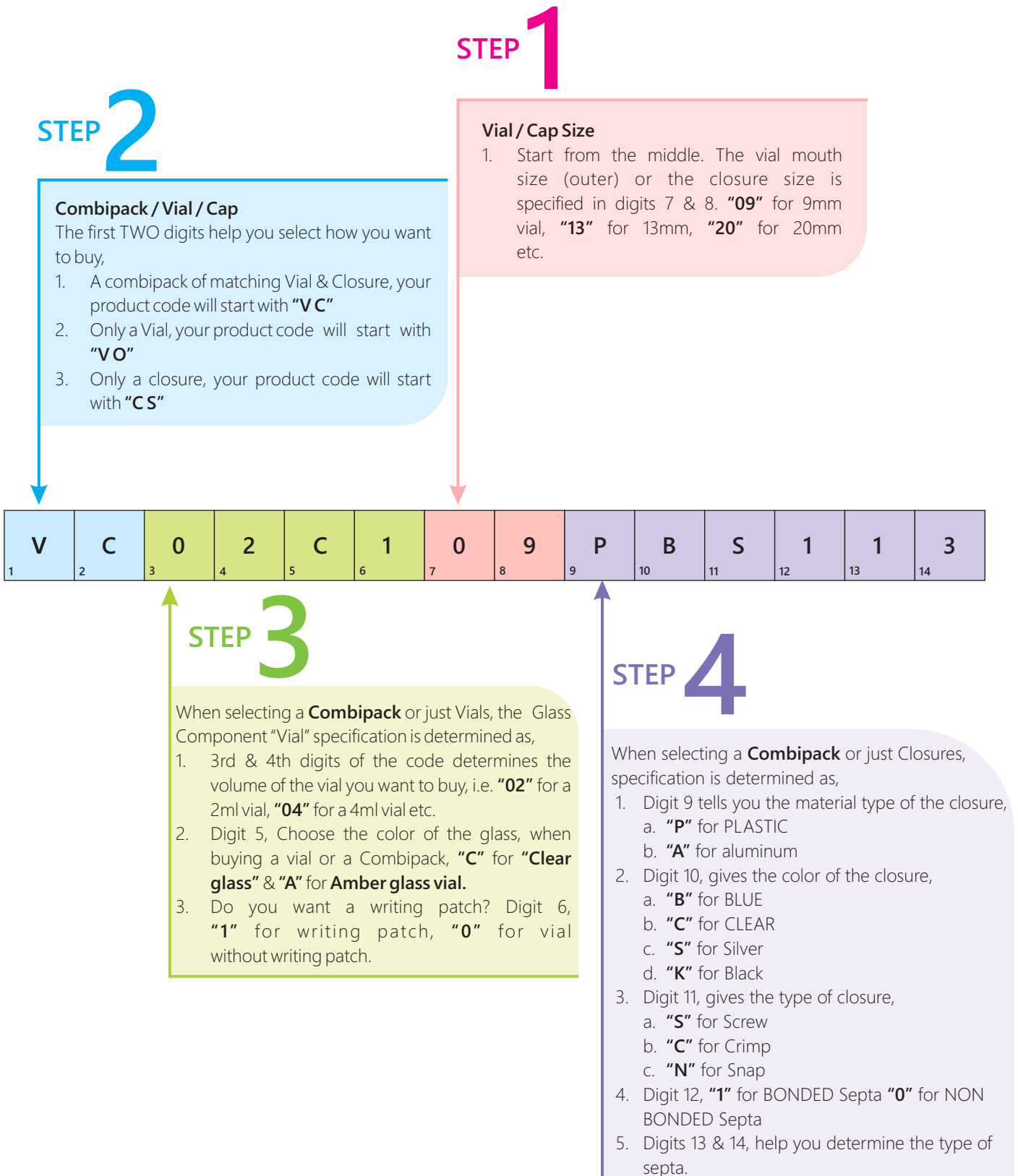

2ml HPLC SAMPLE VIALS & CLOSURES



Glass vials with closures (COMBIPACK)

Product Code	Neck Dia	Septa Feature 1	Graduation with write on patch	Septa Feature 2	Pack Size	Case Lot	List Price Per Pack ₹
9mm Screw Top Clear Vials made from Borosilicate USP Type I 49-Expansion glass with Closure							
Blue PP Cap PTFE-Silicone Septa							
VC02C009PBS124	9mm	Non Slit	NO	Bonded	100	10 X 100	2700.00
VC02C009PBS114	9mm	Pre Slit	NO	Bonded	100	10 X 100	2700.00
VC02C109PBS124	9mm	Non Slit	YES	Bonded	100	10 X 100	2950.00
VC02C109PBS114	9mm	Pre Slit	YES	Bonded	100	10 X 100	2950.00
VC02C109PBS113	9mm	Pre Slit	YES	Bonded	100	10 X 100	3600.00
9mm Screw Top AMBER Vials made from Borosilicate USP Type I 54-Expansion glass with Closure							
Blue PP Cap PTFE-Silicone Septa							
VC02A009PBS124	9mm	Non Slit	NO	Bonded	100	10 X 100	3150.00
VC02A009PBS114	9mm	Pre Slit	NO	Bonded	100	10 X 100	3150.00
VC02A109PBS124	9mm	Non Slit	YES	Bonded	100	10 X 100	3400.00
VC02A109PBS114	9mm	Pre Slit	YES	Bonded	100	10 X 100	3500.00
VC02A109PBS113	9mm	Pre Slit	YES	Bonded	100	10 X 100	4100.00
11mm Crimp Top Clear Vials made from Borosilicate USP Type I 49-Expansion glass with Closure							
Silver Aluminium Crimp PTFE-Silicone Septa							
VC02C011ASC021	11mm	Non Slit	NO	Non Bonded	100	10 X 100	2200.00
VC02C011ASC022	11mm	Pre Slit	NO	Non Bonded	100	10 X 100	2400.00
VC02C111ASC021	11mm	Non Slit	YES	Non Bonded	100	10 X 100	2300.00
VC02C111ASC022	11mm	Pre Slit	YES	Non Bonded	100	10 X 100	2500.00
11mm Crimp Top AMBER Vials made from Borosilicate USP Type I 54-Expansion glass with Closure							
Silver Aluminium Crimp PTFE-Silicone Septa							
VC02A011ASC021	11mm	Non Slit	NO	Non Bonded	100	10 X 100	2300.00
VC02A011ASC022	11mm	Pre Slit	NO	Non Bonded	100	10 X 100	2500.00
VC02A111ASC021	11mm	Non Slit	YES	Non Bonded	100	10 X 100	2600.00
VC02A111ASC022	11mm	Pre Slit	YES	Non Bonded	100	10 X 100	2750.00

2ml HPLC SAMPLE VIALS & CLOSURES

Borosilicate USP Type I, 49-Expansion glass vial with Silicone white/PTFE red septa



- 100 % Dimensionally **INSPECTED** & mechanically **STABLE** vial
- **LOW VOLATILE ORGANIC CARBON** containing PTFE-Silicone septa
- Suitable for **ROUTINE** analysis
- **EASY CAPPING** of vial



SCREW NECK



Glass vials with closures (COMBIPACK)

Product Code	Neck Dia	Septa Feature 1	Graduation with write on patch	Septa Feature 2	Pack Size	Case Lot	List Price Per Pack ₹
9mm Screw Top Clear Vials made from Borosilicate USP Type I, 49-Expansion glass with Closure Blue PP Cap PTFE-Silicone Septa							
VC02C009PBS125	9mm	Non Slit	NO	Non Bonded	100	10 X 100	2300.00
VC02C109PBS125	9mm	Non Slit	YES	Non Bonded	100	10 X 100	2550.00
9mm Screw Top AMBER Vials made from Borosilicate USP Type I 54-Expansion glass with Closure Blue PP Cap PTFE-Silicone Septa							
VC02A009PBS125	9mm	Non Slit	NO	Non Bonded	100	10 X 100	2750.00
VC02A109PBS125	9mm	Non Slit	YES	Non Bonded	100	10 X 100	3000.00

2ml HPLC SAMPLE VIALS & CLOSURES

Borosilicate USP Type I, 49-Expansion glass vial with Silicone white/PTFE red sept



- Excellent **SEALING** and **CHEMICAL RESISTANCE** glass vials
- Snap ring caps are **MORE CONVENIENT** in handling (Pushing on/removal)
- **COMPATIBLE** with all make LC/GC analysis
- **EASY CAPPING** of vial



Snap Top Vial



Glass vials with closures (COMBIPACK)

Product Code	Neck Dia	Septa Feature 1	Graduation with write on patch	Septa Feature 2	Pack Size	Case Lot	List Price Per Pack ₹
9mm Snap Top Clear Vials made from Borosilicate USP Type I 49-Expansion glass with Snap Top Closure Blue PP Cap PTFE-Silicone Septa							
VC02C011PNS011	11 mm	Non Slit	NO	Non Bonded	100	10 X 100	2200.00
VC02C111PNS011	11 mm	Non Slit	YES	Non Bonded	100	10 X 100	2300.00
9mm Snap Top AMBER Vials made from Borosilicate USP Type I 54-Expansion glass with Snap Top Closure Blue PP Cap PTFE-Silicone Septa							
VC02A011PNS011	11 mm	Non Slit	NO	Non Bonded	100	10 X 100	2300.00
VC02A111PNS011	11 mm	Non Slit	YES	Non Bonded	100	10 X 100	2600.00

9mm Snap Top Clear Vials made from Borosilicate USP Type I 33-Expansion glass with Snap top Closure Blue PP Cap PTFE-Silicon Septa

Product Code	Neck Dia	Septa Feature 1	Graduation with write on patch	Septa Feature 2	Pack Size	Case Lot	List Price Per Pack ₹
VC02C411PNS011	11 mm	Non Slit	YES	Non Bonded	100	10 X 100	2600.00

2ml HPLC CERTIFIED CLEAR VIALS & CLOSURES

Borosilicate USP Type I, ASTM Class A 33-Expansion glass vial with ultra pure certified septa

- 3.3-Expansion Borosilicate Type I glass vial with **HIGH SILICON, LOW ALKALI** content (SiO₂ 81%, Na₂O 3-3.5%)
- Leak proof Ultra pure certified **CHEMICALLY INERT** PTFE-Silicone septa
- **CHEMICALLY HIGHLY RESISTANT** glass vial
- **SPECIAL APPLICATIONS** in the pharmaceutical industries



Glass vials with closures (COMBIPACK)

Product Code	Neck Dia	Septa Feature 1	Graduation with write on patch	Septa Feature 2	Pack Size	Case Lot	List Price Per Pack ₹
9mm Screw Top Clear Vials made from Borosilicate USP Type I, ASTM Class A 33-Expansion glass with Closure Blue PP Cap Ultra Pure Certified PTFE-Silicone Septa							
VC02C409PBSUM1	9mm	Pre Slit	YES	Bonded	100	10 X 100	5400.00
VC02C409PBSUM2	9mm	Non Slit	YES	Bonded	100	10 X 100	5400.00
9mm Screw Top Clear Vials made from Borosilicate USP Type I, ASTM Class A 33-Expansion glass with Closure Blue PP Cap High Purity PTFE-Silicone Septa							
VC02C409PBS113	9mm	Pre Slit	YES	Bonded	100	10 X 100	4600.00

Note: Amber vials are available in USP Type I54 - Expansion Glass with above septa combination - prices on request.

Extractable study of vials and septa using LCMS-MS and GCMS Techniques

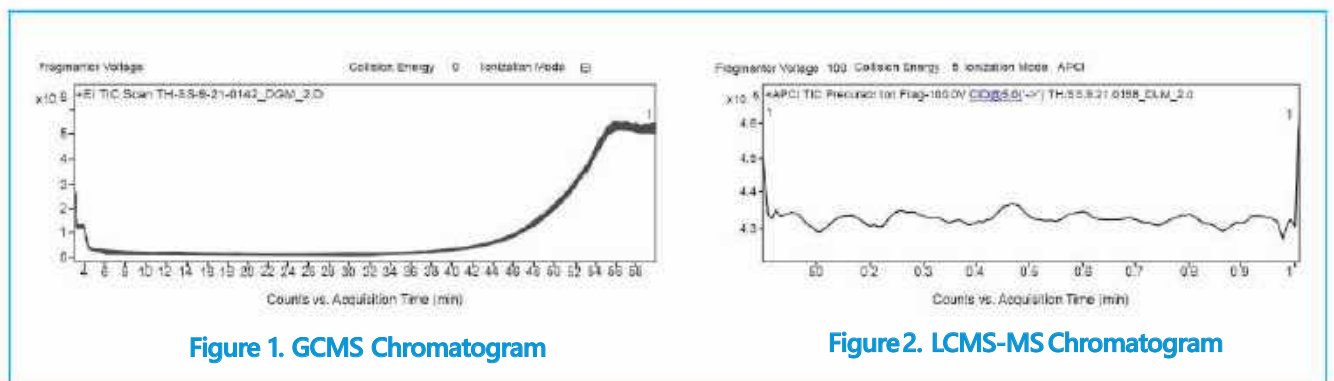

Figure 1. GCMS Chromatogram

Figure 2. LCMS-MS Chromatogram

NO EXTRANEOUS PEAK observed during chromatographic testing of vial & septa

2 ml HPLC TREATED VIALS & CLOSURES

Borosilicate USP Type I, ASTM Class A TREATED 33-Expansion glass vial with ultra pure certified septa



- Treated 33-Expansion Borosilicate Type I glass vial with **HIGH SILICON, LOWEST ALKALI** content
- Reduced the **RISK OF LEACHING** from glass vials
- **CHEMICALLY INERT** glass vial
- Leaf proof ultra pure certified **CHEMICALLY INERT** PTFE-Silicone septa



Glass vials with closures (COMBIPACK)

Product Code	Neck Dia	Septa Feature 1	Graduation with write on patch	Septa Feature 2	Pack Size	Case Lot	List Price Per Pack ₹
9mm Screw Top Clear Vials made from Borosilicate USP Type I, ASTM Class A Treated 33-Expansion glass with Closure Blue PP Cap Ultra Pure Certified PTFE-Silicone Septa							
VC02C409PBSUM1T	9mm	Pre Slit	NO	Bonded	100	10 X 100	6000.00
VC02C409PBSUM2T	9mm	Non Slit	YES	Bonded	100	10 X 100	6000.00

Extractables study of vials and septa using LCMS-MS and GCMS techniques

Lowest leaching characteristics glass vials

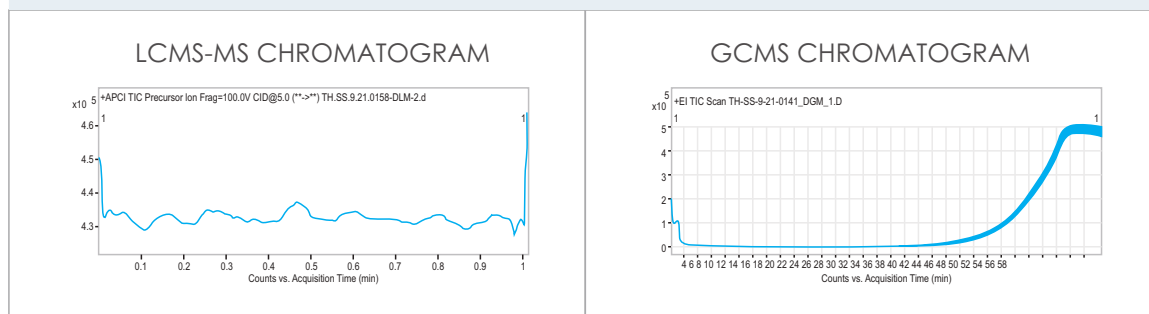

Lowest leaching characteristics septa

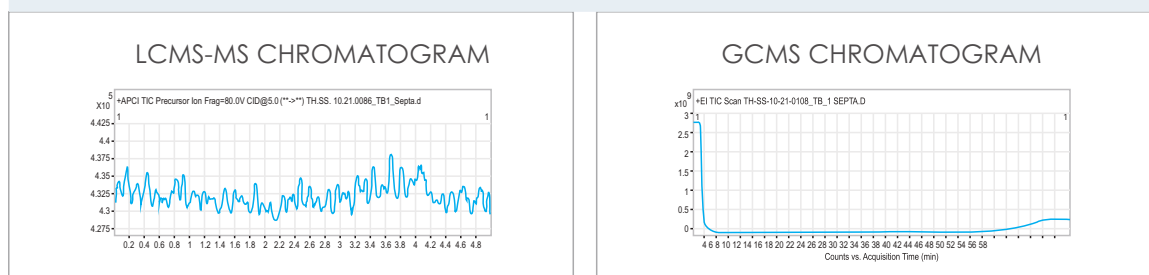

20 ml HEADSPACE GC VIALS & CLOSURES



Glass vials with closures (COMBIPACK)

Product Code	Neck Dia	Septa Feature 1	Graduation with write on patch	Septa Feature 2	Pack Size	Case Lot	List Price Per Pack ₹
20mm Crimp Top Clear Vials made from Borosilicate USP Type I 49-Expansion glass with Closure Silver Aluminium Crimp PTFE-Silicone Septa							
VC20R120ASC041	20mm	Non Slit	YES	Assembled	100	5 X 100	7650.00
VC20F120ASC041	20mm	Non Slit	YES	Assembled	100	5 X 100	7650.00

Only Glass Vials

Clear Vials made from Borosilicate USPTYPE I glass

Product Code	Volume	Vial Colour	Graduation with write on patch	Neck Dia	Neck Type	Glass Detail	Special Feature 1	Pack Size	Case Lot	List Price Per Pack ₹
VO02C00900S000	2ml	Clear	NO	9mm	Screw	49 Expansion	—	100	10 X 100	1300.00
VO02A00900S000	2ml	Amber	NO	9mm	Screw	54 Expansion	—	100	10 X 100	1700.00
VO02C10900S000	2ml	Clear	YES	9mm	Screw	49 Expansion		100	10 X 100	1550.00
VO02A10900S000	2ml	Amber	YES	9mm	Screw	54 Expansion		100	10 X 100	2100.00
VO02C01100C000	2ml	Clear	NO	11mm	Crimp	49 Expansion		100	10 X 100	1150.00
VO02A01100C000	2ml	Amber	NO	11mm	Crimp	54 Expansion		100	10 X 100	1350.00
VO02C11100C000	2ml	Clear	YES	11mm	Crimp	49 Expansion		100	10 X 100	1250.00
VO02A11100C000	2ml	Amber	YES	11mm	Crimp	54 Expansion		100	10 X 100	1650.00
VO20R12000C000	20ml	Clear	YES	20mm	Crimp	49 Expansion	Round Bottom	100	5 X 100	3500.00
VO20F12000C000	20ml	Clear	YES	20mm	Crimp	49 Expansion	Flat Bottom	100	5 X 100	3500.00
VO06CF2000C000	6ml	Clear	NO	20mm	Crimp	49 Expansion	Flat Bottom	172	1 X 172	On request
VO06AF2000C000	6ml	Amber	NO	20mm	Crimp	54 Expansion	Flat Bottom	172	1 X 172	On request

*Only Closures are available on request. MOQ 500 PKTS

40 ml EPA / TOC COMBIPACK



Glass vials with closures (COMBIPACK)

Product Code	Neck Dia	Vial Colour	Septa Feature 1	Graduation with write on patch	Neck Dia	Special Feature 2	Pack Size	Case Lot	List Price Per Pack ₹
24mm Screw Top Clear Vials made from Borosilicate USP Type I with Closure White PP Cap Open Top Certified Bonded PTFE-Silicone Septa									
VC40C124POS111	24mm	Clear	Non Slit	YES	Silicone PTFE	Non Bonded	72	1 X 72	15400.00
VC40A124POS111	24mm	Amber	Non Slit	YES	Silicone PTFE	Non Bonded	72	1 X 72	On Request

SAMPLING & STORAGE VIALS



Product Code	Capacity ml	Approx Mouth ID in mm	Dimension O.D. x Length in mm	Case Lot (MOQ)	Price Per Piece ₹
9913003	3	10	16 x 36	1200	35.00
9913005	5	10	16 x 55	900	40.00
9913006	10	16.5	24 x 50	1050	65.00
9913007	15	16.5	24 x 58	900	70.00
9913008	20	16.5	24 x 70	750	85.00
9913010	30	16.5	24 x 95	600	100.00

* For details refer page no. 198

BOROSIL[®] Scientific Laboratory Filter Media

for Accurate Analysis and Consistent Results



Laboratory
Filter Media

Please contact CT Enterprises for quotation.

Email: sales@ctenterprises.in | Phone: +91 8977721310

- QUALITATIVE FILTER PAPERS
- ASHLESS QUANTITATIVE FILTER PAPERS
- HARDENDED ASHLESS FILTER PAPERS
- GLASS FIBRE FILTER PAPERS
- CELLULOSE AND GLASS FIBRE THIMBLES

Borosil Filter Papers are made in collaboration with Hahnemühle - the pioneers in speciality papers since 1883!

The papers contain upto 98% alpha cellulose, the most stable form of cellulose in paper pulp, hence making the papers highly stable and durable. To ensure batch to batch uniformity and consistency in filtering performance, no recycled materials are used in the manufacturing processes. Very low ash content (Lowest value 0.004%) aid the laboratory professionals in accurate quantitative analysis with minimal errors. Made in Germany, the manufacturing processes and product specifications are compliant to the stringent European QC standards, guaranteeing the users finest quality filter papers.



Please contact CT Enterprises for quotation.
Email: sales@ctenterprises.in | Phone: +91 8977721310

Laboratory
Filter Media

BOROSIL[®] Scientific Laboratory Filter Media

Qualitative Filter Papers

Highly pure filter paper
recommended for qualitative analysis in laboratories.



Laboratory
Filter Media

In technical collaboration with
 **Hahnemühle** 
Life Science

Please contact CT Enterprises for quotation.

Email: sales@ctenterprises.in | Phone: +91 8977721310

Qualitative Filter Papers

High Purity Qualitative filter papers for routine laboratory filtration

- Filter papers for precise identification of materials and for sample preparation prior to sensitive detection method
- Made of refined cotton linters and cellulose
- Filter papers having >98% alpha cellulose, thereby ensuring highest stability and higher durability

Applications

- Recommended for precise identification of materials and for sample preparation prior to sensitive detection methods.
- Particle separation in Juices, Wine and other beverages production
- Qualitative analysis of milk and milk products.
- Sample preparation for water analysis
- Qualitative analysis of soil, fertilizer, animal feed

Technical Data

Grade	Sample	Speed	Retention rate [µm]	Filtration Herzberg (s)	Thickness (mm)	Weight [g/m ²]
B59501	Medium fine precipitates	Medium fast, thin	4 – 7	160	0.15	68
B59702	Medium-fine, crystalline precipitates	Medium fast	4 – 7	155	0.18	85
B59303	Fine precipitates	Medium slow	2 – 5	450	0.17	84
B60404	Coarse precipitates	Fast	12 – 25	50	0.19	79

* Approximate values,

** Measured with 100mm water column instead of 50 mm

● APPLICATIONS ●



Agriculture



Food



Chemicals

and many more...

Ordering Info

Filter Paper circles

Product code	Size (dia in mm)	Pack size	List Price Price / Pack ₹
Grade B59501			
FPB595010070	70	100	1405.00
FPB595010090	90	100	1210.00
FPB595010110	110	100	1320.00
FPB595010125	125	100	1510.00
FPB595010150	150	100	1760.00
FPB595010185	185	100	2630.00
FPB595010240	240	100	5495.00
Grade B59702			
FPB597020070	70	100	1515.00
FPB597020090	90	100	1460.00
FPB597020110	110	100	1695.00
FPB597020125	125	100	1780.00
FPB597020150	150	100	2630.00
Grade B59303			
FPB593030070	70	100	2220.00
FPB593030090	90	100	2425.00
FPB593030110	110	100	2335.00
FPB593030125	125	100	3280.00
FPB593030150	150	100	3420.00
Grade B60404			
FPB604040047	47	100	1225.00
FPB604040055	55	100	1300.00
FPB604040070	70	100	1300.00
FPB604040090	90	100	1410.00
FPB604040110	110	100	1755.00
FPB604040125	125	100	1965.00
FPB604040150	150	100	2685.00
FPB604040185	185	100	3890.00
FPB604040240	240	100	6885.00
FPB604040320	320	100	11080.00

HSN Code 48232000

* Pack size 500 nos are available on request.

FILTER PAPER SHEETS

Product code	Size of sheets (in cm)	Pack size	List Price Price / Pack ₹
FPB595014657	46*57	100	14125.00
FPB597024657	46*57	100	23390.00
FPB593034657	46*57	100	42525.00
FPB604044657	46*57	100	29230.00

HSN Code 48054000

Accurate and Consistent Filtration, ALWAYS with BOROSIL

Finest Quality Filter Papers

Borosil filter papers are made in collaboration with Hahnemühle - the pioneers in speciality papers since 1883! The papers contain upto 98% alpha cellulose, the most stable form of cellulose in paper pulp, hence making the papers highly stable.

To ensure batch to batch uniformity and consistency in filtering performance, no recycled materials are used in the manufacturing processes. Very low ash content (Avg value 0.004%) aid the laboratory professionals in accurate quantitative analysis with minimal errors.

Made in Germany, the manufacturing processes and product specifications are compliant to the stringent European QC standards, guaranteeing the users finest quality filter papers.



Please contact CT Enterprises for quotation.

Email: sales@ctenterprises.in | Phone: +91 8977721310

BOROSIL[®] Scientific Laboratory Filter Media

Ashless Quantitative Filter Papers

Ashless filters (avg ash content 0.004 %) for quantitative analysis, routine gravimetric tests and sample preparation for instrumental analysis.



Laboratory
Filter Media

In technical collaboration with
Hahnemühle 
Life Science

Please contact CT Enterprises for quotation.

Email: sales@ctenterprises.in | Phone: +91 8977721310

Quantitative Filter Papers

Ashless quantitative filter papers for precise gravimetric tests, quantitative analysis of elements and sample preparation for instrumental analysis.

- Lowest ash content - 0.004%
- Made of refined cotton linters and cellulose
- Free of minerals and metallic ions, hence ideal for the detection of metallic ions
- Filter papers having >98% alpha cellulose, thereby ensuring highest stability and higher durability

Applications

- Determination and quantification of elements in soil, fertilizer, animal etc
- Gravimetric analysis in food products like milk and milk products, sugar, meat and meat products
- Quantitative analysis of elements in chemicals, pharmaceuticals, cement industry, food products etc
- Analysis of oil for its components
- Water analysis

Technical Data

Grade	Sample	Speed	Retention rate* [μm]	Filtration Herzberg (s)	Thickness (mm)	Weight [g/m^2]	Avg ash content
B58940	Fine crystalline precipitates	Medium	2-4	450	0.17	84	0.004%
B58941	Coarse and gelatinous precipitates	Fast	12-25	50	0.19	79	0.004%
B58942	Very fine crystalline precipitates	Slow	<2	750**	0.16	84	0.004%
B58943	Coarse precipitates	Medium Fast	4-12	140	0.18	85	0.004%
B58944	Fine crystalline precipitates	Slow thin	2	900	0.15	74	0.004%

* Approximate values,

** Measured with 100mm water column instead of 50 mm

● APPLICATIONS ●



Cement



Chemicals



Food

and many more...

Ordering Info

Filter Paper circles

Product code	Size (dia in mm)	Pack size	List Price Price / Pack ₹
Grade B58940			
FPB589400070	70	100	2450.00
FPB589400090	90	100	3060.00
FPB589400110	110	100	3660.00
FPB589400125	125	100	4585.00
FPB589400150	150	100	5885.00
FPB589400185	185	100	9750.00
FPB589400240	240	100	19625.00
Grade B58941			
FPB589410070	70	100	2520.00
FPB589410090	90	100	3195.00
FPB589410110	110	100	4290.00
FPB589410125	125	100	4880.00
FPB589410150	150	100	6335.00
FPB589410185	185	100	9185.00
Grade B58942			
FPB589420055	55	100	2010.00
FPB589420070	70	100	2520.00
FPB589420090	90	100	3060.00
FPB589420110	110	100	3855.00
FPB589420125	125	100	4585.00
FPB589420150	150	100	5885.00
Grade B58943			
FPB589430012	12.7	1000	4815.00
FPB589430125	125	100	4540.00
Grade B58944			
FPB589440090	90	100	3505.00
FPB589440110	110	100	4155.00
FPB589440125	125	100	4705.00
FPB589440150	150	100	8005.00
FPB589440185	185	100	11415.00

HSN Code 48232000

* Pack size 500 nos are available on request.

FILTER PAPER SHEETS

Product code	Size of sheets (in cm)	Pack size	List Price Price / Pack ₹
FPB589404657	46*57	100	62235.00
FPB589414657	46*57	100	58720.00
FPB589424657	46*57	100	56880.00

HSN Code 48054000

BOROSIL®

Accurate and Consistent Filtration, ALWAYS with BOROSIL

In technical collaboration with
Hahnemühle 
Life Science



Please contact CT Enterprises for quotation.

Email: sales@ctenterprises.in | Phone: +91 8977721310

Laboratory
Filter Media

BOROSIL[®] Scientific Laboratory Filter Media

Hardened Ashless Filter Papers for quantitative analysis :

Hardened ashless filters (ash content approx. 0.003%), especially recommended for filtration applications requiring vacuum and pressure filtration, and for the use of acidic and alkaline solutions.



Laboratory
Filter Media

In technical collaboration with
Hahnemühle 
Life Science

Please contact CT Enterprises for quotation.

Email: sales@ctenterprises.in | Phone: +91 8977721310

HARDENED ASHLESS FILTER PAPERS

Hardened ashless quantitative filter papers for quantitative and gravimetric analysis requiring high pressure or aggressive chemicals

- Avg ash content 0.003%
- Very high wet strength; hence easy to scrap off or wash off precipitates
- Hardened by small quantities of nitrogen-containing resin, which does not introduce significant impurities into the filtrate
- High resistance to aggressive chemical components, like sulphuric and nitric acids (up to 40 % at 50 ° Celsius) and alkalis (up to 10 % at 20 ° Celsius)
- Made of super-refined cotton linters and cellulose with alpha cellulose content more than 98%, hence higher stability and higher durability

Applications

- Gravimetric determination of metals in acidic/alkaline solutions.
- Quality control of chemicals
- Gravimetric analysis in oil refinery
- For analytical applications, routine quantitative and /or gravimetric procedures

Technical Data

Grade	Sample	Speed	Retention rate* [µm]	Filtration Herzberg (s)	Thickness	Weight [g/m ²]	Avg ash content
B15540	Fine crystalline precipitates	Medium	4-12	170	0.16	90	0.003%
B15541	Coarse crystalline precipitates	Fast	12-25	50	0.17	88	0.003%
B15542	Very fine crystalline precipitates	Slow	≤ 2	600**	0.14	90	0.003%

* Approximate values,

** Measured with 100mm water column instead of 50 mm

FILTER CIRCLES

Ordering Info

Product Codes	Size (dia in mm)	Pack size	List Price Price / Pack ₹
Grade B15540			
FPB155400125	125	100	6005.00
FPB155400150	150	100	8700.00
Grade B15541			
FPB155410125	125	100	5405.00
Grade 15542			
FPB155420125	125	100	6315.00
FPB155420150	150	100	9475.00

HSN Code 48232000



BOROSIL[®] Scientific Laboratory Filter Media

Glass Fiber Filter Papers

100% micro borosilicate glass fibres for specific applications
in environmental analysis



Laboratory
Filter Media

In technical collaboration with
 **Hahnemühle** 
Life Science

Please contact CT Enterprises for quotation.

Email: sales@ctenterprises.in | Phone: +91 8977721310

Glass Fibre Filters

Made of 100% micro-borosilicate glass fibres, these filters are recommended for air and water pollution analysis.

- Chemically stable in acidic solutions (except hydrofluoric acid) and alkaline solutions in moderate concentrations
- Extremely low metal content
- Maintains its properties up to 500°C
- High flow speed and high permeability to air

Applications

- Ambient air monitoring
- Determination of suspended particles (SPM and TSP) in air
- Monitoring of anthropogenic atmospheric emissions
- Gravimetric analyses of organic and inorganic contaminants in water and waste water

Technical Data

Type	Air permeability* (Resistance ** mbar) [L/m ² s]	Retention rate % NaCl-particle size <1 µm***	Filtration Gurley [s]	Weight [g/m ²]	Thickness [mm]	Max T [°C]	Retention range [µm]
BGF50A	25	99.97	19	56	0.29	500	1-3
BGF52C	54	99.995	25	54	0.28	500	1-3

* as per DIN 53887

** Air resistance at 400cm³/s, A = 10cm²

*** Tested with NaCl particles size <1 µm, main fraction at 0.3 to 0.5 µm

Ordering information

Product Codes	Size	Pack size	List Price Price / Pack ₹
FPBGF50A0037	37mm diameter	100	4270.00
FPBGF50A0047	47mm diameter	100	4450.00
FPBGF50A203254	203*254mm sheet (8*10 inches)	100	29905.00
FPBGF52C0047	47mm diameter	100	4495.00
FPBGF52C0090	90mm diameter	100	14250.00
FPBGF52C0125	125mm diameter	100	15720.00

HSN Code 70197100

Air Monitoring Filters

The increasing presence of particulate matter and pollutants poses severe risks to human health and the environment.

Protecting Earth's vital resource, air, is a global priority.

- Designed to detect and measure pollutants such as PM2.5, PM10, sulfur dioxide, fluorides, heavy metals, and radioactive substances.
- Utilizes gravimetric analysis for precise measurement.
- Employs membrane filter discs and filter holders for effective monitoring.

Ordering information

Product Codes	Size	Pack size	List Price Price / Pack ₹
FPBGFPEPM2000	203*254mm sheet (8*10inches)	100	55125.00
FPBPTPM25	PTFE PM2.5 filter discs 2 µm pore size, 46.2 mm dia.	100	19150.00

BOROSIL[®] Scientific Laboratory Filter Media

Thimbles

Cellulose and Glass Fibre thimbles for accurate and consistent extraction applications.



Thimbles



In technical collaboration with

Hahnemühle 
Life Science

Please contact CT Enterprises for quotation.

Email: sales@ctenterprises.in | Phone: +91 8977721310

THIMBLES

Cellulose and Glass fibre thimbles for extraction of components

- Extraction thimbles to be used in your regular soxhlet apparatus based applications
- Consistent, high porosity of thimbles ensuring a rapid flow rate
- Made of cellulose or glass fibre based on application

Applications- Cellulose thimbles

- Extraction of fatty, greasy materials in foodstuffs, paints, varnishes etc
- Extraction of active agents from pharmaceuticals and plastic softening agents
- Analysis of pesticide waste, polyaromatic carbohydrates and dioxins in foodstuffs.
- Determination of oil content in oil-bearing seeds

Applications- Glass Fibre thimbles

- Extraction of solvents which are incompatible with cellulose fibres
- Gravimetric collection of dust particles or aerosols from hot air and gas flows
- Extraction during special biochemical analysis

Technical Data

Product	Material	Wall Thickness (mm)	Weight (gsm)	Air Permeability (L/m ² sec)
Cellulose Thimble	100% cellulose without binder	1.6	2.7	25
Glass Fibre Thimble	100% Micro-glass fibre without binder	1.3	3	15

Ordering information

Product Codes	Description	Size (Inner dia x height)	HSN Code	Pack size	List Price Price / Pack ₹
FPBCTH01990	BCTH 19x90mm Cellulose Thimbles	19x90	48237090	25	11930.00
FPBCTH022080	BCTH 22x80mm Cellulose Thimbles	22x80	48237090	25	12400.00
FPBCTH022100	BCTH 22x100mm Cellulose Thimbles	22x100	48237090	25	12840.00
FPBCTH025080	BCTH 25x80mm Cellulose Thimbles	25x80	48237090	25	12255.00
FPBCTH025100	BCTH 25x100mm Cellulose Thimbles	25x100	48237090	25	12255.00
FPBCTH028100	BCTH 28x100mm Cellulose Thimbles	28x100	48237090	25	12315.00
FPBCTH033080	BCTH 33x80mm Cellulose Thimbles	33x80	48237090	25	14550.00
FPBCTH033100	BCTH 33x100mm Cellulose Thimbles	33x100	48237090	25	14580.00
FPBGFTH01990	BGFTH 19*90mm Glass Fibre Thimbles	19x90	70197100	25	20325.00

BORO PURE

Filtration Products

Membrane Filters

BORO PURE Membrane filters are used for applications such as HPLC mobile phase filtration, analysis of particulate or biological contaminants, small volume filtration of media and buffers.



Thimbles

Please contact CT Enterprises for quotation.

Email: sales@ctenterprises.in | Phone: +91 8977721310

5147 - BOROPURE CELLULOSE NITRATE MEMBRANE

Hydrophilic in nature and biologically inert

High retention and high flow rate

Available in two pore sizes - 0.22 micron and 0.45 micron

Autoclavable at 121°C for 30 mins for sterilization

Recommended for applications like clarification and sterilization of media, reagents and buffers, sterility testing, water testing, product and water microbiology

Tested for : Membrane integrity, Flow rate, Membrane thickness, Heat stability and Microbial Challenge Test



Product Code	Description	Pore size μm	Diameter mm	Membrane /pack Nos	Case lot	Price per pack ₹
514722N	Cellulose Nitrate Membrane, Non- sterile	0.22	47	100	5	1935.00
514745N	Cellulose Nitrate Membrane, Non- sterile	0.45	47	100	5	1935.00

* Sterile membranes available on Request

5247 - BOROPURE GRIDDED CELLULOSE NITRATE MEMBRANE

- Hydrophilic in nature and biologically inert
- High retention and high flow rate
- White membrane with black grids which make the colony counting easier
- Grids do not inhibit the growth of microorganisms
- Available in two pore sizes - 0.22 micron and 0.45 micron
- Autoclavable at 121°C for 30 mins for sterilization
- Recommended for applications like water testing, product and water microbiology
- Tested for : Membrane integrity, Flow rate, Membrane thickness, Heat stability , Microbial Challenge Test and Growth Inhibition



Product Code	Description	Pore size μm	Diameter mm	Membrane /pack Nos	Case lot	Price per pack ₹
524722N	Gridded Cellulose Nitrate Membrane, Non- sterile	0.22	47	100	5	2135.00
524745N	Gridded Cellulose Nitrate Membrane, Non- sterile	0.45	47	100	5	2135.00
524722SE	Gridded Cellulose Nitrate Membrane, ETO sterilized	0.22	47	100	5	2625.00
524745SE	Gridded Cellulose Nitrate Membrane, ETO sterilized	0.45	47	100	5	2625.00

* Sterile membranes available on Request

5347 - BOROPURE NYLON-66 MEMBRANE HPLC Grade

- Hydrophilic in nature and biologically inert
- Wide chemical compatibility and resistant to strong solvents and alcohols
- Available in two pore sizes - 0.22 micron and 0.45 micron
- Autoclavable at 121°C for 30 mins for sterilization
- Recommended for applications like clarification of aqueous and organic HPLC mobile phase solvents, HPLC sample preparations
- Tested for : Membrane integrity, Flow rate, Membrane thickness, Heat stability, Fibre/ particle release and Extractables

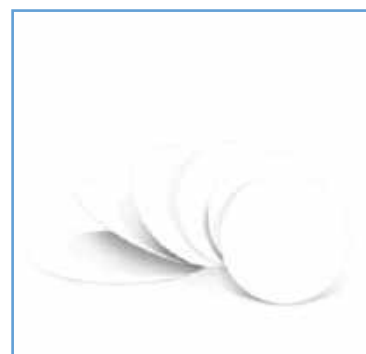

Product Code	Description	Pore size μm	Diameter mm	Membrane /pack Nos	Case lot	Price per pack ₹
534722N	Nylon-66 Membrane, Non- sterile	0.22	47	100	5	2240.00
534745N	Nylon-66 Membrane, Non- sterile	0.45	47	100	5	2240.00

* Sterile membranes available on Request

For membranes of other diameter and pore sizes, please contact our local sales representative

BOROPURE Syringe Filter

BOROPURE syringe filters combine premium quality and economy, are designed for quick, efficient filtration of samples upto 100ml volume. Filters are produced from polypropylene with standard inlet(female luer lock) and outlet(male luer) connections available in both sterile and non sterile.

Pure **PROTECTION**,
Precise **RESULTS**
for your chromatography

Features :

HPLC certified for low extractables.
IC certified for low levels of inorganic extractables.
Color coding for easy identification

Filter Type Available :

Nylon	Aqueous and Organic solutions
Hydrophobic PTFE	Aqueous and mild organic solvents
Hydrophilic PTFE	Organic Solvents
PES	High flow rate low extraction
PVDF	Aqueous and Organic solutions



Please contact CT Enterprises for quotation.

Email: sales@ctenterprises.in | Phone: +91 8977721310

Easy ordering!!!

The 7 Digit Code

STEP 7



STEP 1
Start with the Filter syringe

STEP 2
Select the membrane type- Nylon (NY), polyvinylidene fluoride membrane (PV), polyethersulfone membrane (PE), polytetrafluoroethylene (PT).

STEP 3
Select the Sterility- Non- sterile (0), sterile (1)

STEP 4
Select the membrane layer- single layer (S0), double layer (DG)

STEP 5
Select the membrane pore size- 0.2um (0.2), 0.45um (45)





STEP 6
Select the membrane diameter- 13, 25 mm

Select the membrane diameter- 13, 25 mm
Select the hydrophilic (IN), hydrophobic (EX)

1	FS	2	NY, PV, PE, PT	3	0, 1	4	S0, DG	5	0.2, 45	6	13, 25	7	IN, EX
---	----	---	----------------	---	------	---	--------	---	---------	---	--------	---	--------

TYPE	FS 13mm	FS 25mm
Housing	Polypropylene	Polypropylene
Filtration area	1.3 cm ²	4.6 cm ²
Maximum pressure	100 psi(8.6 bar)	75 psi(5.2 bar)
Volume hold up with full housing air purge	50 µl approx	250 µl approx
Flow direction	Flow should entry from the inlet	Flow should entry from the inlet
Inlet connection	Female luer lock	Female luer lock
Outlet connection	Male luer lock	Male luer lock
Sterilization	Autoclave at 121°C (max 131°C) at 15 psi for 20 mins	Autoclave at 121°C (max 131°C) at 15 psi for 20 mins

Syringe Filter colour coding for easy identification

COLOUR	MEMBRANE	
PURPLE	NYLON	
BLUE	PVDF	
YELLOW	PTFE	
NEUTRAL	PES	



SYRINGE FILTERS NYLON

BoroPURE nylon non-sterile syringe filter offers the following advantages :

- Works with a wide variety of solvents
- Offered in pore sizes of 0.20 μm and 0.45 μm , with two available diameters to meet specific application requirements
- Suitable for both aqueous and organic solutions, ensuring extensive chemical compatibility and versatility in the lab
- The polypropylene housing ensures minimal extractables and excellent overall chemical compatibility

Applications

Ideal for low volume aqueous solutions

Product Code	Membrane	Pore Size, μm	Diameter, mm	Pack Size in Pieces	Case lot	Price Per Pack of 100 ₹
FSNY0S02213000	NYLON	0.2	13	100	5x100	1750.00
FSNY0S02225000	NYLON	0.2	25	100	5x100	1710.00
FSNY0S04513000	NYLON	0.45	13	100	5x100	1750.00
FSNY0S04525000	NYLON	0.45	25	100	5x100	1710.00

Sterile syringe filter Nylon available on request



SYRINGE FILTER PVDF

The BoroPURE (PVDF) non-sterile syringe filter offers the following advantages:

- Low protein binding to reduce sample interaction and optimize recovery.
- Suitable for both aqueous and mild organic solutions.
- High-density polyethylene housing provides minimal extractables and broad chemical compatibility.

Applications

- Ideal for sample filtration prior HPLC, UHPLC, Mass spec, solvent filtration

Product Code	Membrane	Pore Size, μm	Diameter, mm	Pack Size in Pieces	Case lot	Price Per Pack of 100 ₹
FSPV0S02213000	PV	0.2	13	100	5x100	2450.00
FSPV0S02225000	PV	0.2	25	100	5x100	2450.00
FSPV0S04513000	PV	0.45	13	100	5x100	2450.00
FSPV0S04525000	PV	0.45	25	100	5x100	2450.00

Sterile syringe filter PVDF available on request

SYRINGE FILTER PTFE (HYDROPHILIC)

BoroPURE (Hydrophilic PTFE) Syringe filter non-sterile offers following advantages:

- Designed for the lowest extractables, ensuring minimal background interference in sensitive analyses such as UHPLC and LC-MS.
- Suitable for filtering protein-containing, aqueous, or organic solutions.
- Available in 0.20 µm and 0.45 µm pore sizes, with three diameter options to meet specific application requirements.

Applications

- Sample filtration before UHPLC, HPLC, and Mass Spectrometry.
- Solvent filtration.
- Clarification of aqueous and organic solutions.

Product Code	Membrane	Pore Size, µm	Diameter, mm	Pack Size in Pieces	Case Slot	Price Per Pack of 100 ₹
FSPT0S022130IN	PTFE	0.2	13	100	5x100	2275.00
FSPT0S022250IN	PTFE	0.2	25	100	5x100	2450.00
FSPT0S045130IN	PTFE	0.45	13	100	5x100	2275.00
FSPT0S045250IN	PTFE	0.45	25	100	5x100	2450.00

Sterile syringe filter PVDF available on request

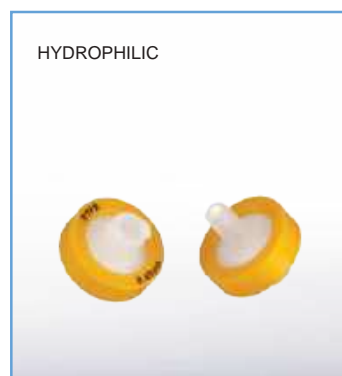

SYRINGE FILTER PTFE (HYDROPHOBIC)

BoroPURE (PTFE) syringe filter non-sterile offers the following advantages :

Non Sterile BoroPURE hydrophobic PTFE syringe filter is a 25 mm filter with a male Luer-slip outlet, designed for venting and gas filtration. It is ideal for filtering organic solutions in the 10–100 milliliter (mL) range to remove particles before instrumental analysis.

Applications

- Ideal for filtering alcohols concentrated acids and bases, as well as air or gases
- The BoroPURE-syringe filter is appropriate for filtering alcohols, concentrated acids and bases, as well as air or gases.

Product Code	Membrane	Pore Size, µm	Diameter, mm	Pack Size in Pieces	Case lot	Price Per Pack of 100 ₹
FSPT0S022130EX	PTFE	0.2	13	100	5x100	2275.00
FSPT0S022250EX	PTFE	0.2	25	100	5x100	2450.00
FSPT0S045130EX	PTFE	0.45	13	100	5x100	2275.00
FSPT0S045250EX	PTFE	0.45	25	100	5x100	2450.00

Sterile syringe filter PTFE available on request

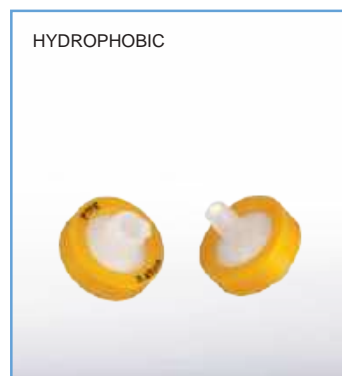

SYRINGE FILTER PES

BoroPURE (PES) non-sterile syringe filter offers the following advantages :

Non-sterile BoroPURE syringe filters with a polyethersulfone (PES) membrane enable rapid filtration of aqueous and mild organic solutions.

They feature low protein binding to reduce sample interaction and enhance recovery. The polypropylene housing ensures minimal extractables and broad chemical compatibility.

Applications

Ideal for filtering aqueous and mild organic solutions.

Product Code	Membrane	Pore Size, µm	Diameter, mm	Pack Size in Pieces	Case lot	Price Per Pack of 100 ₹
FSPE0S04525000	PES	0.45	25	100	5x100	2888.00

Sterile syringe filter PES available on request



Laboratory Equipment

LabQuest by Borosil are products that meet Borosil's high standards of reliability, performance and value.

All products are backed by Borosil's robust service and after sale support.



- PROXIMATE ANALYSIS
- ENVIRONMENTAL ANALYSIS
- LAB ESSENTIALS & SYNTHESIS EQUIPMENT
- LIQUID HANDLING SYSTEMS AND LIFE SCIENCE



Please contact CT Enterprises for quotation.

Email: sales@ctenterprises.in | Phone: +91 8977721310

PRACTICAL

Proximate Analysis

Complete Solution for Proximate Analysis

These cost-effective, user-friendly and automated instruments are designed for quick sample analysis, saving time and chemicals while handling urgent requests. They ensure accurate testing for protein, moisture, fat and fiber content in food, feed and agricultural products.

Our nutrition portfolio includes advanced Kjeldahl systems for nitrogen/protein analysis, precision moisture analyser, fat extraction systems and fiber determination solutions, delivering reliable and efficient results for quality assurance and regulatory compliance.



KJELDAHL SYSTEM

Save time, digest in 2X mins and distillation in 10X mins

Safe, Easy and Fully automatic



FAT ANALYSER

Automated boiling, rising and recovery

Up to 2 times faster than traditional method





FIBER ANALYSER

Fiber bag spacer method to increase throughput

Reduces time, efforts as compared to crucible method



MOISTURE ANALYSER

Halogen heating technology

After point three decimal digits for enhanced accuracy



Please contact CT Enterprises for quotation.

Email: sales@ctenterprises.in | Phone: +91 8977721310

PRACTICAL

Kjeldahl

Magnus Digesters

Automatic Kjeldahl Digestion unit with auto lift
8 / 12 / 20 position aluminium heating
block that offers excellent thermal
homogeneity and stability.



Technical Data & Ordering Information

Model Name	KBD083	KBD123	KBD203
Type	Block Digester	Block Digester	Block Digester
No. of positions	8	12	20
Tube capacity (ml)	250 / 400		
Temperature Range	Ambient to 470°C		
Timer Range	1-1200 mins		
Temperature Precision	±1°C		
Ramp and Hold	upto 4		
Presets	upto 50, editable		
Auto scrubber ON/OFF	Yes		
PID control	Yes		
Autolift	Yes		
Auto cut OFF after achieving set time	Yes		
Temperature Calibration	Yes, single and two point		
PC & Printer Connectivity	Yes, upgradable		
Display	Graphical LCD		
Body	Stainless steel with control panel of FRP		
Current Consumption	6A	8A	12A
Dimensions (W × D × H)	(416 × 554 × 595) mm		(410 × 585 × 735) mm
Power Consumption	1400W	2100W	2800W
HSN Code	84198990		
Ordering Code	BLFAKBD08300000000	BLFAKBD12300000000	BLFAKBD20300000000
Prices / Piece	On Request		

Kjeldahl

Oracle Digesters

Kjeldahl Digestion unit with 6 / 8 / 12 position aluminium heating block that offers excellent thermal homogeneity and stability.



Technical Data & Ordering Information

Model Name	KBD062	KBD082	KBD122
Type	Block Digester	Block Digester	Block Digester
No. of positions	6	8	12
Tube capacity (ml)	250/400		
Temperature Range	Ambient to 470°C		
Timer Range	1-1200 mins		
Temperature Precision	±1°C		
Ramp and Hold	upto 4		
Presets	upto 50, editable		
Auto scrubber ON/OFF	Yes		
PID control	Yes		
Autolift	No		
Auto OFF after achieving set time	Yes		
Temperature Calibration	Yes, single and two point		
PC & Printer Connectivity	Yes		
Display	Graphical LCD		
Body	Stainless steel with control panel of FRP		
Current Consumption	6A	6A	8A
Dimensions (W × D × H)	(410 × 585 × 735) mm	(410 × 585 × 735) mm	(416 × 554 × 595) mm
Power Consumption	1400W	1400W	2100W
HSN Code	84198990		
Ordering Code	BLFAKBD06200000000	BLFAKBD08200000000	BLFAKBD12200000000
Prices / Piece	On Request		

Optional Accessories

Oracle Kjeldahl Digesters

Description	Ordering Code	Prices / Piece
Viton Rubber Tube - 10 mm ID × 14 mm OD – 1 Mtr	BLA0VRT10D0014DBLK	4,200.00
Teflon Fume Cap ACCS (Case Lot – 01 No)	BLAAFUT100PTFE1651	2,040.00
KBD062 Fume Extractor	BLAAKBD06230000000	11,530.00
KBD080 Fume Extractor Glass ACCS	BLA0FUTKBD080D2510	13,830.00
KBD082 Fume Extractor	BLAAKBD08230000000	17,560.00
KBD083 Fume Extractor ACCS	BLAAKBD08330000000	18,610.00
KBD123 Fume Extractor ACCS	BLAAKBD12330000000	23,890.00
KBD200 Fume Extractor Glass ACCS	BLA0FUTKBD200D2510	16,270.00
KBD203 Fume Extractor ACCS	BLAAKBD20330000000	31,180.00
KBD062 Cooling Tray	BLAAKBD06170000000	7,330.00
KBD082 Cooling Tray ASM ACCS	BLAAKBD08250000000	7,740.00
KBD123 Cooling Tray ASM ACCS	BLAAKBD12350000000	9,770.00
KBD203 Cooling Tray ASM ACCS	BLAAKBD20350000000	12,200.00
KBD062 Test Tube Holder ACCS	BLAAKBD06220000000	7,660.00
KBD082 Test Tube Holder ACCS	BLAAKBD08220000000	13,290.00
KBD083 Test Tube Holder ACCS	BLAAKBD08320000000	15,620.00
KBD122 Test Tube Holder ACCS	BLAAKBD12200000000	18,570.00
KBD123 Test Tube Holder ACCS	BLAAKBD12320000000	20,680.00
KBD203 Test Tube Holder ACCS	BLAAKBD20320000000	22,750.00
250 ml Borosilicate Test Tube ASM (Case lot-5)	BLMATTB01041250000	11,620.00
400ml Borosilicate Test Tube ASM (Case lot-5)	BLAATTB01050400001	13,550.00
Quartz Test Tube 250ml ASM (Case lot-2)	BLGATTQ01041250000	10,210.00

Accessories

Magnus Kjeldahl Distillation / Oracle Kjeldahl Distillation

Optional Accessories

Description	Ordering Code	Prices / Piece
Silicon Transt Tube-8 mm ID × 10 mm OD - 1 Mtr	BLA0STT8D00012TRNP	220.00
Clear Braided PVC Hose Pipe ACCS - 1 Mtr	BLA0PIPPVC0HOS00CB	1,220.00
KDI PTFE Tube - 10 mm OD × 08 mm ID - 1 Mtr	BLA0TUB000PTFE1008	4,070.00
KDI FLOW SWITCH ASM ACCS	BLAAKDI05010000001	3,480.00
KDI Drip Tray ASM	BLA0KDI000DRP0TRAY	1,390.00
Oven Mittes - KDI ASM	BLA0OVM000KDI00000	570.00
KDI PP Jerry Can ACCS	BLA0JCNPP00000005L	750.00

Fume Scrubber

Safe, zero exposure & high capacity
fume scrubber for Kjeldahl digestion systems



KSC020

Technical Data & Ordering Information

Model Name	KSC010	KSC020
Current	1A	1A
Pump delivery Rate	28 Ltr/Min	45 Ltr/Min
Dimensions (W × D × H)	(445 × 375 × 460) mm	
HSN Code	84198990	
Ordering Code	BLFAKSC01000000000	BLFAKSC02000000000
Prices / Piece	On Request	

Optional Accessories

Model Name	Ordering Code	Prices / Piece
Silicon Transt Tube - 8 mm ID × 10 mm OD - 1 Mtr	BLA0STT8D00012TRNP	220.00
Viton Rubber Tube - 10 mm ID × 14 mm OD - 1 Mtr	BLA0VRT10D0014DBLK	4,200.00
Clear Braided PVC Hose pipe ACSS	BL0PIPPVC0HOS00CB	1,220.00
2L Reagent bottle - 1500030 ASM	BLA0BGW10001500030	2,380.00
KSC 020 Condenser V2 ASM	BLAAFUTV2KSCCD2932	5,380.00
KSC 010 Condenser V3 ACSS	BLAAFUTV3KSCCD2932	5,870.00
KSC Carbon Bottle ASM	BLAACRB02020018000	3,170.00

Kjeldahl

Magnus Distillation System with Inbuilt Autotitrator

Smart, efficient distillation systems for labs now available with Inbuilt Autotitration

Excellent features with high reliability and advance performance.



Technical Data & Ordering Information

Model Name	KDI060	Model Name	KDI060
Auto reagent addition	Distilled water	Alkali	Boric Acid
Steam addition	Automatic	Titration Type	pH base
Display	7" colored touch screen	Rinse receiver vessel with distilled water	Automatic
Tube Capacity (ml)	250 / 400 ml	Titration Cleaning Vessel	Automatic
Steam power regulation (Adjustable)	10 to 100%	Detection Limit	0.1ml
Minimum distillation time (mins)	5	Analysis time	Automatic
Reagent level sensor	Yes	Titration Residue Removal	Automatic
Anytime alkali addition	Yes	Boric Acid Addition	Automatic
Tube error detection	Yes	Burette Resolution	0.03ml/drop
Door close sensor	Yes	Power Supply	230V/50Hz
Process resume from stop	Yes	Current Consumption	10A
One point calibration alkali and distilled water pump	Yes	Power Consumption	1800 W
Two point calibration for acid pump	Yes	Dimension (L x B x H) mm	(480 x 470 x 820) mm
Real time monitoring of process parameter	Yes	HSN Code	84198990
SELV protection	Yes	Ordering code	BLFAKDI06000000000
Programs	40 preset, 10 user editable	Price / Piece	On Request
PC Connectivity	Yes		
Nitrogen recovery	>99.5%		
Nitrogen reproducibility	0.01		
RSD	<1%		
LOD	1-200mg with of = 0.1mg of Nitrogen		

Kjeldahl

Magnus Distillation System

Smart, efficient distillation systems for labs. Excellent features with high reliability and advance performance.



Technical Data & Ordering Information

Model Name	KDI050
Steam addition	Automatic
Distilled water addition	Automatic
Alkali addition	Automatic
Boric acid addition	Automatic
Tube Drain	Automatic
Display	7" colored touch screen
Tube Capacity (ml)	250 / 400 ml
Steam power (Adjustable)	10-100%
Minimum distillation time (mins)	5
Reagent level sensor	Yes
Anytime alkali addition	Yes
Tube error detection	Yes
Door close sensor	Yes
Process resume from stop	Yes
One point alkali and distilled water pump	Yes
Two point calibration for acid pump	Yes
Real time monitoring of process parameter	Yes
SELV protection	Yes
Programs	40 preset, 10 user editable
PC Connectivity	Yes
Nitrogen recovery	>99.5%
Nitrogen reproducibility	±1 %
RSD	<1%
LOD	1-200mg with of = 0.1mg of Nitrogen
Current Consumption	10A
Power consumption	1800 W
Dimension (L × B × H) mm	(480 × 470 × 820) mm
HSN Code	84198990
Ordering Code	BLFAKDI05000000000
Price / Piece	On Request

Kjeldahl

Oracle Distillation System

Smart, efficient distillation systems primarily for kjeldahl analysis with simple and reliable features.



Technical Data & Ordering Information

Model Name	KDI040
Steam addition	Automatic
Distilled water addition	Automatic
Alkali addition	Automatic
Boric acid addition	Automatic
Display	LCD
Tube Capacity (ml)	250 / 400 ml
Steam power (Adjustable)	25%-100%
Minimum distillation time (mins)	5
Reagent level sensor	Yes
Anytime alkali addition	Yes
Tube error detection	Yes
Door close sensor	Yes
Process resume from stop	Yes
One point alkali and distilled water pump	Yes
Two point calibration for acid pump	Yes
Real time monitoring of process parameter	Yes
SELV protection	Yes
User Editable Programs	50 Programs
PC Connectivity	Yes
Nitrogen recovery	>99.5%
Nitrogen reproducibility	±1 %
RSD	<1%
LOD	1-200 mg with of = 0.1 mg of Nitrogen
Current Consumption	5.5A
Power consumption	1000 W
Dimension (L × B × H) mm	(650 × 350 × 725) mm
HSN Code	84198990
Ordering Code	BLFAKDI04000000000
Price / Piece	On Request

Kjeldahl

Classical Distillation Unit

Safe, simple, efficient distillation systems for labs



CKD065

Technical Data & Ordering Information

Model Name	CKD015	CKD065
No. of positions	1	6
Flask Capacity	500 ml Kjeldahl Flask. Also compatible with 800 ml Kjeldahl Flask	
Element Temperature	450°C	
Temperature regulators	1	6
Display	LED Display with time, safe temperature & process status	
Timer	1-999 Minutes	
Power consumption	150 W	900 W
Electrical regulation	0.65 A	3.9 A
HSN Code:	84198990	
Ordering Code	BLFACKD01500000000	BLFACKD06500000000
Prices / Piece	On Request	On Request

Accessories

Description	Ordering Code	Prices / Piece
Graham Condenser 200mm Jacket ACCS	BLA0BGW200KJDLGHM0	4,890.00
CLASSICAL KJELDHAL SPLASH HEAD-2429 ACCS	BLA0KSH24291926CKJ	2,330.00
CKD065 with Stand ASM (Entire assembly without glass parts)	BLAACKD06500000000	75,770.00
CKD015 with Stand ASM (Entire assembly without glass parts)	BLAHCKD01510000000	3,870.00

Note : All accessories are provided by default with the unit

Alcohol Distillation Unit with Chiller

- Smart way to analyse alcohol content in sample.
- Quick distillation saves time
- A chiller gives effective condensation and helps detect close to accurate alcohol content.



Technical Data & Ordering Information

Model Name	KDI040
Tube capacity (ml)	250 ml/ 400 ml
Steam addition	Automatic
Display	24 × 7 LCD
Cooling water flow rate sensor	Yes
Drip tray	Yes
Visual reagent level warning	Yes
Steam power	Adjustable
Steam output regulation	25-100%
Maximum distillation time (mins)	20 mins
Tube error detection	Yes
Door close sensor	Yes
Control button	Rotary push button
Dimensions (W × D × H)	(380 × 350 × 725) mm
Current consumption (A)	5.5 A
Power consumption (W)	1000W
Voltage	230- 50/ 60 Hz
HSN Code	84198990
Ordering Code	BLFAKDI04000000000
Prices / Piece	On Request

Technical Data & Ordering Info

Model Name	CHL010
Tank capacity	8 L
Tank size (L × W × D) mm	(325 × 265 × 200) mm
Cooling capacity	1000 W
Pump flow rate	12.5 LPM
Display	LED
Temperature stability	± 1.0°C
Temperature range	-10 to ambient
HSN Code	84198990
Ordering Information	BLFRCHL010000000000
Prices / Piece	On Request

Fat Determination by Soxhlet Extraction

Delivering classical solutions with modernized approach for fat extraction



Technical Data & Ordering Information

Model Name	SOX012	SOX015	SOX062	SOX065
Positions	1	1	6	6
Flask Capacity (ml)	250	500	250	500
Extractor capacity (ml)	100	200	100	200
Display Timer	1-999 min			
Dimension (W × D × H)	200 × 300 × 800 mm		1050 × 300 × 800 mm	
Weight (Kgs)	7		15	
Power (W)	400 W		2400 W	
HSN Code	84198990			
Ordering Code	BLFRSOX 01200000000	BLFRSOX 01500000000	BLFRSOX 06200000000	BLFRSOX 06500000000
Price / Piece	On Request			

Accessories

Description	Ordering Code	Prices / Piece
SOX012 with Stand ASM (Entire assembly without glass parts)	BLAASOX01210000000	17,950.00
SOX015 with Stand ASM (Entire assembly without glass parts)	BLAASOX01510000000	19,010.00
SOX062 with Stand ASM (Entire assembly without glass parts)	BLAASOX06200000001	70,160.00
SOX065 with Stand ASM (Entire assembly without glass parts)	BLAASOX06500000001	80,610.00
SOXHLET 100 ML EXTRACTOR	BLA0SOXEXT10044327	5,500.00
SOXHLET 200ML EXTRACTOR	BLA0SOXEXT20048394	5,810.00
SOXHLET CONDENSER FOR 100ML EXT V2 ACCS	BLA0CON000SOX100V2	7,330.00
SOXHLET CONDENSER FOR 200ML EXT V2 ACCS	BLA0CON000SOX200V2	7,970.00

Rapid Fat Analyser

- Rapid fat extractor with benchmarking features of auto solvent Recovery, Boiling & Rinsing process
- Individual operating positions
- Up to 2 times faster than traditional method
- Water flow detection for condenser
- Easy to remove condenser for cleaning



Technical Data & Ordering Information

Model Name	FAS060
No of positions	6
Individual Operating Position	Yes
Sample size	0.5 gm to 10 gm
Recovery of Solvent	80-85%
Limit of detection	0.1% to 100 %
Display	7" touch screen
Heating profile	Energy regulator 1 to 10
Water flow sensor	Yes
Beaker solvent capacity	150 ml
Condenser	Seal Viton (FKM)
Chiller water temp	10-15°C
Heater temp range	280°C
Recovery bottle capacity	2 liter
Flow cut off sensor	Yes
Vacuum pump flow rate	7 LPM
Power supply	230 V 50 – 60 Hz
Current Consumption	5.2A
Power consumption	1500 W
Dimensions (L × B × H) mm	(700 × 355 × 660) mm
HS Code	84198990
Ordering code	BLAFAS06000000000
Price / Piece	On Request

Note : For optimization of processes, Recommended for chillers.

Accessories

Description	Ordering Code	Pack Size	Price/ pack
FAS060 CELLULOSE THIMBLE 33X80 MM ACCS	BLA0FAS060THIM3380	25	14,550.00
FAS060 THIMBLE HOLDER ACCS	BLA0FAS060000000003	6	On Request
FAS060 BEAKER 55MM DIA ACCS	BLA0FAS060BKR55124	6	On Request
FAS060 RANDALL CONDENSER ACCS	BLA0FAS060CON56326	1	On Request

Rapid Fiber Analyser

- Fiber bag spacer method to increase throughput
- Automatic agitation using radial flow stirrer for maximum efficiency
- Non - Pressurized system for user safety
- Buzzer alert upon process completion
- Drop in coupling to ensure perfect head to base fit
- Compact design reducing bench space
- Performs Crude Fiber, ADF, ADL and NDF determinations
- Use a fat extrol for to defat sample before fiber analysis



Technical Data & Ordering Information

Model Name	MFB008
No of positions	8
Sample size	0.5 - 3 gm
Measuring Range	0.1 % - 100 %
Drop-in coupling	Yes
Fiber bag material	Nylon
Agitation	Automatic
Stirrer type	Radial flow stirrer
Beaker volume	3 L
Reagent required per process (acid & alkali)	1.2 liter
Power supply	200 - 240 V 50 - 60 Hz
Current Consumption	4A
Total Power consumption	750 Watts
Dimensions (LxBxH) mm	(235 × 370 × 644) mm
HS Code	84198990
Ordering code	BLFAMFB00800000000
Price / Piece	On Request

Note : For optimization of processes, Recommended for chillers.

Accessories

Description	Ordering Code	Pack Size	Price/ pack
MFB008 Fiber Filter Bag ACCS	BLAAMFB008CRC00000	300	27,000.00
MFB008 GLASS SPACER ACCS	BLAAMFB00810000004	2	6,750.00
MFB008 INSERT RACK ACCS	BLARMFB00811000000	1	On Request
MFB008 SILICA CRUCIBLE WITH LID ACCS	BLAAMFB008CRCLIDAC	8	On Request
MFB008 Fiber Filter Bag ADF/NDF ACCS	BLAAMFB008CRC0ADND	300	On Request

Moisture Analyser

- Ultra-fast and uniform halogen heating
- Increased capacity of 60gm
- Mono-tech sensor for accurate results
- User Friendly Interface
- Different Drying Modes for variety of application



Technical Data & Ordering Information

Model Name	MB63
Readability	0.001
Repeatability (Sd) for initial sample wt. = 2gm	0.10%
Repeatability (Sd) for initial sample wt. = 10gm	0.03%
Units of measurements	%M, %D, %R (Ratio), Gm/Lt, %M Atro, %D Atro
Data Storage	Last 1000 moisture determination results
Max. sample weight	60gm
Minimum sample weight	0.2gm
Readability	0.001gm
Technology	Halogen
Temperature Range	30 - 175 °C (Optional 250 °C)
Temperature Increment	1°C
Switch off criteria	Auto manual, User Def weight /Time, User Def % Unit/Time, Intelligent
Auto Method development	Intelligent
Method memory	40
Batch Memory	100
Method designation	Alpha numeric
Serial number	Yes
Display	Graphical display with LED backlight
Data interface	Rs.232 C bidirectional, USB Ethernet
Print	GLP/GMP compliant, User configurable
Test	Weighing and heater
Weight in assist	Yes
Weight	5 Kg
Power Supply	230V/50Hz or 115V/60Hz
Power Consumption	415 W
Current Consumption	1.8A
Dimension (W × D × H) mm	(211 × 342 × 178) mm
HS Code	90160010
Ordering Code	100MB630000000
Price / Piece	On Request

Accessories

Description	Ordering Code	Pack Size	Price/ pack
Aluminium Dish	100MB63DAD0000	40	9,000
Glass Fiber Filter- 47 mm	FPBGF50A0047	100	4,450
Calibration Weights	100MB63CTWF100	1	40,700
Temperature Calibration Kit	100MB63TCK0000	1	24,200

Recommended Scrubbers and Chillers for Enhanced Performance

Kjeldahl Digestion Compatible scrubber Details

Product code	Model number	Compatible Scrubber
BLFAKBD06200000000	KBD062	KSC010
BLFAKBD08200000000	KBD082	KSC010
BLFAKBD08300000000	KBD083	KSC010
BLFAKBD12200000000	KBD122	KSC020
BLFAKBD12300000000	KBD123	KSC020
BLFAKBD20300000000	KBD203	KSC020

Kjeldahl Distillation Compatible Chiller Details

Product code	Model number	Compatible Chiller
BLFAKDI04000000000	KDI040	Up to 6 sample CHL010 above 6 sample CHL020
BLFAKDI05000000000	KDI050	CHL020
BLFAKDI06000000000	KDI060	CHL020

FAT & Fiber Compatible Chiller Details

Product code	Model number	Compatible Scrubber
BLFRSOX01200000000	SOX012	CHL500
BLFRSOX01500000000	SOX015	CHL500
BLFRSOX06200000000	SOX062	CHL010
BLFRSOX06500000000	SOX065	CHL010
BLFAFAS06000000000	FAS060	CHL010
BLFAMFB00800000000	MFB008	CHL500



Environmental Analysis

These user-friendly, cost-effective tools are perfect for handling routine samples, quick turnarounds, or urgent requests, ensuring precise testing for quality of surface water, groundwater, wastewater, and drinking water. Our environmental portfolio includes advanced UV-Vis spectrophotometers, portable water photometers, and a range of electrochemistry instruments for pH, conductivity, TDS, ORP, DO along with BOD and COD analysis solutions for efficient environmental monitoring.



ELECTROCHEMISTRY

Versatile Measurement Capabilities

Features like Data logging , Sensor Management & Auto Temperature Compensation

PHOTOMETER

Analyzes over 140 parameters

Designed for fast, efficient, and accurate water quality analysis

For more details

Please contact CT Enterprises for quotation.

Email: sales@ctenterprises.in | Phone: +91 8977721310



UV VISIBLE SPECTROPHOTOMETER

High-Performance Optics

Data integrity and compliance

COD ANALYSER

Flexible Analysis - Supports open and closed reflux methods

Enhanced Efficiency – Graphical representation, PID Controller, and user preset functionality

Please contact CT Enterprises for quotation.

Email: sales@ctenterprises.in | Phone: +91 8977721310

RACTICAL

Quanta- UV Visible Spectrophotometer

NEW PRODUCT

- Engineered for optimal speed and performance, the Quanta Pro series offers variable spectral bandwidth from 0.1 nm to 5 nm, scanning a wavelength range from 190-1100 nm.
- Its advanced dual-beam optics provide exceptional precision.
- With the added option of a touchscreen, it gives you the flexibility to prioritize either maximum compliance or enhanced productivity.
- Spacious sample compartment designed to accommodate a wide range of accessories, supporting diverse industrial applications.
- Capable of measuring highly absorbing liquids and translucent films and glass material (up to 4A)
- Enhanced scan speeds for efficient analysis of chemical kinetics
- Superior wavelength accuracy, photometric consistency, and minimal stray light
- Integrated methods for quick and straightforward analysis



Technical Data & Ordering Information

Parameter	Quanta Pro	Quanta Promax
Colored Touch Screen Display	10inch	10inch
Photometric system	True Double beam Optics	True Double beam Optics
UV/Vis Bandwidth Type	Fixed	Variable
Wavelength range	190 to 1100 nm	180 to 1100 nm
UV/Vis Bandwidth Increments (nm)	1 nm	0.1 nm to 5.0 nm
Wavelength Display Resolution (nm)	0.1nm	0.1 nm
Measuring Modes	ABS, %T, CONC with custom K-Factor and multiple standards	ABS, %T, CONC with custom K-Factor and multiple standards
Wavelength Accuracy	+/-0.05 nm @ 656.1 nm +/-0.1 nm entire range	+/-0.1 nm @ 656.1 nm +/-0.1 nm entire range
Wavelength Repeatability	+/-0.1 nm	+/-0.1 nm
Wavelength Slew rate	About 29000 nm/min	About 6000 nm/min
Wavelength Scan speed (nm/min)	3600 to 2 nm/min for survey of 29000 nm/min	4000 to 2 nm/min
Lamp interchange wavelength	Automatic changeover of wavelength with configurable wavelength.	Automatic changeover of wavelength with configurable wavelength.
Stray light	Less than 0.02% at 220 nm (NaI) Less than 0.02% at 340 nm (NaNO ₂) Less than 0.5% at 198 nm (KCl)	Less than 0.02% at 220 nm (NaI) Less than 0.02% at 340 nm (NaNO ₂) Less than 1.0% at 198 nm (KCl)
Photometric readability range (Abs)	Absorbance: -4.0 to 4.0 Abs Transmittance : 0% to 400%	Absorbance: -4.0 to 4.0 Abs Transmittance : 0% to 400%
Photometric accuracy	+/-0.002 Abs at 0.5 Abs +/-0.004 Abs at 1.0 Abs +/-0.006 Abs at 2.0 Abs	+/-0.002 Abs at 0.8 Abs +/-0.004 Abs at 1.2 Abs +/-0.006 Abs at 2.1 Abs

Parameter	Quanta Pro	Quanta Promax
Photometric repeatability	Less than +/-0.001 Abs at 0.5 Abs Less than +/-0.001 Abs at 1 Abs Less than +/-0.003 Abs at 2 Abs	Less than +/-0.001 Abs at 0.8 Abs Less than +/-0.001 Abs at 1.2 Abs Less than +/-0.003 Abs at 2.1 Abs
Baseline stability	Less than 0.0002 Abs/Hr @700 nm	Less than 0.0002 Abs/Hr @700 nm
Baseline flatness ($\pm A$)	Less than +/-0.0005 Abs (avg. points)	Less than +/-0.0005 Abs (avg. points)
Noise level	Less than 0.00003 Abs (700 nm)	Less than 0.00005 Abs (700 nm)
Light source	Plug- in pre-aligned Halogen lamp and Deuterium lamp or Xenon Lamp	Plug- in pre-aligned Tungsten Halogen lamp and UV Deuterium lamp
Monochromator	Blazed holographic grating 1200 lines/mm in Czerny Turner mounting	Blazed concave holographic grating 1200 lines/mm in Czerny Turner mounting
Detector	Dual Silicon photodiode	Dual matched silicon photodiode
Environmental requirements	Temperature 15 to 38 Humidity 30% to 80%	Temperature 15 to 38 Humidity 30% to 80%
Output device	Inbuilt with desktop OS with high resolution 10inch touch screen LCD	Inbuilt with desktop OS with high resolution 10inch touch screen LCD
Software	Scanalyser software (Microsoft windows 7 and above) CFR 21 compliance	Scanalyser software (Microsoft windows 7 and above) CFR 21 compliance
Validation	Automatic measurement and pass/ fail evaluation and printing of results	Automatic measurement and pass/ fail evaluation and printing of results
Connectivity	LAN/ Ethernet/WiFi/Bluetooth	LAN/ Ethernet/WiFi/Bluetooth
Sample compartment internal dimensions (W x D x H) mm	115 x 250 x 90 mm Distance between light beams :80 mm	115 x 250 x 90 mm Distance between light beams: 80 mm
Dimensions (L x B x H) mm	560 x 430 x 195 mm	556 x 486 x 236 mm
Power Supply	230V/50 Hz	230V/50 Hz
Ordering Code	100UVFIX000000	100UVVAR000000
HS Code	90273020	90273020
Weight	22 Kg	24 Kg
Prices / Piece	On Request	On Request

Accessories

Description	Ordering Code	Price
Variable Slit	100UVVS000000	66667.00
8 Cell round Auto Sampler	100UV08RAS0000	38096.00
7 Cell Linear Auto Sampler	100UV07LAS0000	34286.00
Peliter based Temperature controlled Single Cell 4 (Sample) 15-65c	100UV04PTC0000	66667.00
Peliter based Temperature controlled Single Cell (Sample) 0-99c	100UV01PTC0000	On Request
Thin Film Holder	100UVTFH000000	10477.00
0.5ml Quartz Cuvette Pair	100UV005QCP000	14286.00
1.0ml Quartz Cuvette Pair	100UV010QCP000	12381.00
3.5ml Quartz Cuvette Pair	100UV035QCP000	10477.00
50mm pathlength Quartz Cuvette Pair	100UV050QCP000	12381.00
100mm pathlength Quartz Cuvette Pair	100UV100QCP000	19048.00
0.5ml Glass Cuvette Pair	100UV005GCP000	5715.00
1.0ml Glass Cuvette Pair	100UV010GCP000	5715.00
3.5ml Glass Cuvette Pair	100UV035GCP000	3810.00
50mm pathlength Glass Cuvette Pair	100UV050GCP000	9524.00
100mm pathlength Glass Cuvette Pair	100UV100GCP000	14286.00
Dust Cover	100UVDC0000000	1905.00
USB Connection Cable	100UVUSB000000	1048.00
LAN Connection Cable	100UVLAN000000	1048.00
Fuse Set	100UVFUSE000000	477.00
Power Cord	100UVPOWC000000	1429.00

Primelab 2.0 **NEW PRODUCT**

- Measures over 140 parameters
- Best in class 18 wavelengths (410–940 nm)
- 5.5" color HD touch display
- Built-in camera (QR code scanner)
- USB Type-C* connectivity
- WiFi, USB, 4G**, Bluetooth® support
- Probe connector for pH, EC, TDS, Temperature, and ORP measurement



Technical Data & Ordering Information

Model Name	Prime Lab 2.0
Spectral range	390nm - 950nm 18 wavelength, peaks at 410/435/460/485/510/535/560/ 585/610/645/680/705/730/760/810/860/900/940nm 180° and 90° Setup for direct and indirect measurement
Parameters	more than 140 parameters
Electrodes	USB-type-C connector for pH/ EC/ TDS/ ORP/ Temp-Probes
Connectivity (technical)	Bluetooth 4.2 WiFi USB (type C) 4G* (via USB-modem)
Connectivity (software)	LabCOM Software (Windows / Mac) LabCOM App (Android / iOS) LabCOM Cloud (web-browser)
Display	5.5" Color-HD touch display
Camera	In-build barcode / QR-code scanner
Calibration	Auto-calibration function with certificate (software)
One-Time-Zero	Intelligent OTZ (One-Time-Zero) function with recognition of ZERO types
Internal memory	>5,000
Clock/Date	RTC (Real-Time-Clock) with calendar function
Auto-Off	Factory default setting = 10 minutes. Individual adjustment possible
Menu guidance	Intuitive, display-controlled 4-button menu guidance; test instructions during measurement process
Power supply	8,500 mA Li-Io-battery
Languages	>15
Environment	5°C - 45°C / 30 - 90% rel. humidity
Water-proof rating	The device is splash-water-proof (IP54)
Reagents	The calibration curves for the individual parameters / measurement procedures are adjusted to the reagents offered with the unit.
Weight	715 g
Dimensions (W × D × H) mm	100 × 59 × 255 mm
HS Code	90275000
Ordering Code	100PL02B000000
Price / Piece	On Request

Accessories provided by default with the kit

- LabCOM App/Software/Cloud (Android, iOS, Windows, Mac, Browser)
- 4 × 24 mm/10 ml glass-vials with lid (light-shield incorporated into the lid)
- 1 × light shield (for 16 mm and 1 ml vials as well as check-standards)
- 1 × 24 mm vial adapter (built-in; exchangeable)
- 1 × 10.5 cm stirring rod
- 1 × 10 ml plastic syringe (graduated)
- 1 × vial cleaning brush
- 1 × microfibre cleaning cloth for vials
- 1 × charger with cable (USB-Type-C)
- 1 × printed user manual in a ring-binder

COD Digestion Unit

Open Reflux COD Digesters-Ideal solutions for waste water analysis



Technical Data & Ordering Information

Model Name	COD082	COD152	COD080	COD150
Reflux Type	Open	Open	Open	Open
Positions	08 Position	15 Position	08 Position	15 Position
Capacity	250 ml × 08 tubes	250 ml × 15 tubes	250 ml × 08 tubes	250 ml × 15 tubes
Heating Block	Aluminium			
Temperature Range	Ambient to 180°C			
Temperature Accuracy	±1°C		±10°C	
Display	Front GRP control panel with Graphic LCD		LED	
Graphical representation of time and temp	Yes		No	
Two point factory calibration	Yes			
PID autotune	Yes			
User presets	Yes			
Process Timer	0 - 999 min			
Temperature Control	Yes with Set value and Present value			
Time Control	Yes with Set value and Present value			
Connectivity to Printer	Yes		No	
Connectivity to PC	Yes		No	
Power consumptions	1400W	1800 W	1200W	1600W
Current Consumption	6 A	8 A	6 A	8 A
Unit External Dimensions (W × D × H)	(414 × 414 × 283) mm		(414 × 414 × 283) mm	
HSN Code	84198990			
Ordering Code	BLFACOD 08200000000	BLFACOD 15200000000	BLFACOD 08000000000	BLFACOD 01500000000
Prices / Piece	On Request			

Description	Ordering Code	Pack Size	Prices / Piece
COD air condensers	BLMACND100 CODSAC00	5	7,480.00
COD digestion vessels	BLMATUB100CODSGT20	5	6,660.00

Note : Digestion vessels and air condensers are provided by default with the unit

Thermoreactor

Closed reflux COD digester
Compact and Convenient



Technical Data & Ordering Information

Model Name	COD120
Reflux Type	Sealing
Positions	12 Position
Capacity	16 mm × 100 mm vials
Heating Block	Aluminium
Temperature Range	Ambient to 180°C
Temperature Accuracy	±1°C
Display	LED
Process Timer	0-999 min / Infinite
Temperature Control	Yes with Set value and Present value
Time Control	Yes with Set value and Present value
Transparent Lid	UV protection
Power consumptions	200 W
Current Consumption	1.5 A
Unit External Dimensions (W × D × H)	(275 × 185 × 150) mm
HSN Code	84198990
Ordering Code	BLFHCOD120P0000000
Prices / Piece	On Request

Note : 12 nos. digestion tube provided by default with the unit
#BOD Measuring System - Prices on request.

Bench Top pH Meter 80 Pro

**NEW
PRODUCT**

Bench pH meter comes with Electrode Standard DHS

- pH meter, digital benchtop ionometer for advanced laboratory analysis. Automatic pH calibration (6 buffer families) or manual, on 5 values.
- ISE calibration from 2 to 5 points.
- Automatic and manual ORP calibration (1 point).
- Calibration deadline warning and/or measurement block.
- Alarm setting and display functions in analogue format, "Stop-reading" and "Stability" with titration mode (Tit) and time stability for ISE, self-diagnosis messages.



Technical Data & Ordering Information

Model Name	pH 80 Pro
Temperature accuracy	±0.2 °C
Temperature compensation	0.0 ... +100.0 °C
Measuring range mV	-2000 ... +2000 mV
pH measuring range	-2.000 ... +20.000 pH
Temperature measurement range	-30.0 ... +130.0 °C
pH resolution	0.1 / 0.01 / 0.001 pH
Temperature Resolution	0.1 °C
PC Communication	USB type B
Printer connection	RS 232
Criteria for stability	Med - High - Tit, Secondi (ISE)
Display	4.3" high-definition, backlit color TFT
AQA	Yes
Display with icon	Yes
Memory / Datalogger	8000
pH calibration points	1 ... 5 automatic values - 1 ... 5 user values
pH alarm range	Min - Max
Recognised pH buffers	USA - NIST - DIN 19266
Analog view	Yes
Power supply	100 - 240 V
Ordering Code	100PHB080000000000
HS Code	90278930
Prices / Piece	On Request

Bench Top pH Meter 60 VioLab

**NEW
PRODUCT**

Bench pH meter comes with Electrode 201 T

- 0.1 / 0.01 pH resolution
- Automatic temperature compensation
- Manual and automatic data logger, up to 1000 data in GLP
- Automatic calibration from 1 to 3 points
- DHS digital sensor management



Technical Data & Ordering Information

Model Name	pH 60 VioLab
Temperature accuracy	±0.5 °C
Temperature compensation	0.0 ... +100.0 °C
Measuring range mV	-1000 ... +1900 mV
pH measuring range	-2.00 ... +16.00 pH
Temperature measurement range	-10.0 ... +110.0 °C
pH resolution	0.1 / 0.01 pH
Temperature Resolution	0.1 °C
Features	PC Communication Micro USB
Printer connection	RS 232
Criteria for stability	Low - Med - High
Display	High-definition, backlit color LCD
AQA	Yes
Display with icon	Yes
Memory / Datalogger	1000
pH calibration points	1 ... 3 automatic values - 2 user values
Calibration Report	Yes, printable
Recognised pH buffers	USA - NIST
Display	Si
Ordering Code	100PHB060000000000
HS Code	90278930
Prices / Piece	On Request

Benchtop Multiparameter PC 60 VioLab

**NEW
PRODUCT**

Bench Multiparameter - comes with
Electrode 201 T - Cell 2301 T

- Resolution 0.1 / 0.01 pH - 0.01 μ S
- Manual or automatic temperature compensation
- Manual and automatic data logger, up to 1000 data in GLP
- Connection to PC and printer
- DHS digital sensor management



Technical Data & Ordering Information

Model Name	PC 60 VioLab
Accuracy COND	$\pm 2\%$ f.s.
Accuracy (pH)	± 0.02 pH
Temperature accuracy	± 0.5 °C
TDS factor	0.40 ... 1.00
Measuring range COND	0.00 μ S ... 200 mS
ORP measuring range	-1000 ... +1900 mV
pH measuring range	-2.00 ... +16.00 pH
Salinity measuring range	0.1 ppm ... 100 ppt
TDS measuring range	0.1 mg/l ... 200 g/l
Temperature measurement range	-10.0 ... +110.0 °C
COND Resolution	0.01 / 0.1 / 1 μ S/cm (automatic scale)
ORP resolution	0.1 / 1 mV
pH resolution	0.1 / 0.01 pH
Temperature Resolution	0.1 °C
Reference temperature	+15 ... +30 °C
Features	DHS compatibility Yes
Printer connection	RS 232
Display	0.1 / 1 / 10
Criteria for stability	Low - Med - High (pH)
Display	High-definition, backlit color LCD
Memory	1000 data
Calibration points	Cond 1...4
ORP calibration points	1
pH calibration points	1...3 automatic values - 2 user values
Recognised pH buffers	USA - NIST - 2 custom values
Ordering Code	100MPB060000000000
HS Code	90278930
Prices / Piece	On Request

Portable pH Meter pH 70 Vio

**NEW
PRODUCT**

Portable pH meter comes with Electrode 201 T

- 0,1 / 0,01 pH resolution
- High-resolution, backlit color LCD display
- Manual or automatic temperature compensation
- Manual and automatic data logger, up to 1000 data in GLP
- DHS digital sensor management



Technical Data & Ordering Information

Model Name	pH 70 Vio
Temperature accuracy	±0.5 °C
Temperature compensation	0.0 ... +100.0 °C
Measuring range mV	-1000 ... +1900 mV
pH measuring range	-2.00 ... +16.00 pH
Temperature measurement range	-10.0 ... +110.0 °C
pH resolution	0.01 / 0.1 pH
Temperature Resolution	0.1 °C
Features	PC Communication Micro USB
Criteria for stability	Low - Med - High
Display	High-definition, backlit color LCD
AQA	Yes
Display with icon	Yes
Memory / Datalogger	1000 data
pH calibration points	1 ... 3 automatic values - 2 user values
Calibration Report	Yes
Recognised pH buffers	USA - NIST
Ordering Code	100PHP070000000000
HS Code	90278930
Prices / Piece	On Request

Bench Top Conductivity Meter - COND 60 VioLab



Bench Top Conductivity Meter comes with Cell 2301 T

- Resolution 0,01 μ S
- Manual or automatic temperature compensation
- Manual and automatic data logger, up to 1000 data in GLP
- High-resolution, backlit color LCD display



Technical Data & Ordering Information

Model Name	COND 60 VioLab
Accuracy COND	$\pm 2\%$ f.s.
Temperature accuracy	± 0.5 °C
TDS factor	0.40 ... 1.00
Measuring range COND	0.00 μ S ... 200 mS
Salinity measuring range	0.1 ppm ... 100 ppt
TDS measuring range	0.1 mg/l ... 200 g/l
Temperature measurement range	0.0 ... 100.0 °C
COND Resolution	0.01 μ S/cm - mS/cm
Temperature Resolution	0.1 °C
Working temperature	0 ... +45 °C
Reference temperature	+15... +30 °C
PC Communication	Micro USB
Printer connection	RS 232
Display	High-definition, backlit color LCD
AQA	Yes
Memory	1000
Output	Micro USB - RS 232
Calibration points	Cond 1 ... 4
Ordering Code	100CDB060000000000
HS Code	90278930
Prices / Piece	On Request

Portable Conductivity Meter

COND 70 Vio

**NEW
PRODUCT**

Portable Conductivity Meter comes with Cell 2301 T

- pH meter, digital benchtop ionometer for advanced laboratory analysis.
- Automatic pH calibration (6 buffer families) or manual, on 5 values.
- ISE calibration from 2 to 5 points.
- Automatic and manual ORP calibration (1 point).
- Calibration deadline warning and/or measurement block.
- Alarm setting and display functions in analogue format, "Stop-reading" and "Stability" with titration mode (Tit) and time stability for ISE, self-diagnosis messages.



Technical Data & Ordering Information

Model Name	COND 70 Vio
Accuracy COND	±2% f.s.
Salinity accuracy	±1% f.s.
Accuracy (TDS)	±1% f.s.
Temperature accuracy	±0.5 °C
Temperature coefficient (max)	0.00 ... 10.00 % / °C
Temperature compensation	0.00 ... 100.00 °C % / °C
TDS factor	0.40 ... 1.00
Measuring range COND	0.00 µS ... 200 mS
Salinity measuring range	0.1 ppm ... 100 ppt
TDS measuring range	0.1 mg/l ... 200 g/l
Temperature measurement range	-10.0 ... +110.0 °C
COND Resolution	0.01 / 0.1 / 1 (automatic scale) µS/cm
Temperature Resolution	0.1 °C
Working temperature	0 ... +45 °C
Reference temperature	+15 ... +30 °C
PC Communication	Micro USB
Display	0.1 - 1 - 10, High-definition, backlit color LCD
AQA	Yes
Memory	1000
Output	Micro USB
Calibration points	Feeds 1 ... 4 automatic values - 1 user value , 84 µS - 147 µS - 12.88 µS - 111.8 µS
Cell Type	2 Rings
Ordering Code	100CDP0700000000000
HS Code	90278930
Prices / Piece	On Request

Oxy 70 Vio portable oxymeter



Portable Oxymeter comes with Optical sensor 2 m

- High accuracy with low oxygen level
- High resolution backlit coloured LCD Display
- Automatic compensation of temperature and pressure
- Data logger auto and manual, up to 1000 savings in GLP
- GLP with date and time of the last calibration.
- Auto calibration DO 0%-100%
- Optical sensor maintenance free



Technical Data & Ordering Information

Model Name	OXY 70 Vio
Parameter	Value
Accuracy DO (10 ... 20 mg/l - ppm)	±0.3 °C
Temperature measurement range	-10.0 ... +110.0 °C
Temperature Resolution	±0.1 °C
Working temperature	0.0 ... +45.0 °C
DO resolution	0.01 / 0.1
Barometric pressure resolution	1 mbar
O ₂ saturation resolution	0.1 / 1 %
Calibration Report	Yes
Calibration due date timer	Si
Regulations	CE
Power supply	3 x AA batteries 1.5 V
Dimensions (WxDxH)	185 x 85 x 45 mm
Weight	0.4 Kg
Ordering Code	100DOP0700000000000
HS Code	90278930
Prices / Piece	On Request

Guide to Selecting, Using, and Maintaining Electrodes

Electrode Type	Types	Key Factors	Applications	Maintenance & Regeneration
pH Electrodes	General Purpose, Glass, Combination, Specialized	pH range, temperature resistance, chemical compatibility, application type	Food, pharma, water treatment, agriculture, chemical processing	Clean with distilled water or mild solution; rehydrate in pH buffer (pH 4 or 7); store in storage solution (not distilled water)
Conductivity Electrodes	Two-electrode (low conductivity), Four-electrode (high conductivity)	Conductivity range, material compatibility, electrode geometry	Water treatment, environmental monitoring, chemical production, food industry	Rinse with distilled water; clean with mild detergent if needed; periodically check calibration
ORP Electrodes	Platinum, Gold, Graphite	Chemical environment, temperature resistance	Water quality, chemical processing, biological applications	Clean with mild soap and water; polish electrode surface if needed; store in neutral solution or protective case
DO Electrodes	Galvanic (self-polarizing), Polarographic (external power, quick response)	Measurement range, sample environment, electrode configuration	Wastewater treatment, aquaculture, environmental monitoring, pharma	Clean membrane regularly; replace membrane/electrolyte as needed

Dos and Don'ts

Dos	Don'ts
Calibrate regularly for accuracy	Avoid using outside the specified range
Clean after use to prevent contamination	Don't let pH electrodes dry out
Store properly following manufacturer guidelines	Avoid exposure to harsh chemicals unless designed for it
Monitor for wear, cracks, or buildup	Don't store electrodes in distilled water long-term

By selecting the right electrode, maintaining it properly, and following best practices, you ensure accurate measurements and a longer lifespan for your sensors.



Water Distillation Unit

General laboratory applications requiring higher ionic purity, samples & buffer preparations

On Demand Single Distillation Unit (SDU)

Single Stage Distillation units provide automatic working for getting pure water by distillation method capable of removing a wide spectrum of impurities. Raw water is boiled to produce steam which is taken to a condenser where it returns to the liquid state, free of impurity. The impurities remain in the boiler and can be removed periodically with the help of in built descaling or cleaning guide.



Technical Data & Ordering Information

Model Name	SDU1500	SDU2500	SDU4000
Capacity Distilled Water Output	1.5 LPH	2.5 LPH	4 LPH
Minimum cooling water requirement (Ltr/min)	1	1.5	2
Heater	Quartz	Quartz	Quartz
Boiler	Boro 3.3	Boro 3.3	Boro 3.3
Condenser	Boro 3.3	Boro 3.3	Boro 3.3
Biological Activity	Pyrogen Free	Pyrogen Free	Pyrogen Free
Conductivity S/cm*	<3 × 10 ⁻⁶	<3 × 10 ⁻⁶	<3 × 10 ⁻⁶
Power consumption (kw)	1.7 kW	2.5 kW	3 kW
Voltage (V)	230 V	230 V	230 V
Dimensions (L × B × H) in mm	650 × 320 × 440 mm		
HSN Code	84198990		
Ordering Code	BLFRSDU15000000000	BLFRSDU25000000000	BLFRSDU40000000000
Prices / Piece	49,240.00	68,700.00	76,330.00

* Inlet water TDS < 100 ppm

* The specified distillate quality is achieved by using treated water as boiler feed and collecting the distillate in a sealed quartz container to prevent CO₂ exposure.

Spares & Accessories refer page - 295

Note: Because of difficulties associated with measurement of the pH value of high purity water and the doubtful significance values obtained, limits for the pH value of grade 1 & grade 2 water have not been specified. Conductivity specified applies for freshly prepared water in absence of Carbon Dioxide at 20° C.

Water Distillation Unit

General laboratory applications requiring higher ionic purity, samples & buffer preparations

On Demand Double Distillation Unit (DDU)

Double Stage Distillation Units provide automatic working for getting pure water by distillation method capable of removing a wide spectrum of impurities. Raw water is boiled to produce steam which is taken to a condenser where it returns to the liquid state, free of impurity. The impurities remain in the boiler and can be removed periodically with the help of in built descaling or cleaning guide.



Technical Data & Ordering Information

Model Name	DDU1500	DDU2500	DDU4000
Capacity Distilled Water Output	1.5 LPH	2.5 LPH	4 LPH
Minimum cooling water requirement (Ltr/min)	1	1.5	2
Heater	Quartz	Quartz	Quartz
Boiler	Boro 3.3	Boro 3.3	Boro 3.3
Condenser	Boro 3.3	Boro 3.3	Boro 3.3
Biological Activity	Pyrogen Free	Pyrogen Free	Pyrogen Free
Conductivity S/cm*	<3 × 10 ⁻⁶	<3 × 10 ⁻⁶	<3 × 10 ⁻⁶
Power consumption (kw)	3 kW	4.4 kW	6 kW
Voltage (V)	230 V	230 V	230 V
Dimensions (L × B × H) in mm	650 × 550 × 520 mm		
HSN Code	84198990		
Ordering Code	BLFRDDU15000000000	BLFRDDU25000000000	BLFRDDU40000000000
Prices / Piece	77,830.00	1,26,210.00	1,37,280.00

* Inlet water TDS < 100 ppm

* The specified distillate quality is achieved by using treated water as boiler feed and collecting the distillate in a sealed quartz container to prevent CO₂ exposure.

Spares & Accessories refer page - 295

Note: Because of difficulties associated with measurement of the pH value of high purity water and the doubtful significance values obtained, limits for the pH value of grade 1 & grade 2 water have not been specified. Conductivity specified applies for freshly prepared water in absence of Carbon Dioxide at 20° C.

Quartz Cabinet Distillation

On Demand Quartz Double Distillation Unit (QCD)

Double Stage Quartz cabinet units with reservoir provide automatic working with safety cut-offs for dry-run/unstable water flow. It also offers dispensing serially or continuously from reservoir storage.



Technical Data & Ordering Information

Model Name	QCD 250
Orientation	Vertical
Design	Bench Top Cabinet
Capacity Distilled water Output	2.5 LPH
Minimum cooling water requirement (Ltr/min)	2
Dimensions (L*B*H) along with reservoir	730 × 500 × 1020
Heater	Quartz
Boiler	Quartz
Condensor	Quartz
Biological Activity	Pyrogen Free
Conductivity S/cm*	<1 × 10 ⁻⁶
Power consumption (kw)	4 kW
Voltage (V)	230 V
Dry Run Protection	Yes
On Demand Output	Yes
Storage Mode	Yes
Auto Filling Reservoir	Yes
Dispense Range (minimum ml)	10 ml
Order Code	BLFRQCD25000000000
HSN Code	84194090
Prices / Piece	3,09,500.00

*1 Inlet water TDS < 100 ppm

* The specified distillate quality is achieved by using treated water as boiler feed and collecting the distillate in a sealed quartz container to prevent CO₂ exposure.

Note: Because of difficulties associated with measurement of the pH value of high purity water and the doubtful significance values obtained, limits for the pH value of grade 1 & grade 2 water have not been specified. Conductivity specified applies for freshly prepared water in absence of Carbon Dioxide at 20°C. Conductivity values are affected by temperature and absorbed carbon dioxide quantity along with other contaminants from containers stored.

Water Distillation Unit

Manufactured from quartz, providing quick & continuous purified water with smaller foot print in laboratories.

Mono Quartz Distillation Units (Manual)

These Innovative and compact vertical Distillation Units Made from Pure Silica - Quartz are ideal choice for getting single stage distilled water. It meets the standard of the analytical laboratory where purity of distilled water free from metallic ions and bacteria is important.



Technical Data & Ordering Information

Model Name	3363042	3363033	3363038	3364042	3364033
Capacity Distilled Water Output	2.5 LPH	5 LPH	10 LPH	2.5 LPH	5 LPH
Minimum cooling water requirement (Ltr/min)	1	2	2.5	1	2
Heater	Quartz	Quartz	Quartz	Quartz	Quartz
Boiler	Quartz	Quartz	Quartz	Quartz	Quartz
Condenser	Boro 3.3	Boro 3.3	Boro 3.3	Quartz	Quartz
Biological Activity	Pyrogen Free	Pyrogen Free	Pyrogen Free	Pyrogen Free	Pyrogen Free
Conductivity S/cm*	<3 × 10 ⁻⁶	<3 × 10 ⁻⁶	<3 × 10 ⁻⁶	<3 × 10 ⁻⁶	<3 × 10 ⁻⁶
Power consumption (kw)	2.2 kW	4.4 kW	8.8 kW	2.2 kW	4.4 kW
Voltage (V)	230 V	230 V	230 V - 3Phase	230 V	230 V
HSN Code	841940901				
Ordering Code	BT533363042	BT533363033	BT533363038	BT533364042	BT533364033
Model Prices / Piece	48,700.00	92,240.00	2,10,700	84,070.00	1,61,250.00
Accessory - DAPS Code	3366342	3366333	3366338	3366442	3366433
DAPS Prices / Piece	16,880.00	18,850.00	34,910.00	16,880.00	18,730.00

* Inlet water TDS < 100 ppm

* The specified distillate quality is achieved by using treated water as boiler feed and collecting the distillate in a sealed quartz container to prevent CO₂ exposure.

Spares & Accessories refer page - 295

DAPS - The Unit provides for Automatic working of distillation unit by switching off the heaters in case water level falls below the heating coil, thereby safeguarding the heaters. The unit resumes distillation when water level is restored by pushing reset button on front panel. The water level sensor probe works on 12 V and hence is very safe to handle. The unit also comes with Buzzer. DAPS is unique for each model.

Note: Because of difficulties associated with measurement of the pH value of high purity water and the doubtful significance values obtained, limits for the pH value of grade 1 & grade 2 water have not been specified. Conductivity specified applies for freshly prepared water in absence of Carbon Dioxide at 20°C.

Water Distillation Unit

All quartz innovative & compact design offers consistent purified water in two distillation stages

All Quartz Double Distillation Units

Quartz distillation units are manufactured from fused quartz tubes. The exceptionally high chemical purity and very low solubility of this material enables the production of very high performance system. The greatest possible attention has been taken for technical performance, simplicity of use and efficiency.



Technical Data & Ordering Information

Model Name	3365041	3365042	3365033
Capacity Distilled Water Output	1.5 LPH	2.5 LPH	5 LPH
Minimum cooling water requirement (Ltr/min)	1	2	2.5
Heater	Quartz	Quartz	Quartz
Boiler	Quartz	Quartz	Quartz
Condenser	Quartz	Quartz	Quartz
Biological Activity	Pyrogen Free	Pyrogen Free	Pyrogen Free
Conductivity S/cm*	<1 × 10 ⁻⁶	<1 × 10 ⁻⁶	<1 × 10 ⁻⁶
Power consumption (kw)	3 kW	4.4kW	8.8 kW
Voltage (V)	230 V	230 V	230 V - 3 Phase
HSN Code		84194090	
Ordering Code	BT533365041	BT533365042	BT533365033
Model Prices / Piece	1,39,860.00	2,45,960.00	4,37,740.00
Accessory - DAPS	3366541	3366542	3366533
DAPS Prices / Piece	17,930.00	18,730.00	35,370.00

* Inlet water TDS < 100 ppm

* The specified distillate quality is achieved by using treated water as boiler feed and collecting the distillate in a sealed quartz container to prevent CO₂ exposure.

Spares & Accessories refer page - 295

DAPS - The Unit provides for Automatic working of distillation unit by switching off the heaters in case water level falls below the heating coil, thereby safeguarding the heaters. The unit resumes distillation when water level is restored by pushing reset button on front panel. The water level sensor probe works on 12 V and hence is very safe to handle. The unit also comes with Buzzer. DAPS is unique for each model.

Note: Because of difficulties associated with measurement of the pH value of high purity water and the doubtful significance values obtained, limits for the pH value of grade 1 & grade 2 water have not been specified. Conductivity specified applies for freshly prepared water in absence of Carbon Dioxide at 20°C.

Accessories for Distillation Units

On Demand Glass Distillation Units Spares

Product Code	Description	Prices
BLAPSDU1500BOIL000	WDU 1.5LTR BOILER ACCS	9,870.00
BLAPSDU2500BOIL000	WDU 2.5LTR BOILER ACCS	12,030.00
BLAPSDU4000BOIL000	WDU 4.0LTR BOILER ACCS	15,210.00
BLA0CRH12KW15LHQRT	Ceramic Heater_ Quartz tube-1.5 L Accs	9,870.00
BLA0CRH02KW25LHQRT	Ceramic Heater_ Quartz tube-2.5 L Accs	10,780.00
BLA0CRH03KW04LHQRT	Ceramic Heater_ Quartz tube-4 L Accs	14,530.00
BLAPSDU1500CON0000	1.5 LTR CONDENSER ACCS	7,040.00
BLAPSDU2500CON0000	2.5 LTR CONDENSER ACCS	10,780.00
BLAPSDU4000CON0000	4.0 LTR CONDENSER ACCS	12,940.00
BT603367000	WATER SOFTNER	30,970.00

Mono Quartz Units Spares

Product Code	Description	Prices
BT530363012	QUARTZ BOILER FOR DIST UNIT-3363/64 2.5 L	33,800.00
BT530363032	QUARTZ BOILER FOR DIST UNIT-3363/64 5 L	66,460.00
BT530363502	QUARTZ BOILER FOR DIST UNIT-3363 10 L	1,16,470.00
BT530362022	BOROSILICATE CONDENSER 3363 2.5 L	6,470.00
BT530363500	BOROSILICATE CONDENSER 3363 5 LTR	22,000.00
BT530363503	BOROSILICATE CONDENSER 3363 10 LTR	44,460.00
BT530364023	QUARTZ CONDENSER 3364 2.5 L	33,570.00
BT530364501	QUARTZ CONDENSER 3364 5 LTR	77,120.00

All Quartz Double Distillation Spares

Product Code	Description	Prices
BT530362013	PRIMARY BOILER 1.5 L FOR DISTUNIT-3365	42,760.00
BT530362014	PRIMARY BOILER FOR DIST UNIT-2.5 LT-3365	43,560.00
BT530362504	PRIMARY BOILER 3365 5 LTR/HR	68,390.00
BT530362015	SECONDARY BOILER 1.5 LTR/HR.	1,08,870.00
BT530362016	SECONDARY BOILER 2.5 LTR/HR	1,51,510.00
BT530363505	SECONDARY BOILER 3365 5 LTR/HR	2,92,690.00
BT530362063	RECEIVING ADAPTER WITH SPRING	2,390.00
BT530362052	SILICONE 'O' RING FOR DIST UNIT - 3365	800.00

All Glass Manual Units

Product Code	Description	Prices
BT530336011	BORO BOIL WTR LVL FOR DISUN 3361/62 1.5 L	8,170.00
BT530336031	BOROSILICATE BOILER B-45 WATER LEVELLER	11,580.00
BT530336021	BOROSILICATE BOILER W/O HEATER 4 LTR	20,080.00
BT530336012B	QUARTZ HTR B-34 BLUE FOR DISUNIT 3361/62	8,170.00
BT530336012R	PRIMARY QUARTZ NEW TYPE HEATER B-34	8,170.00
BT530336013B	SECONDARY QUARTZ NEW TYPE HEATER B-45	11,340.00
BT530336013R	PRIMARY QUARTZ NEW TYPE HEATER B-45	11,340.00
BT530336022B	SECONDARY QUARTZ NEW TYPE HEATER B-50 4 L	14,180.00
BT530336022R	PRIMARY QUARTZ NEW TYPE HEATER B-50 4 LT	14,180.00
BT530361021	COND FOR DIST. UNIT - 3361,3362 1.5 L	6,470.00
BT530361041	COND FOR DIST. UNIT - 3361,3362 2.5 L	11,240.00
BT530362021	COND FOR DIST. UNIT - 3361,3362 4.0 L	17,130.00

Silicone Tubing

Product Code	Description	Prices
BT603369001	Silicon tubing 4 mm x 7 mm	2150.00
BT603369002	Silicon tubing 6 mm x 9 mm	2860.00
BT603369003	Silicon tubing 8 mm x 12 mm	5830.00
BT603369004	Silicon tubing 10 mm x 14 mm	7130.00

Lab Essentials & Synthesis Equipment

Precision and reliability are at the core of every successful laboratory. Our range of Water Distillation Units, Baths & Circulators, Laboratory Stirrers, Heating Mantles, Vacuum Pumps, and Glass Dryers is designed to support critical synthesis and analytical processes. Engineered for accuracy, efficiency, and durability, these instruments ensure optimal performance in research and industrial applications. Enhance your workflow with cutting-edge solutions that meet the highest quality standards.



WATER DISTILLATION UNIT

On-Demand Output

Sequential dispensing



WATER BATHS

Seamless, SS304 Construction
Delay start function

Available with data logging

For more details

Please contact CT Enterprises for quotation.

Email: sales@ctenterprises.in | Phone: +91 8977721310



MANTLES

CE certified

Built-in spillage protection

Effortless setup for convenient use



STIRRERS

Dedicated displays for Temperature and RPM/Time

Precise control over solution temperature Pt100



LABWARE DRYER

Quick and Efficient Drying

compact and efficient design

Please contact CT Enterprises for quotation.

Email: sales@ctenterprises.in | Phone: +91 8977721310

ACTICAL

Water Baths

Borosil Labquest Premium range of circulating water baths are an ideal choice when temperature uniformity and control are particularly critical along with Data logging connectivity.

Premium Series - Circulating Water Bath

Labquest Premium baths provide more uniform heat convection. These Heating baths are particularly useful in Routine lab applications, Coliform determinations, Sample thawing, Bacteriological examinations, Microbiological assays, Cell cultivation.



Technical Data & Ordering Information

Model Name	WBP012	WBP015	WBP020
Nominal Capacity	12 L	15 L	20 L
Working Temperature Range	Ambient +5 to 99°C	Ambient +5 to 99°C	Ambient +5 to 99°C
Temperature Accuracy at 37°C	±0.2°C	±0.2°C	±0.2°C
Circulation	By PTFE Stir Bar	By PTFE Stir Bar	By PTFE Stir Bar
Interior Dimension (L × B × H) in mm	330 × 300 × 150 mm	330 × 300 × 200 mm	500 × 300 × 150 mm
Exterior Dimension (L × B × H) in mm	400 × 390 × 300 mm	400 × 390 × 350 mm	575 × 390 × 300 mm
Electrical Requirements	5 A	5 A	10 A
Power Consumption	900 W	900 W	2000 W
External Temperature Probe	PT1000	PT1000	PT1000
USB Interface - Data Logging	USB	USB	USB
Lid Type	SS Lid with 6 position Concentric Rings	PC Lid	SS Lid with 8P Lid position Concentric Rings
HSN Code	84198990		
Ordering Code	BLFHWP01200000000	BLFHWP01500000000	BLFHWP02000000000
Prices / Piece	74,250.00	80,410.00	1,05,160.00

High Capacity Baths

Model Name	WBP024	WBP035	WBP060
Nominal Capacity	24 L	35 L	60 L
Working Temperature Range	Ambient +5 to 99°C	Ambient +5 to 99°C	Ambient +5 to 99°C
Temperature Accuracy at 37°C	±0.2°C	±0.2°C	±0.2°C
Circulation	By PTFE Stir Bar	By PTFE Stir Bar	By PTFE Stir Bar
Interior SS304 Dimension (L × B × H)	500 × 300 × 200 mm	625 × 500 × 150 mm	625 × 500 × 200 mm
Exterior SS304 Dimension (L × B × H)	575 × 390 × 350 mm	675 × 550 × 300 mm	675 × 550 × 350 mm
Electrical Requirements	10 A	16 A	24 A
Power Consumption	2000 W	3000 W	4400 W
External Temperature Probe	PT1000	PT1000	PT1000
USB Interface - Data Logging	USB	USB	USB
Lid Type	SS Lid with 8 position Concentric Rings	SS Canopy	SS Canopy
HSN Code	84198990		
Ordering Code	BLFHWP02400000000	BLFHWP03500000000	BLFHWP06000000000
Prices / Piece	On Request	On Request	On Request

Data Logger

Measure & Record progress of set parameters

- Labquest instruments with USB connectivity e.g. Industrial Stirrers and Premium Water Baths facilitate data logging.
- Borosil Data Logger continuously monitors and records the activity performed by connected instruments over a period of time. Users can take the print out for specified period and operation.
- PNP010 a reliable, cost and time-efficient monitoring solution for any measuring & recording progress of set parameters offering key advantages by providing high accuracy and ease of use.



Key Features

Records user level activity with Instrument attached

Login feature supports administrator and up to 99 users with display 128x64 GLCD

Any time print option for logged data records

Customizable print format with company name, lab/department name and process parameters

Technical Data & Ordering Information

Ordering Code	Prices / Piece
BLFAPNP0100000000	On request

Water Baths

The Elemental Series of general purpose Water Baths offers variety of sizes to meet all your needs and is ideal for lab applications.

CE Certified Elemental Series - Constant Temperature Baths

Elemental Series Water Baths can be used for a wide variety of purposes, including routine laboratory tasks, holding samples at a constant temperature, incubation, materials testing, corrosion testing, temperature control of cultures, thermal testing of food and dental applications. In this series temperature uniformity is obtained by convection gradually.



Technical Data & Ordering Information

Model Name	WLC005	WLC012	WLC020
Nominal Capacity	5 L	12 L	20 L
Working Temperature Range	Ambient \pm 5 to 99°C	Ambient \pm 5 to 99°C	Ambient \pm 5 to 99°C
Temperature Accuracy at 37°C	\pm 0.5°C	\pm 0.5°C	\pm 0.5°C
Circulation		By Convection Only	
Interior Dimension (L x B x H) in mm	300 x 150 x 150	330 x 300 x 150	500 x 300 x 150
Exterior Dimension (L x B x H) in mm	330 x 175 x 300	375 x 340 x 300	540 x 340 x 300
Power Consumption	3.5 A, 230 V, 700 W	8 A, 230 V, 1600 W	9.5 A, 230 V, 2000 W
HSN Code	84198990		
Ordering Code	BLFHWLC00500000000	BLFHWLC01200000000	BLFHWLC0200000000
Prices / Piece	40,110.00	48,300.00	56,180.00

Optional Accessories

Model Name	Ordering Code	Suitable For	Prices / Piece
3 Hole SS LID Assembly	BLAHWLC005LID00003	WLC005	2,940.00
5L Polycarbonate LID Assembly	BLAHWLC005PCLID000	WLC005	4,520.00
6 Hole SS LID Assembly	BLAHWLC012LID00006	WLC012	4,100.00
12/15 Polycarbonate LID Assembly	BLAHWLC012PCLID000	WLC012	5,360.00
8 Hole SS LID Assembly	BLAHWLC020LID00008	WLC020	5,570.00
12 Hole SS Lid Assembly	BLAHWBA02000000012	WLC020	9,450.00
20 Ltr Polycarbonate Lid ASM	BLAHWBA020CAPPC000	WLC020	7,460.00
Ball Shield Anti-evaporation Spheres (Ø37mm x 500 nos)	BLAHWLS020BALLID00	All Baths	9,020.00
WLC005 SS CANOPY ACCS	BLAHWLC005500000000	WLC005	12,040.00
WLC012 SS CANOPY ACCS	BLAHWLC012500000000	WLC012	13,510.00
WLC/20/24 SS CANOPY ACCS	BLAHWBP024600000000	WLC020	15,000.00
WBP060 24 POSITION SS304-LID ACCS	BLAHWBP060LID000025	WBP35/60	15,650.00
Universal Height Adjustment Tray	BLAHWBP035600000000	WBP35	17,050.00
*2 Hole SS LID Assembly	BLAHWLS005LID00002	WLS005	3,410.00
*6 Hole SS LID Assembly	BLAHWLS012LID00006	WLS012	4,620.00
*8 Hole SS LID Assembly	BLAHWLS020LID00008	WLS020	6,300.00
*Overhead Stirrer Assembly for conversion for WLC Models to WLS	BLAHWLS020000000OHS	All Baths	8,610.00

Note : Please check (*) accessories to convert WLC (Constant Temperature Bath) into the WLS series of stirred bath for enhanced functionality

Oil Baths

Precision Oil bath build in 100% SS offers controlled heating upto 240°C.

Still & Stirred Oil Baths

Precision oil baths for controlled heating & tempering applications with a temperature accuracy of + 1°C and a built in 100% SS construction. Baths are insulated for user protection and equipped with overshoot control. Baths can also be used with water.



Technical Data & Ordering Information

Model Name	OMC250	OMC010
Working Temperature Range	Ambient +5°C to 240°C	
Circulation	Convection	
Nominal Capacity	750 ml	3057 ml
RB Flask	250 ml	1000 ml
Interior Dimension (D × H) in mm	120 × 86	182 × 142
Exterior Dimensions (L × B × H) in mm	203 × 169 × 209	273 × 240 × 263
Power Consumption	350 W	1000 W
HSN Code	84198990	
Ordering Code	BLFHOMC25000000000	BLFHOMC01000000000
Prices / Piece	35,650.00	41,400.00

*Interior tanks are cylindrical in shape.

Technical Data & Ordering Information

Model Name	OMS250	OMS010	OMS020
Working Temperature Range	Ambient +5°C to 240°C		
Circulation	PTFE Stir Bar		
Nominal Capacity	750 ml	3057 ml	7500 ml
RB Flask	250 ml	1000 ml	2000 ml
Interior Dimension (D × H) in mm	120 × 86	182 × 142	217x 209
Exterior Dimensions (L × B × H) in mm	203 × 169 × 209	273 × 240 × 263	302 × 280 × 410
Power Consumption	350 W	1000 W	1600 W
HSN Code	84198990		
Ordering Code	BLFHOMS25000000000	BLFHOMS01000000000	BLFHOMS02000000000
Prices / Piece	40,020.00	59,850.00	1,00,170.00

Mini Lab Reactor

Mini Lab Reactor is available with a multi-neck round bottom flask, optimized for academic and research applications. It is a cost-effective solution that includes an oil bath-based heating that eliminates the need for an external heating system. We provide electronic control for temperature, speed, time, and step reaction. We provide optional cooling to prevent reaction runaway in case of an exothermic reaction. We supply explosion-proof variants for critical applications on special request.



- SS Body Oil bath with Drain Valve
- Non Sparking stirrer Drive
- Effortless height Adjustment
- SS Body Oil bath with Drain Valve

This series reactors is the ideal instrument in experiments and manufacturing of modern chemistry, fine chemical engineering, bio-pharmaceuticals and new material synthesis.

Technical Data & Ordering Information

Model Name	MLR250	MLR500	MLR010
RB Reactor Capacity	250 ml	500 ml	1000 ml
Number of Necks*	1 CN, 4 SN		
Heating Bath Volume	5 L		
Temperature Range#	-10°C to 200°C		
Condenser	Double Coil Condenser		
Feed Funnel	Pressure Equalizing		
Receiver Vessel	500ml with Round bottom		
Temperature sensor with glass thermovalve	Yes	Yes	Yes
Hot Bath Drain	Yes (SS)		
Absolute mBar(Pressure)	100-1000 mBar	100-1000 mBar	100-1000 mBar
Vaccum mBar	100-1000 ml		
Stirring Speed(rpm)	150-1000 rpm		
impeller	PTFE coated centrifugal	PTFE coated centrifugal	PTFE coated centrifugal
Stirring Power	24 W	24 W	24 W
Agitator	Centrifugal desgin BLDC, SS304 coated with reinforced PTEE Shaft Dia8mm X350mm Ht		
Power	1 kW, 230 V 50 Hz		
Control Unit	Temperature / RPM control Unit with LED Display		
7 seg digital LED controller	YES		
Dimension of Unit MLR	470 × 300 × 750 mm		
Product Codes	BLFHMLR25000000000	BLFHMLR50000000000	BLFHMLR01000000000
HSN			
Prices / Piece	On Request		

* RB Standard Neck sizes Applicable

For Exothermic Recations below RT - External Chiller Needs to be attached. See our Chiller Range

For better enhanced performance we recomand chillers CHL010 and CHL020

Accessories

Technical Data & Ordering Information

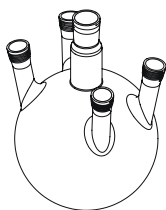

Part Numbers	Description	Volume Capacity (mL)	No of Nozzles	Center Nozzle Type	Side Nozzle Type	Suitable Model
BLARMLRFLSK250MLV3	Flat Bottom Flask	250	5	B24	B19	MLR250
BLARMLRFLSK500MLV3		500	5	B24	B19	MLR500
BLARMLRFLSK1000LV3		1000	5	B24	B19	MLR010

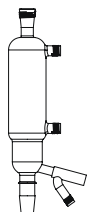

Part Number	Description	Size	HT area	Connection nozzle size	Suitable Model
BLARCND000D060L320	Condenser	D60 LEN 320	0.05	19/22	All Models
BLARCND000D050L260		D50 LEN 260	0.03	19/22	All Models

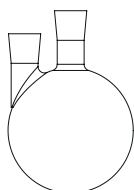

Part Number	Description	Volume Capacity (mL)	Center Nozzle	Side Nozzles	Suitable Model
BLARREFBTV0500MLV2	Collector Flask	500 mL	19/22	19/22	All Models

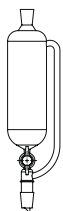

Part Number	Description	Volume Capacity	Connection Nozzle Size	Suitable Model
BLARDOF00250MLCOCK	Feed Funnel	250 mL	19/22	All Models
BLARDOF00100MLCOCK		100 mL	19/22	All Models

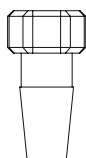

Part Number	Description	Size	Suitable Model
BLARSTP00019220000	Glass Stopper	B19	AllModels
BLARSTP00024290000		B24	AllModels

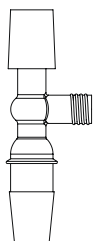

Part Number	Description	Nozzle Size	Suitable Model
BLARADP0BC1922COCK	Bent Adapter	B19	All Models

Part Number	Description	Nozzle Size	Suitable Model
BLARCSTSWNCK1922V1	Swan Neck	B19	All Models

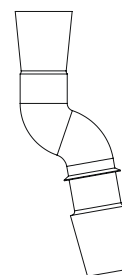

Part Number	Description	Nozzle Size	Suitable Model
BLARADP0BC1922GL14	Straight Adopter	B19 / GL14 Thread	AllModels



Part Number	Description	Size	Suitable Model
BLAATEMPPOB10OD200	Temperature Probe Pocket	12 mm	AllModels

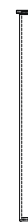

Part Number	Description	Size	Suitable Model
BLARCAPGL25PTFE001	GL Caps	GL25	AllModels
BLARCAPGL32PTFE001		GL32	AllModels

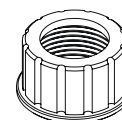

Part Number	Description	Size
BLARMBR00126000000	GL Barb Connector	GL14

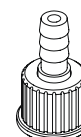

Part Number	Description	Size
BLA0ROT102DX16ODSS	Universal Coupling	8 mm Id



Ultrasonic Baths

Ultrasonic Bath offers gentle effective cleaning action ensuring that no contaminants get carried over from the previous process.

Sonicator Bath

Ultrasonic Baths use sound waves and liquid to clean small objects. Borosil Labquest digital series of Ultrasonic cleaners come in four different sizes. These stainless steel cleaners feature a bright LED display for time and temperature and easy push-button control along with 'degas' functions.



Technical Data & Ordering Information

Model Name	UCB025	UCB050	UCB100	UCB200	UCB270
Capacity	1.5 L	5 L	10 L	20 L	25 L
Working Temperature Range	Ambient +5 °C to 80°C				
Frequency	40 kHz				
Time setting	1- 99 mins				
Interior Dimension (L × B × H) in mm	150 × 140 × 100	300 × 155 × 150	300 × 240 × 150	500 × 300 × 150	500 × 300 × 200
Exterior Dimension (L × B × H) in mm	190 × 170 × 220	330 × 180 × 330	330 × 270 × 330	550 × 330 × 330	550 × 330 × 280
Ultrasonic Power	50 W	150 W	200 W	400 W	360 W
Heater Power	100 W	300 W	500 W	500 W	500 W
HSN Code	84798999				
Ordering Code	LQLEUCB 02500000000	LQLEUCB 05000000000	LQLEUCB 10000000000	LQLEUCB 20000000000	LQLEUCB 270HD0000000
Prices / Piece	31,100.00	47,900.00	78,900.00	1,02,100.00	1,55,000.00

Recirculating Chillers

Labquest state-of-the-art Chillers ensure accurate alignment and constant conditions of instruments even in the challenging laboratory conditions. Recirculating chillers offer multiple benefits, including reducing user costs, protecting the environment, improving reaction reproducibility.

Cooling & Heating Circulators

Routine laboratory applications involving rotary evaporators, soxhlet & lab distillations, jacketed reactors, solvent tanks, Warming reagents, vacuum systems, and even analytical instruments.



Recirculating Chiller

Technical Data & Ordering Information

Model Name	CHL175	CHL250	CHL500	CHL010	CHL020
Tank capacity	5 L	5 L	5 L	8 L	15 L
Tank size (L × B × H) mm	325 × 176 × 150	325 × 265 × 150	325 × 265 × 150	325 × 265 × 200	375X300X250
Overall Dimensions (L × B × H) mm	508 × 257 × 596	954 × 327 × 596	594 × 327 × 596	594 × 396 × 723	700X550X700
Cooling capacity	175 W	250 W	500 W	1000 W	2000 W
Pump flow rate	12.5 LPM	12 LPM	15 LPM	15 LPM	15 LPM
Display	LED	LED	LED	LED	LED
Temperature stability	± 1.0 °C	± 1.0 °C	± 1.0 °C	± 1.0 °C	± 1.0 °C
Temperature range	-20 °C to ambient -5 °C	-20 °C to ambient -5 °C	-20 °C to ambient -5 °C	-20 °C to ambient -5 °C	-20 °C to ambient -5 °C
Castor Wheels for Mobility	NA	NA	Yes	Yes	Yes
HSN Code	84798999				
Ordering Code	BLFRCHL 17500000000	BLFRCHL 25000000000	BLFRCHL 50000000000	BLFRCHL 01000000000	BLFRCHL 02000000000
Prices / Piece	On Request	On Request	On Request	On Request	On Request

Recirculating Heater / Chiller

Technical Data & Ordering Information

Model Name	CTR010
Tank capacity	8 L
Tank size (L × B × H) mm	325 × 265 × 200
Overall Dimensions (L × B × H) mm	594 × 396 × 723
Cooling capacity	1000 W
Pump flow rate	12.5 LPM
Heater Capacity	1200 W
Display	LED
Temperature stability	± 1.0 °C
Temperature range	-10 °C to +100 °C
Castor Wheels for Mobility	YES
HSN Code	84798999
Ordering Code	BLFRCTR01000000000
Prices / Piece	On Request

Laboratory Stirrers

Compact magnetic stirrer with digital display offering accurate speed, timer, temperature setting

Magnetic Stirrers - Heat & Stir applications

These stirrers offer accurate, stable and highly-reproducible in various heating & stirring experiments involving low viscous fluids.



Technical Data & Ordering Information

Model Name	HLS200P	MHPS550P Premier
Stirring Position	1	1
Max Capacity	2 L	20 L
Max Speed for H ₂ O	1500 rpm	up to 2200
Timer	0 - 999 min OR Continuous	0 - 999 min OR Continuous
Plate Temperature	Ambient - 300 °C	Ambient +5 °C - 550 °C
Safe Temperature Setting	Yes	Yes
Hot Indicator when Plate is above 50 °C	Yes	Yes
Pulse Mode	NA	Yes
Display	LED Digital	Dual Set & Actual Temp, RPM & Time
Plate Material	SS 304	Ceramic
Power Consumption	2Å, 230V, 300	5Å, 230V, 1000W
Magnetic Bar	25 mm	25 mm
Top Plate Dimensions (L × B) in mm	150 × 155	180 × 180
Product Dimensions (L × B × H) in mm	285 × 190 × 150	313 × 212 × 110
Protection Class	IP21	IP21
Supplied with	PT100 Probe only	PT1000 Probe & Stand
HSN Code	84798200	
Ordering Code	BLFHLS200P0000000	100MHPS010550P
Prices / Piece	19,100.00	61,530.00

Optional Accessories

Description	Ordering Code	Suitable for
PT100 DIN Connector	BLA0DIN00MX0005PIN	HLS200P
PT1000 Probe	100MHPS01PT100	MHPS550P Premier
Probe Stand	100MHPS01PS000	MHPS550P Premier

Note: 100MHPS0103500 model is also available, till stocks last. (P.O.R.)

Hot Plate Stirrer

**COMING
SOON**



* Retort Stand not included in package

Technical Data & Ordering Information

Model Name	HPS500
Stirring Positions	1
Max Capacity	5 L
Max Speed for H ₂ O	1500
Timer	upto 99 hrs 99 min or Continuous Mode
Plate Temperatures upto °C	350 °C
Temperature Accuracy	Operation with external temperature measuring sensor Pt1000: ± 0.5 K
Safe Temperature Setting	Yes
Hot Indicator when Plate is above 50 °C	Yes
Display	3.5" TFT Display
Temperature Increments	Yes
Stirring RPM Increments	Yes
Top Plate Material	Stainless Steel
MOC Body	Aluminium
Power Consumption	1.5 kW
Magnetic Bar	Yes
Top Plate Dimensions	∅168 mm
Safety Warning for Plate Temp above 50 °C	Yes
IP Protection Class	IP21
External Temperature Probe 1	PT1000 Probe
External Temperature Probe 2	PT100 Probe
Rotation speed range	200 – 1500 rpm
Overhead Stirrer speed range	50 – 1000 rpm
Heating power	1000 watts @ 230 V
Temperature range	RT – 350 °C, setting accuracy 0.1 °C for Plate
Heating control	PID
Power input	230 V, 50 Hz, 6 A
Product Dimensions (L × B × H) in mm	360 × 215 × 160 mm (approx)
Ordering Code	BLFHPS50000000000*
Prices / Piece	On Request

Note: Parallel Reaction Station Accessory needs to be procured separately.

Stirrers - Max Stir

Outstanding stirring for high-volume applications in process equipments with USB Data Logging options

Industrial Max Stir MGS Series

Industrial Max-Stir are designed for chemical and biotechnical applications of all kinds that are within the field of quality insurance and pilot plant stations, it can also be integrated with high capacity process equipments, developed for highest demands, unbeatably strong, high stability with uncompromising continuous operation.



Technical Data & Ordering Information

Model Name	MGS020	MGS050	MGS200
Number of stirring positions		1	
Stirring quantity	Upto 20 L	Upto 50 L	Upto 200 L
Motor Type	BLDC 15 motor	BLDC 30 motor	
Stirring bar length	35 - 80 (in mm)	80 - 120 (in mm)	155 (in mm)
Material Housing		304 Stainless steel	
Display	Digital LCD Display		
Speed range	0 - 1000 rpm	0 - 600 rpm	
Timer	(0 - 99:99 hrs:min) or continuous/infinite operation		
Set-up plate dimensions in mm	300 × 300	400 × 400	500 × 500
Dimensions (L × B × H) mm	300 × 390 × 110	400 × 490 × 110	500 × 590 × 110
Weight of the Product	12 Kgs	14 Kgs	25 Kgs
Weight / Load (it can Sustain)	30 Kgs	70 Kgs	70 Kgs
Process Equipments Indirect Load It can stir	Volumes up to 20L	Volumes up to 50L	Volumes up to 200L
Ramp Rate	Adjustable for different viscosity		
USB Interface (Upgradable)	YES - Option to connect Labquest Data Logger & Printer		
Permissible temperature	5 °C to 40 °C		
Max Current	5A	5A	
Motor rating output	30W	60W	
HSN Code	90278090		
Ordering Code	BLFHMG02000000000	BLFHMG05000000000	BLFHMG20000000000
Prices / Piece	On Request		

Stirrers

Compact multiposition magnetic stirrer with digital display offering accurate speed, timer, temperature setting

Magnetic Stirrers with Heating - Multiple Position

Multi-position Hot Plate Magnetic Stirrer is used widely for liquid heating mixing parallel and series of experiments. It is the essential mixing instrument for biology, heredity, medicine and health, environmental protection and biochemistry laboratories.



MHPS 15P

Technical Data & Ordering Information

Model Name	MHPS 5P	MHPS 10P	MHPS 15P
Stirring Position	5	10	15
Plate Temperature	120°C	120°C	120°C
Max Capacity	5 × 250 ml	10 × 250 ml	15 × 250 ml
Max Speed	1500 rpm	1500 rpm	1500 rpm
Timer	1-999 min	1-999 min	1-999 min
Motor Type	BLDC	BLDC	BLDC
Pulse Mode	Yes	Yes	Yes
Display	Digital	Digital	Digital
Plate Material	Stain less steel plate with silicone sheet		
Power Consumption	450 W	450 W	800 W
Magnetic Bar	25 mm	25 mm	25 mm
Top Plate Dimensions (L × B) in mm	565 × 136	565 × 196	565 × 282
Product Dimensions (L × B × H) in mm	565 × 136 × 75	565 × 196 × 75	565 × 282 × 75
Protection Class	IP42	IP42	IP42
HSN Code	84798200		
Ordering Code	100MHPS0515000	100MHPS1015000	100MHPS1515000
Prices / Piece	59,280.00	82,500.00	1,20,490.00



5 position



10 position



15 position

Laboratory Stirrers

Compact magnetic stirrer with digital display offering accurate speed, timer setting

Magnetic Stirrers - Stir only applications

A magnetic stirrer is a laboratory device that employs a rotating magnetic field to cause a stir bar immersed in a liquid to spin very quickly, thus stirring it. It finds applications in chemistry & biology experiments involving Dilution, Maintaining suspensions, Homogenisation and Dissolution, Emulsions in a laboratory.



Technical Data & Ordering Information

Model Name	MGS001	MS One	MS Four	MLS010	MLS050
Stirring Position	1	1	4	1	1
Max Capacity	upto 2L	800 ml	4 × 400 ml	10 L	50 L
Max Speed	2200 RPM	1500 RPM	1200 RPM	upto1000 RPM	upto1000 RPM
Timer	0-999 min	1-99min	1-99min	Continuous	Continuous
Pulse Mode	NA	Yes	Yes	NA	NA
Display	LED	Digital	Digital	LED	LED
Plate Material	SS304	SS304	SS304	SS	SS
Type of Motor	AC	Motorless	Motorless	BLDC	BLDC
Slip Detection	NA	NA	NA	Yes	Yes
Power Consumption	1Å, 230V, 25W	1.5Å, 12V, 5W	2Å, 9V, 13W	1.5Å, 12V, 30W	2Å, 12V, 60W
Magnetic Bar	25 mm	25 mm	25 mm	25, 35, 50, 60	25, 35, 50, 60
Top Plate Dimensions (L × B) in mm	155 × 145	150 × 100	385 × 182	250 × 250	370 × 370
Product Dimensions (L × B × H) in mm	284 × 188 × 120	156 × 110 × 14	457 × 126 × 14	310 × 250 × 100	430 × 370 × 100
Protection Class	IP21	IP65	IP65	IP42	IP42
HSN Code	90278090				
Ordering Code	BLFHMG 001P0000000	100MS0 00115000	100MS0 00412000	BLFHML S01000000000	BLFHML S05000000000
Prices / Piece	10,730.00	17,020.00	33,920.00	40,010.00	61,950.00

Hot Plates

Precise digital temperature control and timer function

Rectangular Hot Plates

Labquest microprocessor PID controlled Hot Plates offers uniform & precise heating along with safe working. It finds applications in acid and base digestions, trace metal analysis, sample drying, general reagent heating, evaporation, cytological & histological studies. These products are widely used in industries such as chemicals, automobile & pharmaceutical laboratories.



HPL400P

HPL020

Technical Data & Ordering Information

Model Name	HPL020	HPL030	HPL400
Max Capacity - Beaker	500ml Beaker × 12 pc	500ml Beaker × 18 pc	2L Beaker × 1 pc
Max Plate Temperature	up to 300°C		
Timer	0-999 min / Continuous	Digital Timer	0-999 min / Continuous
Display	LED	LED Display	LED
Plate Material	Aluminium	Aluminium	SS 304 Top Plate
Power Consumption	2000 W	3000 W	400 W
Energy Regulation	YES		
Top Plate Dimensions (L × B)mm	300 × 450	450 × 600	155 × 150
Product Dimensions (L × B × H) mm	320 × 465 × 215	465 × 615 × 215	285 × 190 × 150
HSN Code	84798200		
Ordering Code	BLFHHPPL02000000000	BLFHHPPL03000000000	BLFHHPPL400P0000000
Prices / Piece	66,040.00	79,810.00	10,730.00

Laboratory Stirrer Accessories

Aluminium Blocks & Stir Bars are basic accessories that promote safe & better heat transfer while using RB Flask or Reaction Tubes on a Hot Plate

Aluminum Heating Blocks

The aluminum heating reaction blocks provides safe working. The accessories blocks are used with various hot plate stirrers & suitably replace oil bath & heating mantles thus promoting safe laboratory working.

Magnetic stir bars in various sizes are also available.

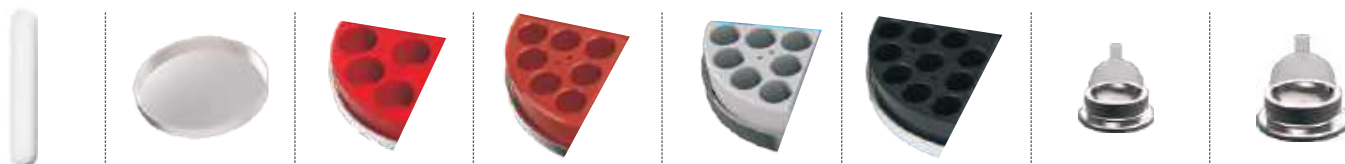

Technical Data & Ordering Information

Model Name	Ordering Code	Pack Size	List Price
Accessory Stir Bar D: 8 mm × 25 mm	100MSA0BL08025	10	4,730.00
Accessory Stir Bar D: 8 mm × 35 mm	100MSA0BL08035	10	5,060.00
Accessory Stir Bar D: 12 mm × 50 mm	100MSA0BL12050	10	14,620.00
Accessory Stir Bar D: 13 mm × 60 mm	100MSA0BL13060	1	2,150.00
Aluminium Blocks Organiser Carry Plate	BLAHHPA00QP000000	1	6,200.00
Aluminium Quarter Block 4 × 20 ml	BLAHHPA00QB200000	1	5,000.00
Aluminium Quarter Block 4 × 30 ml	BLAHHPA00QB300000	1	7,800.00
Aluminium Quarter Block 7 × 16 ml	BLAHHPA00QB160000	1	5,600.00
Aluminium Quarter Block 10 × 8 ml	BLAHHPA00QB080000	1	6,100.00
Aluminium Quarter Block 12 × 4 ml	BLAHHPA00QB040000	1	6,100.00
Aluminium Reaction Block RB 50 ml	BLAHHPA00RB050000	1	9,200.00
Aluminium Reaction Block RB 100 ml	BLAHHPA00RB100000	1	9,200.00
Aluminium Reaction Block RB 250 ml	BLAHHPA00RB200000	1	9,200.00
Aluminium Reaction Block RB 500 ml	BLAHHPA00RB500000	1	9,200.00
PT1000 Probe	100MHPS01PT100	11	9,300.00
Probe Stand	100MHPS01PS000	1	2,450.00

Overhead Stirrer

Labquest by Borosil presents a range of overhead stirrers designed for stirring and mixing tasks in the laboratory, catering to low to high viscosities.

Overhead stirrers are crafted to meet the diverse needs of laboratory applications, providing reliable and efficient solutions for stirring and mixing tasks. BLDC, Microprocessor, Compact, Overload Protection.

- Stirring quantities of up to 100 liters.
- Brushless DC motor
- Micro-processor controlled technology.
- Reversible mixing Motions
- Compact and totally enclosed casing for enhanced safety.
- Adjustable push through impeller shaft to accommodate different heights/vessels
- Internal overload protection for added safety.



Technical Data & Ordering Information

Model Name	OHS15	OHS20	OHS40	OHS50	OHS75	OHS100
Stirring quantity max [L / H ₂ O]	20 L	25 L	40 L	50 L	75 L	100 L
Speed range [rpm]	50-1000	50-2000	50-1000	60-2000	60-2000	60-1300
Max Torque [N-cm]	15 N-cm	20 N-cm	40 N-cm	50 N-cm	75 N-cm	100 N-cm
Max Viscosity	8000mPas	10000mPas	30000mPas	30000mPas	50000mPas	70000mPas
Motor	BLDC	BLDC	BLDC	BLDC	BLDC	BLDC
Power	24V/36 W	24V/36 W	24V/36 W	24V/72 W	24V/72 W	24V/72 W
Change of Rotation Direction	Yes	Yes	Yes	Yes	Yes	Yes
Speed / Timer Display	Digital LED	Digital LED	Digital LED	Digital LED	Digital LED	Digital LED
Impeller Adjustment	Push Through	Push Through	Push Through	Push Through	Push Through	Push Through
Overload Protection	Yes	Yes	Yes	Yes	Yes	Yes
Over Temperature Protection	Yes	Yes	Yes	Yes	Yes	Yes
Auto Resume - Power Interruption	Yes	Yes	Yes	Yes	Yes	Yes
Smart Control Feature	Yes	Yes	Yes	Yes	Yes	Yes
IP Rating	IP54	IP54	IP54	IP42	IP43	IP44
Chuck range diameter [mm]	1-10 mm	1-10 mm	1-10 mm	1-10 mm	1-10 mm	1-10 mm
Timer	1-99min OR Continuous					
Dimensions (L x W x H) [mm]	176X173X79	176X173X79	176X173X79	102X242X249	102X242X249	102X242X249
Weight [kg]	1.7 kg	1.7 kg	1.7 kg	5 kg	5 kg	5 kg
HSN	84798200					

* Chuck, Impellers, stand & boss head clamp to be ordered separately









Overhead Stirrer









Technical Data & Ordering Information

Description	Item code	Price/pc
OHS15 15Ncm 20L 1000RPM 8000mPas	LQLEOHS015020PR000	30,400.00
OHS20 20Ncm 25L 2000RPM 10000mPas	LQLEOHS020025PR000	42,600.00
OHS40 40Ncm 40L 1000RPM 30000mPas	LQLEOHS040040PR000	44,600.00
OHS50 50Ncm 50L 2000RPM 30000mPas	LQLEOHS050050E0000	69,400.00
OHS75 75Ncm 75L 2000RPM 50000mPas	LQLEOHS075075E0000	73,500.00
OHS100 100Ncm 100L 1300RPM 70000mPas	LQLEOHS100100E0000	76,100.00

* Chuck, Impellers, stand & boss head clamp to be ordered separately



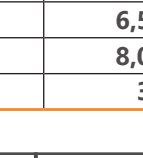

Impellers

Description	Item code	Flow Type	Dia	Max RPM	Viscosity Range	Blade Type	Price/pc
Propeller Impeller (50X8X550 mm)Axial	LQLEOHA5008550PIA0	Axial	50	2000	0-10000		2,300.00
Propeller Impeller (100X15X550 mm)Axial	LQLEOHA10015550PIO	Axial	100	800	0-20000		4,000.00
Propeller Impeller (130X15X800 mm)Axial	LQLEOHA13015800PIO	Axial	130	800	0-30000		5,600.00
CrossWelded Impeller (50X12X550mm)Radial	LQLEOHA5012550CWIO	Radial	50	2000	0-10000		3,400.00
StraightB Impeller (35X12X550mm)Radial	LQLEOHA3512550SBIO	Radial	35	2000	0-10000		3,100.00
StraightB Impeller (50X12X550mm)Radial	LQLEOHA5012550SBIO	Radial	50	2000	0-10000		3,800.00
PivotingB Impeller (60X15X550mm)Radial	LQLEOHA6015550PBIO	Radial	60	1800	0-10000		4,000.00
CollapsibleB Impeller (80X10X550mm)Radial	LQLEOHA8010550CB11	Radial	80	1500	0-10000		3,600.00

Description	Item code	Flow Type	Dia	Max RPM	Viscosity Range	Blade Type	Price/pc
SquareB Impeller(38X38X550mm) Tangential	LQLEOHA3838550SBI1	Tangential	38	1000	0-30000		4,100.00
SquareB Impeller (70X70X800mm)Tangential	LQLEOHA7070800SBI1	Tangential	70	600	0-50000		5,400.00
AnchorB Impeller (45X45X550mm)Tangential	LQLEOHA4545500ABI0	Tangential	45	800	0-100000		4,000.00
AnchorB Impeller (90X80X800mm)Tangential	LQLEOHA9080800ABI0	Tangential	90	600	0-100000		5,700.00
PaddleB Impeller (70X70X550 mm)Tangential	LQLEOHA7070550PBI0	Tangential	70	800	0-100000		5,200.00
PaddleB Impeller (70X70X800 mm)Tangential	LQLEOHA7070800PBI0	Tangential	70	600	0-100000		6,100.00
PaddleB Impeller (70X80X550 mm)Tangential	LQLEOHA7080550PBI0	Tangential	70	800	0-100000		5,200.00
PaddleB Impeller (70X80X800 mm)Tangential	LQLEOHA7080800PBI0	Tangential	70	600	0-100000		6,100.00

Stands / Clamps / Chuck

Description	Item code	Price/pc
PlateStand 220X320 mm Rod560mm 5L	LQLEOHA2232560PS01	11,300.00
PlateStand 220X320 mm Rod800mm 5L	LQLEOHA2232800PS02	12,300.00
PlateStand 220X320 mm Rod1000mm 5L	LQLEOHA2232100PS03	13,300.00
Bosshead Clamp for Plate Stand PROHS	LQLEOHA00001BHCPRO	4,400.00
Bosshead Clamp for Plate/H stand PR OHS	LQLEOHA00001BHCPRI	4,200.00
Only H Stand 500x 450x 1020mm	LQLEOHA5045102HS01	26,200.00
Bosshead Clamp for H-Stand	LQLEOHA00001BHCH01	5,300.00
OHS Key Chuck	LQLEOHA0000OHKC001	6,500.00
OHS Keyless Chuck	LQLEOHA0000OHKC002	8,000.00
OHS Chuck Cover	LQLEOHA0000OHKC004	300.00

PlateStand	Bosshead	H Stand	Key Chuck	Keyless Chuck
				

Heating Mantles

The intelligently designed safe heating mantles provide safety cut off with precise heating along with time & temperature display like never before

CE Certified Temperature Controlled Heating Mantles

The equipment precisely fits the boiling and distillation flask, round bottom flasks or relevant reaction vessels providing consistent and controllable heating of organic liquids required for the boiling, evaporation, distillation, or extraction process.

Note : The units are supplied with PT 100 probe only, Retort rod & Accessories to be procured separately.



Technical Data & Ordering Information

Model Name	GMC250	GMC500	GMC010
Flask Capacity	250 ml	500 ml	1000 ml
Working Temperature Range	Ambient +5 °C to 350 °C		
Temperature Accuracy	1°C		
Timer	upto 999 mins or continuous		
Power Requirements	1Å, 150W	1Å, 200W	1.5Å, 300W
Display	LED Display with Temperature, Time and Process Status		
Top Plate Material	MS		
Body Construction	MS		
Product Dimensions (L × B × H) mm	265 × 330 × 135		
Stage wise Heating Modes	Yes		
External Temperature Probe	PT 100		
CE Certification	YES		
HSN Code	84198990		
Ordering Code	BLFHGMC25000000000	BLFHGMC50000000000	BLFHGMC01000000000
Prices / Piece	10,000.00	10,700.00	11,400.00

Technical Data & Ordering Information

Model Name	HMC020	HMC050	HMC011
Flask Capacity	2 L	5 L	10 L
Working Temperature Range	Ambient +5 °C to 350 °C		
Temperature Accuracy	1° C		
Timer	upto 999 mins or continuous		
Power Requirements	2.5 Å, 450 W	3 Å, 600 W	6 Å, 1200 W
Display	LED Display with Temperature, Time and Process Status		
Top Plate Material	SS	SS	SS
Body Construction	MS	MS	MS
Product Dimensions (L × B × H) mm	263 × 355 × 136	339 × 430 × 170	456 × 550 × 210
Stage wise Heating Modes	Yes	Yes	Yes
External Temperature Probe	PT 100		
HSN Code	84198990		
Ordering Code	BLFHMC02000000000	BLFHMC05000000000	BLFHMC01100000000
Prices / Piece	37,680.00	43,800.00	63,230.00

Heating Mantles

Ideal for busy laboratories with multiple users or experiments needing different set temperatures at the same time

Multiposition Heating Mantles

The equipment precisely fits the boiling and distillation flask, round bottom flasks or relevant reaction vessels providing consistent and controllable heating of organic liquids required for the boiling, evaporation, distillation, or extraction process.



Technical Data & Ordering Information

Model Name	MPM062	MPM065
Heating Position	6	6
Max Flask Capacity	250 ml	500 ml
Power Consumption	1200 W	1450 W
Temperature Range	Ambient +5°C to 350°C	Ambient +5°C to 350°C
Temperature Control	PID & digital energy regulator	PID & digital energy regulator
Temperature feedback	Yes	Yes
Temperature Accuracy	1 °C	1 °C
Display Timer	0 - 999 min and Infinite	0 - 999 min and Infinite
Material of Construction	M.S Powder coated body with SS304 Top Plate	M.S Powder coated body with SS304 Top Plate
Unit Dimensions (L × B × H) mm	1000 × 330 × 135	1000 × 330 × 135
HSN Code	84198990	84198990
Ordering Code	BLFHMPM06200000000	BLFHMPM06500000000
Prices / Piece	76,560.00	76,560.00

Precision Heating Mantles

The intelligently designed safe heating mantles provide safety cutoff with precise heating & stirring features

Precise Stirring & Heating Mantles

The equipment precisely fits the boiling and distillation flask, round bottom flasks or relevant reaction vessels providing consistent and controllable heating of organic liquids required for the boiling, evaporation, distillation, or extraction process.



Technical Data & Ordering Information

Model Name	PRM250	PRM500	PRM010	PRM020
Flask Capacity	250 ml	500 ml	1L	2 L
Working Temperature Range	Ambient +5 °C to 350°C			
Temperature Accuracy	1 °C			
Timer	upto 999 mins or continuous			
Stirring Speed	300 - 2200 rpm			
Power Requirements	1Å, 150W	1Å, 200W	1Å, 300W	2.5Å, 450W
Display	LED Display with Temperature, Time and Process Status			
Top Plate Material	SS	SS	SS	SS
Body Construction	SS	SS	SS	SS
Product Dimensions (L × B × H) mm	310 × 330 × 160	310 × 330 × 160	310 × 330 × 160	263 × 355 × 136
Stage wise Heating Modes	Yes	Yes	Yes	Yes
External Temperature Probe	PT 100			
HSNCode	84198990			
Ordering Code	BLFHPRM 25000000000	BLFHPRM 50000000000	BLFHPRM 01000000000	BLFHPRM 02000000000
Prices / Piece	28,650.00	29,920.00	36,520.00	38,580.00

*PRM Capacities 5L & 10 L available on request

Vacuum Pump (Oil-free)

- Boro-017 Vacuum pump is a piston-powered, oil-free pump. With innovative electronic, mechanical technology and human design concept make, compact and light weight, clean and maintenance free, safe and comfortable.
- Driven by Piston, without the need of lubricant, regular oil changes and maintenance; with no oil pollution.
- Equipped with filter cartridge in air inlet to filter particle and moisture to prolong the life of pump.
- Motor has a built-in thermal protection device to shut off the pump automatically when overheated and then resume working when the temperature cools down.

Suitable for



BORO017
Single Position Manifold



BORO034
Three Position manifold



BORO060
Six Position manifold

Technical Data & Ordering Information

Model Name	BORO - 017	BORO034	BORO060
Power (V / Hz)	220 / 50	220 / 50	220 / 50
Max. Vacuum (Absolute & Guage)	100 mbar / -670 mm Hg		
Max. flow rate	17 L / min	34 L / min	60 L / min
Motor rotation	1450 rpm	1450 rpm	1450 rpm
Outlet Port thread	9 mm	9 mm	9 mm
Vacuum Stage	Single	Double	Double
Suitable for Filtration	Single Station Manifold	3 Position manifold	6 Position manifold
Noise level	50 dB	60 dB	52 dB
Weight	4.4 kg	5.4 kg	8.6 kg
Dimension (W × D × H) mm	(272 × 142 × 165)	310 × 152 × 165	340 × 155 × 195
Electrical Requirement	0.3 A	0.4	1
Power Consumption	65 W	80	190
Ordering Information	100VP300017	100VP400034	100VP600060
HSN Code	84798200	84798200	84798200
Prices / Piece	34,300.00	55,200.00	68,300.00

* Note Caution - Oil Free Series -Never pump toxic, explosive, flammable, corrosive gases, chemicals, solvents or powders. Flowing substances, explosion or fire can cause bodily injury. Install the pump in an area without explosive or flammable substances.

The pumps cover aqueous base filtration range.

Accessories

Description	Ordering Code
Vacuum Suction Bottle* To maintain an inert environment by removing air or gases from the reaction vessel.	100VPSB0020



*Connecting a vacuum suction bottle in case of oilfree pump filtrations helps protect the pump's components by preventing any liquid or solid material from entering the pump during the filtration process. Thus it ensures higher lifespan for Pump.

Chemical resistance vacuum Pump

The construction with PTFE makes them very resistant to chemical vapors from inlet to exhaust and very tolerant to condensates. Pumping chambers are hermetical ensuring long lifetimes of mechanical parts. Most importantly, diaphragm pumps are oil-free, with vastly reduced service demands compared with oil sealed pumps. They eliminate the cost of water and its contamination well-known from water-jet aspirators and the waste-oil disposal of rotary vane pumps. They are chemical resistant diaphragm vacuum pumps which can be widely used for hard acidic, basic and solvent vapors by utilizing corrosion proof PTFE on all the wetted surfaces.

- High chemical resistant - Solvent base filtrations
- Long-term durable
- No air pollution, maintenance free
- Smooth surfaces for easy cleaning
- Sealing system provides reduced leakage rates for improved ultimate vacuum
- Quiet and low vibration
- Thermal protection device



BORO CR C300



BORO CR C400

Technical Data & Ordering Information

Model Name	BORO CR C300	BORO CR C400	BORO CR C410	BORO CR C510
Power (V / Hz)	220V / 50Hz	220V / 50Hz	220V / 50Hz	220V / 50Hz
Max. Vacuum	101 mbar	120 mbar	13 mbar	8 mbar
Max. flow rate	22 L / min	34 L / min	25 L / min	34 L / min
Motor rotation	1450 rpm	1450 rpm	1450 rpm	1450 rpm
Outlet Port thread	10 mm	10 mm	10 mm	10 mm
Vacuum Stage	Single	Single	Double	Double
Noise level	50 dB	50 dB	50 dB	60 dB
Weight	6 kg	8.5 kg	8.5 kg	13.2 kg
Dimension (W × D × H) mm	233 × 110 × 210	294 × 156 × 195	294 × 156 × 195	380 × 156 × 226
Electrical Requirement	0.5	0.5	0.5	0.5
Power Consumption	60	95	95	245
Ordering Information	100VPC30022	100VPC40034	100VPC41025	100VPC51034
Prices / Piece	On Request	On Request	On Request	On Request

* Accessories like Vacuum controller are available on request.

Glass Dryer

Labquest dryer offers basic solutions of quick drying laboratory glasswares at 60 °C

Labquest Glass dryers can be used as bench top model or wall hanging in your laboratory washing area. It offers drying of laboratory articles in 10 to 15 minutes. Useful for quick drying viz. GCMS glasswares, Kjeldahl digestion tubes, routine work involving assorted glassware, general purpose drying.



Technical Data & Ordering Information

Model Name	GDS020
Number of Pegs	21
16 mm	8 Nos
10 mm	8 Nos
7 mm	5 Nos
Temperature Range	Ambient to 70°C
Time Control	Yes
Drying Power	650 W
Dimension (L × B × H) in mm	440 × 170 × 550
Voltage (V)	240 V
HSN Code	84798200
Ordering Code	BLFGGDS02000000000
Prices / Piece	26,290.00

Liquid Handling System & Life Science Equipment

Precision and efficiency are the foundation of every breakthrough in research and diagnostics. Our comprehensive range of Bottle Top Dispensers, Digital Burettes, Micropipettes, Centrifuges, Shakers, Incubators, and Vortex Mixers is designed to enhance accuracy and streamline laboratory workflows.

Built to meet the highest industry standards in pharmaceuticals, life sciences, and analytical research, our products focus on innovation and user-friendly design. They ensure seamless performance, enabling scientists and professionals to achieve consistent and dependable results.



BOTTLE TOP DISPENSER

DIY calibration for safe chemical handling

NABL certified for accuracy and Compliance

DIGITAL BURETTE

Fine adjustment wheel for precise endpoint detection

Data logging ensures GLP compliance

For more details

Please contact CT Enterprises for quotation.

Email: sales@ctenterprises.in | Phone: +91 8977721310



MICROPIPETTES

Wide range of manual & electronic micropipettes (0.1–10,000 μ L) for accuracy & precision

Ergonomic design minimizes thumb strain for prolonged use.

VORTEX MIXERS

For quick, efficient mixing of single or multiple samples

Stable & user-friendly design

DRY BATH

Microprocessor-controlled ensures accurate temperature regulation

Interchangeable aluminum blocks for diverse lab needs

Please contact CT Enterprises for quotation.

Email: sales@ctenterprises.in | Phone: +91 8977721310

PRACTICAL

Redefining Dispensing
A New Era of
Precision & Efficiency

BOTTLE TOP DISPENSER



**Backed by
NABL Lab
accreditation**

our Bottle Top
Dispenser (BTD)
certificates provide
complete accuracy
and precision
readings, delivering
a new standard of
transparency in the
industry.



Wipeout
piston for
**Smooth
Operation**

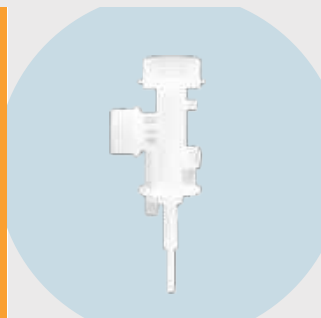

DIY
Calibration

**Safety
Mechanism**

to avoid accidental
push outs of
the discharge valve



**Springless
Valve**

To ensure a durable,
maintenance free
design



For more queries write to

Please contact CT Enterprises for quotation.

Email: sales@ctenterprises.in | Phone: +91 8977721310

ROBUST • PRACTICAL

Bottle Top Dispensers

Great Sample Preparations are made easy by Lab Essentials Dispensers

- Splash safety guard
- Hybrid valve for smooth operation
- Easy calibration reset
- QR code for chemical compatibility chart



Without recirculation

With recirculation

Technical Data & Ordering Information

Product Code RESEARCH Without Recirculation	Volume Range (ml)	Increment (ml)	Accuracy		CV		Prices / Piece ₹
			± %	± ml	± %	± ml	
BLFLLH002011002D00	0.25 - 2.5	0.05	0.6	0.012	0.2	0.004	15,230.00
BLFLLH002011005D00	0.5 - 5.0	0.1	0.6	0.03	0.2	0.01	15,230.00
BLFLLH002011016D00	1.0 - 10.0	0.2	0.6	0.06	0.2	0.02	15,230.00
BLFLLH002011020D00	2.5 - 25.0	0.5	0.6	0.18	0.2	0.06	22,030.00
BLFLLH002011040D00	5.0 - 50.0	1	0.6	0.36	0.2	0.12	22,030.00
BLFLLH002011100D00	10.0 - 100.0	2	0.6	0.6	0.2	0.2	26,290.00

Product Code PINNACLE With Recirculation	Volume Range (ml)	Increment (ml)	Accuracy		CV		Prices / Piece ₹
			+ %	+ ml	+ %	+ ml	
BLFLLH002012002D00	0.25 - 2.5	0.05	0.6	0.012	0.2	0.004	25,150.00
BLFLLH002012005D00	0.5 - 5.0	0.1	0.6	0.03	0.2	0.01	25,150.00
BLFLLH002012016D00	1.0 - 10.0	0.2	0.6	0.06	0.2	0.02	25,150.00
BLFLLH002012020D00	2.5 - 25.0	0.5	0.6	0.18	0.2	0.06	33,440.00
BLFLLH002012040D00	5.0 - 50.0	1	0.6	0.36	0.2	0.12	35,660.00
BLFLLH002012100D00	10.0 - 100.0	2	0.6	0.6	0.2	0.2	51,410.00



Unleash the
power of
pinpoint
precision with

e-Titrate



DIY
DO IT YOURSELF
Re-Calibration



Efficient and
Accurate
Volume
Adjustment



Efficient Air
purging with
0% Reagent
Loss

90°



360°
Working
Piston



100%
Drip Free

180°



DIY
DO IT YOURSELF
Re-Calibration

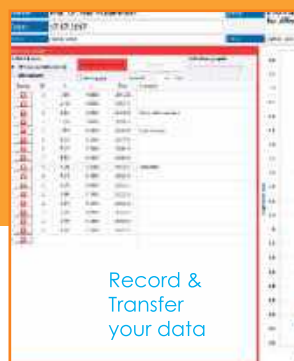

Record &
Transfer
your data

By turning the discharge tube at 180° all liquid flows back into the bottle. No more accidental discharge.

Maintain and Control accuracy by in built CAL mode.

Through the access to the e Titrate memory, all data can be transferred to a PC - No more Transmission error.

e-Titrate

An ergonomically designed digital burette: a perfect solution for Industrial Titration, Environmental and analytical testing, and pharmaceutical analysis.

- Fine adjustment wheel for determining accurate end point
- 2 in 1 instrument for Dosing and Titration
- Built in Calibration mode for liquids of different viscosities
- Moving Cannula for purging and drip free titration
- Complies with DIN ISO 8655-3 Standard
- Memory function allowing storage of 1000 readings

Note : Data could be transferred in PC through RS232 or USB cable using Titrexsoft software as optional Accessory.



Technical Data & Ordering Information

Product code	DB050
Capacity (ml)	0- 50 ml
Display Increment (ml)	0.01
Accuracy in +- %	0.06%
Accuracy in +- ml	0.03
CV in +- %	0.02%
CV in +- ml	0.01
HSN Code	90278090
Ordering Code	LH00201401200FA000
Prices / Piece	1,23,900.00

Accessories

Description	Ordering Code	Price
software along with RS232/ USB Cable	LH002014012FAACC01	On Request

e- Dispenser **COMING SOON**

Introducing the next evolution in lab equipment – our Dispenser seamlessly transition from sample preparation to testing with unparalleled precision and versatility.

- 3 calibrated preset speed
- In built calibration features allowing highest accuracy
- USB interface for data transfer



Technical Data & Ordering Information

Product code	EHD050
Capacity (ml)	0- 50 ml
Dispense Display Increment (ml)	0.2
Accuracy in +- %	0.10%
Accuracy in +- ml	0.05
CV in +- %	0.05%
CV in +- ml	0.025
HSN Code	90278090
Ordering Code	BLFLLH002014012E00
Prices / Piece	On Request

Micropipettes

C1 Designed to take manual liquid-handling workflows to a whole new level with industry-leading accuracy and precision.

- Silicone Oring for optimal tip seal
- Robust design includes metal tip base
- Low operating thumb force



Technical Data & Ordering Information - Fixed volume

Model Name	Volume Range (µl)	Inaccuracy (%)	Imprecision (%)	Prices / Piece ₹
LHC17111001	1	2.5	1.8	17,010.00
LHC17111002	2	2.5	1.8	17,010.00
LHC17111005	5	1.2	0.8	17,010.00
LHC17111006	10	1.0	0.5	17,010.00
LHC17111008	20	1.0	0.3	17,010.00
LHC17111009	25	0.8	0.4	17,010.00
LHC17111010	30	1.2	0.4	17,010.00
LHC17111012	50	1.0	0.3	17,010.00
LHC17111016	100	0.7	0.2	17,010.00
LHC17111020	200	0.6	0.2	17,010.00
LHC17111021	250	2.0	0.6	17,010.00
LHC17111024	500	0.8	0.2	17,010.00
LHC17111029	1000	0.8	0.2	17,010.00
LHC17111030	2000	1.2	0.3	17,010.00
LHC17111033	5000	0.6	0.2	17,010.00
LHC17111038	10000	0.6	0.2	17,010.00
HSN Code	90318000			

Technical Data & Ordering Information - Variable volume

Model Name	Volume Range (µl)	Volume Increment (µl)	Inaccuracy (%)	Imprecision (%)	Prices / Piece ₹
LHC17112002	0.2-2	0.02	2.0	1.00	21,160.00
LHC17112005	0.5-10	0.10	1.0	0.50	21,160.00
LHC17112008	2-20	0.20	1.0	0.30	21,160.00
LHC17112016	5-50	0.50	1.0	0.30	21,160.00
LHC17112020	10-100	1.00	0.7	0.20	21,160.00
LHC17112024	20-200	2.00	0.6	0.20	21,160.00
LHC17112029	100-1000	10.00	0.8	0.20	21,160.00
LHC17112033	1000-5000	50.00	0.6	0.15	21,160.00
LHC17112038	1000-10000	20.00	0.6	0.15	21,160.00
HSN Code	84798200				

Universal Graduated Tips for 5ml & 10ml Micropipettes

Product Code	Short Code	Tip Vol. (µl)	Selling Unit	Prices / Piece
BGT0C10005000B	BGT-C10005	5000	100 Tips/ pack	1,420.00
BGT0C10010000B	BGT-C10010	10000	100 Tips/ pack	3,200.00

Micropipettes

C1 Multichannel pipettes minimize human error and maximize the reliability of manual liquid transfer in scientific experiments.

- Ergonomically designed for stress free pipetting
- Recommended for ELISA test
 - Molecular screening
 - Kinetic studies
 - DNA Amplification



Technical Data & Ordering Information - 8 channel

Model Name	Volume Range (µl)	Volume Increment (µl)	Inaccuracy (%)	Imprecision (%)	Prices / Piece ₹
LHC17113001	0.5-10	0.1	2.00	1.00	36,680.00
LHC17113002	2-20	0.2	2.00	1.00	36,680.00
LHC17113009	5-50	0.5	1.40	0.60	36,680.00
LHC17113016	10-100	1	1.30	0.50	36,680.00
LHC17113020	20-200	2	1.20	0.40	36,680.00
LHC17113022	30-300*	2	1.40	0.30	36,680.00
HSN Code	90318000				

* 30 - 300 µl Multichannel pipetti is available with two knoba : 30 - 200 µl & 125-300 µl

Technical Data & Ordering Information - 12 channel

Model Name	Volume Range (µl)	Volume Increment (µl)	Inaccuracy (%)	Imprecision (%)	Prices / Piece ₹
LHC17114001	0.5-10	0.1	2.00	1.00	40,810.00
LHC17114002	2-20	0.2	2.00	1.00	40,810.00
LHC17114009	5-50	0.5	1.40	0.60	40,810.00
LHC17114016	10-100	1.0	1.30	0.50	40,810.00
LHC17114020	20-200	2.0	1.20	0.40	40,810.00
LHC17114022	30-300*	2.0	1.40	0.30	40,810.00
HSN Code	90318000				

* 30 - 300 µl Multichannel pipetti is available with two knoba : 30 - 200 µl & 125-300 µl

Optional Accessories

Description	Product Code	Qty/Pack	Prices / Piece ₹
C1 Fixed Vol Knob	On Request	1	2,760.00
C1 Variable Vol Knob	On Request	1	4,520.00

Micropipettes

C2 Micropipettes are ergonomically designed, lightweight, and easy to handle, reducing hand and arm strain during prolonged use.

- Metal shaft with double O-rings for ultra micro sizes
- Durable tip cone made of PVDF exhibits exceptional resistance to physical wear and chemical corrosion.
- Soft plunger light weight and volume lock
- Over sized volume Indicator ensures easy volume monitoring



Technical Data & Ordering Information - Fixed volume

Model Name	Volume Range (µl)	Inaccuracy (%)	Imprecision (%)	Prices / Piece ₹
LHC27111001	1	2.5	1.8	9,720.00
LHC27111002	2	2	1	9,720.00
LHC27111005	5	1.2	0.8	9,720.00
LHC27111006	10	1	0.5	9,720.00
LHC27111008	20	1	0.3	9,720.00
LHC27111012	50	1	0.3	9,720.00
LHC27111016	100	0.7	0.2	9,720.00
LHC27111020	200	0.6	0.2	9,720.00
LHC27111024	500	0.8	0.15	9,720.00
LHC27111029	1000	0.8	0.2	9,720.00
LHC27111033	5000	0.6	0.15	9,720.00
LHC27111038	10000	0.6	0.15	9,720.00
HSN Code	84798200			

Technical Data & Ordering Information - Variable volume

Model Name	Volume Range (µl)	Volume Increment (µl)	Inaccuracy (%)	Imprecision (%)	Prices / Piece ₹
LHC27112002	0.1-2	0.01	2	1	12,960.00
LHC27112005	0.5-10	0.02	1	0.5	12,960.00
LHC27112008	2-20	0.02	1	0.3	12,960.00
LHC27112016	5-50	0.1	1	0.3	12,960.00
LHC27112020	10-100	0.1	0.7	0.2	12,960.00
LHC27112024	20-200	0.2	0.6	0.2	12,960.00
LHC27112029	100-1000	1	0.8	0.2	12,960.00
LHC27112033	1000-5000	10	0.6	0.15	15,340.00
LHC27112038	1000-10000	20	0.6	0.15	16,950.00
HSN Code	84798200				

Universal Graduated Tips for 5ml & 10ml Micropipettes

Product Code	Short Code	Tip Vol. (µl)	Selling Unit	Prices / Piece
BGT0C10005000B	BGT-C10005	5000	100 Tips/ pack	1,420.00
BGT0C10010000B	BGT-C10010	10000	100 Tips/ pack	3,200.00

Micropipettes

C2 Multichannel Micropipettes are optimized for high-throughput applications, offering a lightweight ergonomic design that enhances efficiency and reduces user fatigue in repetitive tasks

- Precision-engineered metal shaft with double O-rings for consistent performance in multi-well plate work.
- Durable PVDF tip cone resists chemical corrosion, ideal for handling diverse reagents.
- Smooth, lightweight plunger with a volume lock mechanism for accurate and reliable dispensing.

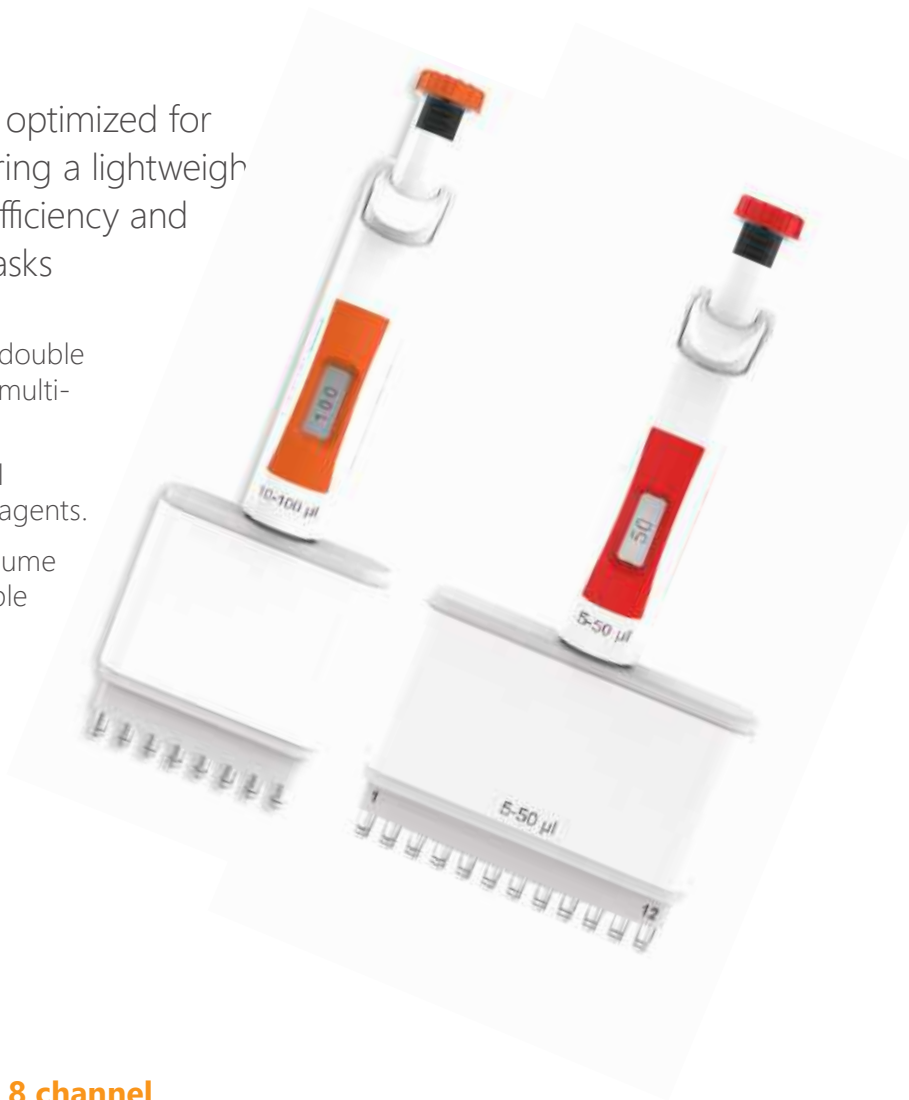

Technical Data & Ordering Information - 8 channel

Model Name	Volume Range (µl)	Volume Increment (µl)	Inaccuracy (%)	Imprecision (%)	Prices / Piece ₹
LHC27113001	0.5-10	0.1	2	1	36,680.00
LHC27113016	10-100	1	1.3	0.5	36,680.00
LHC27113022	30-300*	2	1.4	0.3	36,680.00
HSN Code	90318000				

* 30 - 300 µl Multichannel pipetti is available with two knoba : 30 - 200 µl & 125-300 µl

Technical Data & Ordering Information - 12 channel

Model Name	Volume Range (µl)	Volume Increment (µl)	Inaccuracy (%)	Imprecision (%)	Prices / Piece ₹
LHC27114001	0.5-10	0.1	2	1	40,810.00
LHC27114016	10-100	1	1.3	0.5	40,810.00
LHC27114022	30-300*	2	1.4	0.3	40,810.00
HSN Code	90318000				

* 30 - 300 µl Multichannel pipetti is available with two knoba : 30 - 200 µl & 125-300 µl

Micropipettes

C3 Lightweight, Ergonomic pipette design for every lab application

- Crafted for a comfortable 4 lightweight user experience
- Compatible with universal tips
- ideal shaft for reaching into narrow/deep tubes.



Technical Data & Ordering Information - Fixed volume

Model Name	Volume Range (µl)	Inaccuracy (%)	Imprecision (%)	Prices / Piece ₹
LHC37111001	1	2.5	1.8	4,450.00
LHC37111002	2	2.5	1.2	4,450.00
LHC37111005	5	1.2	0.8	4,450.00
LHC37111006	10	1.0	0.5	4,450.00
LHC37111008	20	1.0	0.3	4,450.00
LHC37111009	25	0.8	0.4	4,450.00
LHC37111010	30	1.2	0.4	4,450.00
LHC37111012	50	1.0	0.3	4,450.00
LHC37111016	100	0.7	0.2	4,450.00
LHC37111020	200	0.6	0.2	4,450.00
LHC37111021	250	0.4	0.2	4,450.00
LHC37111024	500	0.8	0.2	4,450.00
LHC37111029	1000	0.8	0.2	4,450.00
LHC37111033	5000	0.6	0.2	4,450.00
LHC37111038	10000	0.6	0.2	4,450.00
HSN Code	90318000			

Technical Data & Ordering Information - Variable volume

Model Name	Volume Range (µl)	Volume Increment (µl)	Inaccuracy (%)	Imprecision (%)	Prices / Piece ₹
LHC37112002	0.2-2	0.01	2.00	1.0	6,240.00
LHC37112005	0.5-10	0.10	1.00	0.5	6,240.00
LHC37112008	2-20	0.10	1.00	0.3	6,240.00
LHC37112016	5-50	0.50	1.00	0.3	6,240.00
LHC37112020	10-100	0.50	0.70	0.2	6,240.00
LHC37112024	20-200	1.00	0.60	0.2	6,240.00
LHC37112029	100-1000	5.00	0.80	0.2	6,240.00
LHC37112033	500-5000	50.00	0.60	0.2	6,240.00
LHC37112038	1000-10000	100.00	0.60	0.15	6,240.00
HSN Code	90318000				

Universal Graduated Tips for 5ml & 10ml Micropipettes

Product Code	Short Code	Tip Vol. (µl)	Selling Unit	Prices / Piece
BGT0C30005000B	BGT-C30005	5000	100 Tips/ pack	1,420.00
BGT0C30010000B	BGT-C30010	10000	100 Tips/ pack	3,200.00

Micropipettes

C3 Lightweight, Ergonomic pipette design for every lab application

- Engineered to reach into narrow/deep tubes
- Comfortable finger rest for both right & left hand usage.



Technical Data & Ordering Information - 8 channel

Model Name	Volume Range (µl)	Volume Increment (µl)	Inaccuracy (%)	Imprecision (%)	Prices / Piece ₹
LHC37113001	0.5-10	0.10	1.5.	1.50	22,830.00
LHC37113009	5-50	0.50	1.00	0.70	22,830.00
LHC37113016	10-100	0.50	1.00	0.50	22,830.00
LHC37113020	20-200	1.0	0.70	0.25	22,830.00
LHC37113022	30-300	1.0	0.80	0.25	22,830.00
HSN Code	90318000				

Technical Data & Ordering Information - 12 channel

Model Name	Volume Range (µl)	Volume Increment (µl)	Inaccuracy (%)	Imprecision (%)	Prices / Piece ₹
LHC37114001	0.5-10	0.1	1.50	1.50	28,530.00
LHC37114009	5-50	0.5	1.00	0.70	28,530.00
LHC37114016	10-100	0.5	1.00	0.50	28,530.00
LHC37114020	20-200	1.0	0.70	0.25	28,530.00
LHC37114022	30-300	1.0	0.80	0.25	28,530.00
HSN Code	90318000				

Technical Data & Ordering Information

Model Name	Description	Prices / Piece ₹
LHC07009004	Micropipette stand for 4 Single Channel Pipette	3,810.00



Electronic Micropipettes

Electronic pipettes are ergonomic with features of pipetting, dispensing programs & reduce muscle strain by performing pipetting steps for the user

- Exceptionally lightweight for effortless pipetting.
- Different modes available - Multi dispensing, Diluting diluting + mixing sequential dispensing.
- Intelligent sleep mode for battery conservation.



Technical Data & Ordering Information -

Model Name	Volume Range (µl)	Volume Increment (µl)	Inaccuracy (%)	Imprecision (%)	Prices / Piece ₹
LHC17022042	0.5-10	0.01	1	1	41,170.00
LHC17022012	5-100	0.1	0.8	0.2	41,170.00
LHC17022008	10-200	0.1	0.6	0.2	41,170.00
LHC17022024	50 - 1000	1	0.6	0.2	41,170.00
LHC17022016	250 - 5000	5	0.6	0.2	41,170.00
HSN Code	90318000				

Technical Data & Ordering Information - 8 channel

Model Name	Volume Range (µl)	Volume Increment (µl)	Prices / Piece ₹
LHC17023001	0.5-10	0.010	68,180.00
LHC17023002	2-20	0.01	68,180.00
LHC17023016	5-100	0.10	68,180.00
LHC17023020	10-200	0.10	68,180.00
LHC17023022	15-300	0.10	68,180.00
HSN Code	90318000		

Technical Data & Ordering Information - 12 channel

Model Name	Volume Range (µl)	Volume Increment (µl)	Prices / Piece ₹
LLHC17024001	0.5-10	0.01	77,010.00
LHC17024002	2-20	0.01	77,010.00
LHC17024016	5-100	0.10	77,010.00
LHC17024020	10-200	0.10	77,010.00
LHC17024022	15-300	0.10	77,010.00
HSN Code	90318000		



Electronic Pipette Controller

FAST PIPETTE Pipette Controller:
Pipette filling device

- Can hold plastic or glass pipette from 0.1ml upto 100ml
- Double safety valve & hydrophobic filters offer double protection against fluid penetration.



Technical Data & Ordering Information

Product Code	Description
LHC17005011	Pipette filling device
HSN Code	0318000
Prices / Piece	21,730.00

Serological Pipette

Labquest Serological Pipette delivers high precision with $\pm 2\%$ accuracy and ensures sample purity with a PET filter plug. Individually wrapped for traceability, it is ideal for various laboratory applications.

- Available in 1ml, 2ml, 5ml, and 10ml volumes
- PET filter plug prevents contamination
- Bidirectional graduations for accurate readings



Product Code	Description	Packing Type	Quantity / Pack	Pack / Case	Quantity / Case	Prices / Case ₹
LHC17BSP001	1 ml Serological Pipette	Individually Wrapped	100 pcs	6	600	11000.00
LHC17BSP002	2 ml Serological Pipette	Individually Wrapped	100 pcs	6	600	12150.00
LHC17BSP005	5 ml Serological Pipette	Individually Wrapped	100 pcs	6	600	18900.00
LHC17BSP010	10 ml Serological Pipette	Individually Wrapped	100 pcs	6	600	20000.00

Premium Micro Pipette Tips

Free of PCR inhibitors, lubricants and heavy metals

With graduations for visual control of liquid transfer

Certified DNase, RNase and Pyrogen Free

Produced from special diamond polish mould using medical grade virgin polypropylene which provides very high transparency

Available in both standard as well as low retention

With no secondary treatment and with no silicone additives for low retention

With special PE filters for prevention of aerosols and contamination

Specifically configured to fit major Pipette Brands available worldwide

FILTER TIPS

BOROSIL filter tips are manufactured using specifically developed Polyethylene filters to block aerosols from entering into the pipette.

This helps in prevention of cross contamination.

Ideal for use in applications like sequencing, DNA amplification, Tissue culture, RT-PCR and other critical protocols.

LOW RETENTION TIPS

BOROSIL low retention tips are manufactured from a specific resin in combination with high quality diamond finish moulds to give super hydrophobic internal surface. This results in tips having minimum retention with maximum accuracy.

Further since no silicone treatment is given, there is absolutely no leaching effect.



Tips and Filter Tips

							
10 XL-FILTER-TIP	10 XL-Tip	10 XN-tips	10 XN-with-Filter-Tips	10µL LONG			
							
10µL XL Extra Narrow	10µL	20-200 with filter	100 µL-Tip	100µL			
							
200 µL-FILTER-TIP	100 µL-Tip	100 µL	200 µL-FILTER-TIP	200 µL-Tip			
							
200 XL-Tips	200 XL-with-Filter-Tips	200 µL	300µL	1000 µL-FILTER-TIP			
							
1000 µL-Tip	1000µL	1000XL-LONG-TIP	1000XL-LONG-TIP-WITH-FILTER	1250µL			
							
AT-5000A	AT-5000A	AT-5000B	AT-5000B	AT-10000A	AT-10000A	AT-10000B	AT-10000B

Tips

Technical Data & Ordering Information

Universal Graduated Tips Bulk Pack

Product Code	Short Code	Tip Vol. (µl)	Special Feature	Selling Unit	Prices / Piece
BGT0000010B	BGT-10B	10	-	1000 Tips / pack	630.00
BGT0000200B	BGT-200B	200	-	1000 Tips/ pack	590.00
BGT0001000B	BGT-1000B	1000	-	1000 Tips/ pack	890.00
BGT0C10005000B	BGT-C10005	5000	Only C1	100 Tips/ pack	1,420.00
BGT0C30005000B	BGT-C30005	5000	Only C3	100 Tips/ pack	1,420.00
BGT0C10010000B	BGT-C10010	10000	Only C1	100 Tips/ pack	3,200.00
BGT0C30010000B	BGT-C30010	10000	Only C3	100 Tips/ pack	3,200.00

Universal Graduated Tips Racks

Product Code	Short Code	Tip Vol. (µl)	Special Feature	Selling Unit	Prices / Piece
BGT0000010R	BGT-10	10	-	10 × 96 Tips/rack	2,630.00
BGT0000200R	BGT-200R	200	-	10 × 96 Tips/rack	2,500.00
BGT0001000R	BGT-1000R	1000	-	6 × 96 Tips/ rack	1,620.00

Universal Graduated Tips Racks Sterile

Product Code	Short Code	Tip Vol. (µl)	Special Feature	Selling Unit	Prices / Piece
BGT000010SR	BGT-10SR	10	-	10 × 96 Tips/rack	2,840.00
BGT000200SR	BGT-200SR	200	-	10 × 96 Tips/rack	2,700.00
BGT001000SR	BGT-1000SR	1000	-	6 × 96 Tips/ rack	1,870.00

Universal Graduated Tip Racks Sterile Low Retention

Product Code	Short Code	Tip Vol. (µl)	Special Feature	Selling Unit	Prices / Piece
BGT00010SLR	BGT-10SLR	10	-	10 × 96 Tips/rack	3,030.00
BGT00200SLR	BGT-200SLR	200	-	10 × 96 Tips/rack	2,970.00
BGT01000SLR	BGT-1000SLR	1000	-	6 × 96 Tips/ rack	2,420.00

Universal Graduated Tip Reload Stack Sterile

Product Code	Short Code	Tip Vol. (µl)	Special Feature	Selling Unit	Prices / Piece
BGT000010SZ	BGT-10SZ	10	-	10 × 96 Tips / rack	1,950.00
BGT000200SZ	BGT-200SZ	200	-	10 × 96 Tips / rack	1,860.00
BGT001000SZ	BGT-1000SZ	1000	-	5 × 96 Tips/ rack	1,400.00

Universal Graduated Tip Reload Stack Sterile Low Retention

Product Code	Short Code	Tip Vol. (µl)	Special Feature	Selling Unit	Prices / Piece
BGT00010SLZ	BGT-10SLZ	10	-	10 × 96 Tips / rack	2,280.00
BGT00200SLZ	BGT-200SLZ	200	-	10 × 96 Tips / rack	2,230.00
BGT01000SLZ	BGT-1000SLZ	1000	-	5 × 96 Tips/ rack	1,740.00

Filter Tips

Technical Data & Ordering Information

Universal Graduated Filter Tips Bulk Pack

Product Code	Short Code	Tip Vol. (µl)	Special Feature	Selling Unit	Prices / Piece
BGT000010FB	BGT-10FB	10	-	1000 Tips/ pack	2,900.00
BGT000020FB	BGT-20FB	20	-	1000 Tips/ pack	2,900.00
BGT000050FB	BGT-50FB	50	-	1000 Tips/ pack	2,900.00
BGT000100FB	BGT-100FB	100	-	1000 Tips/ pack	2,900.00
BGT000200FB	BGT-200FB	200	-	1000 Tips/ pack	2,900.00
BGT001000FB	BGT-1000FB	1000	-	1000 Tips/ pack	3,600.00

Universal Graduated Tips Racks

Product Code	Short Code	Tip Vol. (µl)	Special Feature	Selling Unit	Prices / Piece
BGT000010FR	BGT-10FR	10	-	10 × 96 Tips/rack	4,130.00
BGT000020FR	BGT-20FR	20	-	10 × 96 Tips/rack	4,130.00
BGT000050FR	BGT-50FR	50	-	10 × 96 Tips/rack	4,130.00
BGT000100FR	BGT-100FR	100	-	10 × 96 Tips/rack	4,130.00
BGT000200FR	BGT-200FR	200	-	10 × 96 Tips/rack	4,130.00
BGT001000FR	BGT-1000FR	1000	-	6 × 96 Tips/ rack	2,900.00

Universal Graduated Filter Tip Rack Sterile

Product Code	Short Code	Tip Vol. (µl)	Special Feature	Selling Unit	Prices / Piece
BGT00010SFR	BGT-10SFR10	10	-	10 × 96 Tips/rack	4,280.00
BGT00020SFR	BGT-20SFR	20	-	10 × 96 Tips/rack	4,280.00
BGT00050SFR	BGT-50SFR	50	-	10 × 96 Tips/rack	4,280.00
BGT00100SFR	BGT-100SFR	100	-	10 × 96 Tips/rack	4,280.00
BGT00200SFR	BGT-200SFR	200	-	10 × 96 Tips/rack	4,280.00
BGT01000SFR	BGT-1000SFR	1000	-	6 × 96 Tips/ rack	3,190.00

Universal Graduated Filter Tip Rack Sterile Low Retention

Product Code	Short Code	Tip Vol. (µl)	Special Feature	Selling Unit	Prices / Piece
BGT0010SLFR	BGT-10SLFR	10	-	10 × 96 Tips/rack	5,230.00
BGT0020SLFR	BGT-20SLFR	20	-	10 × 96 Tips/rack	5,230.00
BGT0050SLFR	BGT-50SLFR	50	-	10 × 96 Tips/rack	5,230.00
BGT0100SLFR	BGT-100SLFR	100	-	10 × 96 Tips/rack	5,230.00
BGT0200SLFR	BGT-200SLFR	200	-	10 × 96 Tips/rack	5,230.00
BGT1000SLFR	BGT-1000SLFR	1000	-	6 × 96 Tips/ rack	3,930.00

Empty Tip Box

Product Code	Short Code	Tip Vol. (µl)	Special Feature	Selling Unit	Prices / Piece
BGT00010ETR	BGT-10ETR	10	-	10 Rack Boxes	2,060.00
BGT00200ETR	BGT-200ETR	200	-	10 Rack Boxes	2,060.00
BGT01000ETR	BGT-1000ETR	1000	-	6 Rack Boxes	1,380.00

UV Sterilization Box

Experience rapid, residue-free disinfection with our multi-purpose UV sterilization box. Utilizing UV-C technology, it swiftly and effectively sanitizes without harmful chemicals or residues, ensuring an environmentally friendly and hassle-free solution for your sterilization needs.



Technical Specification

Model No.	DIC020
Inbuilt timer	User selectable from 5 to 30 minutes
Incremental time	5 mins
UV C lamp make	CE Certified GERMICIDAL UVC lamp
UV C lamp life	11000 hrs
UV C lamp wattage	11 W × 4
Outer dimension (LXDXH)	430 × 380 × 235 mm
Inner dimension (LXDXH)	420 × 255 × 170 mm
Maintenance	UVC lamps user replaceable
Unit Power	45 W
Input power	230V 50Hz Ac
Ordering Information	BLFGDIC0100000000

Micro Centrifuge

Smart, Sturdy & Silent intelligently designed micro centrifuge built to make your life easier in lab

MCF08VT

With insights gleaned from extensive user-research, Borosil's MCF08VT is everything that a user could want. From reliable performance and high-quality components to intelligently designed chassis and user-friendly interface, MCF08VT is built to make your life easier in the lab.



Technical Data & Ordering Information

Model Name	MCF08VT
Rotor position	8 × 1.5/2.0 ml Microtubes
Tube capacity in ml	1.5 / 2.0 / 0.2 / 0.5
Max speed (rpm)	1000 - 6000 rpm in 100rpm steps
RCF (g)	2000 g
Display	Digital
Noise level	< 55 db
Imbalance detection	Yes
Timer	1 - 25 Minutes & infinite mode
Dimension (L × W × H) mm	162 × 157 × 116
Weight	1.1 Kg (with rotor)
Rotors and Adaptors (included in standard pack)	8 × 1.5/2.0 ml Closed Rotor, PCR strip Rotator (2 × 8 × 0.2 m) Reduction adaptors for 0.2 / 0.5 ml Microtubes
HSN Code	8421999
Ordering Code	100MCF00800VT0
Prices / Piece	15,310.00

8 x 1.5/2ml rotor



PCR strip rotor



0.2/0.5ml tube reducers



Micro Centrifuge

Smart, Sturdy & Silent intelligently designed micro centrifuge built to make your life easier in lab

MCF12VT

Delivering top-notch accuracy in every cycle despite high load, MCF12VT has been designed keeping in mind the requirements of the clients. The lightning fast 15000 RPM microprocessor controlled centrifuge can perform at peak efficiency and give the desired results. It gives smooth and silent operation even at the maximum speed.









Technical Data & Ordering Information

Model Name	MCF12VT
Rotor position	12 × 1.5ml / 2.0ml Microtubes
Tube capacity in ml	1.5 / 2.0 / 0.5 / 0.4 / 0.2
Max speed (rpm)	15000 rpm
RCF (g)	15596 g
Display	Large digital display
Motor Type	Brushless DC motor
Noise level	< 60 db
Imbalance detection	Yes
Timer	Countdown timer : 1 - 99 Mins & infinite mode
Dimension (L × W × H) mm	187 × 265 × 115
Weight	2.2 Kgs (with rotor)
Rotors and Adaptors (included in standard pack)	12 × 1.5/2 ml Angel Rotor, Reduction adaptor for 0.2 ml Microtubes Reduction adaptor for 0.4 ml / 0.5 ml Microtubes
HSN Code	84211999
Ordering Code	100MCF01200VT0
Prices / Piece	58,170.00

Optional Accessories

Description	Ordering Code	Prices / Piece
12 × 1.5/2 ml Angle Rotor	10000MC1202MLF	10,760.00
PCR Strip Rotor (2 × 8 × 0.2 ml)	10000MC0208MLS	17,580.00

12 tubes rotor angle	1.5/2.0ml tubes		0.5ml Adaptor		0.1/0.2ml Adaptor
					
	1.5/2 ml	0.5 ml	0.4 ml	0.2 ml	0.1 ml
Max. Speed	15000	15000	15000	15000	15000
Max. RCF	15596	12577	12074	11105	10278

PCR strip rotor (Optional)	0.1/0.2ml PCR strip
	
Max. Speed	15000
Max. RCF	13080

Micro Centrifuge

A resilient micro centrifuge meticulously designed to ensure seamless centrifugation with each rotation.

MCF24VT

The MCF24VT, a 24-place rotor centrifuge, attains speeds up to 17040g, featuring a thoughtfully designed low loading height. Crafted after extensive customer research, it is ideal for clinical, molecular, and bacteriological applications.



Technical Data & Ordering Information

Product code	MCF24VT
Rotar Position	24 × 1.5/2 ml microtube
Tube capacity in ml	0.1/0.2/1.5/2.0
Max speed (rpm)	500-13400 RPM in steps of 100 RPM
RCF	17040 g
Display	Large digital display
Motor Type	Brushless DC motor
Lid Lock Safety	Yes
Noise level	<60 dB
Imbalance detection	Yes
Timer	1 to 999 mins & infinite mode
Dimension (L × W × H) mm	381 × 480 × 185
Weight	8.2 kg (without rotor)
Rotors and Adapters (Included in standard pack)	24 × 1.5/ 2 ml microtube rotor Reduction adapter for 0.1/0.2/0.5 ml microtubes.
HSN Code	84211999
Ordering Code	100MCF00240VT0
Prices / Piece	86,820.00

24 x 1.5/2ml



0.2/0.5ml tube reducers



Cooling High Speed Micro Centrifuge

Unmatched performance, safety with preset features for quick cooling



Technical Data & Ordering Information

Model Name	CLMC24VT
Cooling temperature	Up to -20°C
Max speed (rpm)	500 - 15000 rpm
Programmable Feature	User can set and save up to 99 user defined programs of 4 lines each
Display	Large back lit LCD display
Motor Type	Brushless DC motor
Lid Lock Safety	Yes
Imbalance detection	Yes
Timer Setting	30 secs to 999 mins & infinite mode
Dimension (L x W x H) in mm	452 x 314 x 278
Weight	Approx. 43 kgs
HSN Code	84211999
Ordering Code*	100CLMC2400VT0
Prices / Piece	On Request

* Product is supplied without rotors, add rotors as per your application

Optional Accessories

Description	Ordering Code	Prices / Piece
Microtubes Rotor (24 x 1.5 / 2 ml) (21420 x g)	100CLMC2402MLF	28,050.00
Microtubes Rotor (44 x 1.5 / 2 ml) (22388 x g)	100CLMC4402MLF	37,970.00
Angal Rotor 8 x 5 ml (18461 x g)	100CLMC0805MLF	41,550.00
PCR Strip Rotor (4 x 8 x 0.2 ml) (15397 x g)	100CLMC4802MLS	42,110.00

24 x 2ml rotor (standard supply)	1.5/2.0ml tubes	0.5ml Adaptor	0.1/0.2ml Adaptor		PCR strip rotor (optional)	0.2ml PCR strip	44 x 2ml rotor (optional)	1.5/0.2ml tubes	0.5ml Adaptor	0.1/0.2ml Adaptor		8 x 5ml rotor (optional)	5ml tube
Max. Speed	15000	15000	15000	15000	Max. Speed	15000	Max. Speed	15000	15000	15000	15000	Max. Speed	15000
Max. RCF x g	21420	18842	16103	16930	Max. RCF x g	15397	Max. RCF x g	22388	19810	17070	17898	Max. RCF x g	18461

Clinical Centrifuge

Centrifuge for clinical application are designed to accommodate rotor and blood centrifuge tubes

Accommodates widely used tubes
 - Supplied with adaptors for 2ml, 5ml, 6ml, 9ml (blood collection tube)



Technical Data & Ordering Information

Model Name	DCF06VT
Rotor position	6 × 15 ml (Fixed angle)
Tube capacity in ml	2 / 5 / 7 / 15 ml
Max speed (rpm)	6500 rpm + 100 rpm
RCF (g)	3684 g - 6 × 15 ml
Motor Type	Brushless DC motor
Noise level (db)	< 60 db
Lid Lock Safety	Yes
Imbalance detection	Yes
Timer setting	1 - 30 Minutes & infinite mode
Dimension (L × W × H) mm	260 × 244 × 205
Weight	4 Kgs (with rotor)
Rotors and Adaptors (included in standard pack)	6 × 15ml rotor (Fixed angle) Adaptor for 2ml/5ml/6ml Blood collection tube
HSN Code	84211999
Ordering Code*	100DCF00600VT0
Prices / Piece	54,930.00

* Also available in 8 × 15 ml fixed angle rotor (3873g) Part No. 100DCF00800VT0

Optional Accessories

Description	Ordering Code	Prices / Piece
Fixed angle rotor, 8 × 15 ml (3873g)	100CCFA0815MLF	18,170.00

Clinical Centrifuge

Expertly designed Clinical centrifuge for PRP protocols, accommodating wide range of sample sizes while ensuring user protection with motorized safety Latch



Technical Data & Ordering Information

Product code	CCD4000VT
Rotar Position*	6 × 10 ml (swing out rotor), 8 × 15 ml (Fixed angle), 16 × 10 ml (fixed angle)
Tube capacity in ml	10/15 ml
Max speed (rpm)	500 - 4000 RPM in steps of 10 RPM
RCF	2270 g - 6 × 10 ml
Motor Type	BLDC
Lid Lock Safety	Yes
Noise level	≤65 dB
Imbalance detection	Yes
Timer	1 to 999 mins, infinite
Dimension (L × W × H) mm	381 × 480 × 185
Weight	8.2 kg (without rotor)
HSN Code	8421999
Ordering Code	100CCD00400VT0
Price / Piece	64,950.00

*Product is supplied without rotors. Rotors to be added as per application

Accessories

Description	Ordering Code	Max Speed	Max RCF × g	Price
Swing out rotor 6 × 10 ml	100CCD0610MLS	4000	2270 g	6,530.00
Fixed angle rotor 8 × 15 ml	100CCD0815MLF	4000	1950 g	6,530.00
Fixed angle rotor 16 × 10 ml	100CCD1610MLF	4000	2180 g	9,530.00

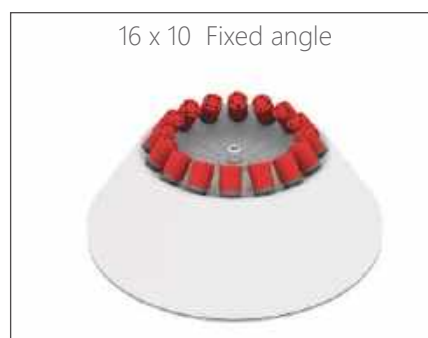

Clinical Centrifuge

Optimize your molecular biology work flows with a fixed angle plate clinical centrifuge. Tailored for real-time and end time PCR applications for both skirted and nonskirted PCR plates.



Technical Data & Ordering Information

Product code	CCFA250VT
Rotar capacity*	2 microplate - 96 & 384 wells (Fixed Angle)
Maximum RPM/RCF(g)	2500 RPM / 462 g
Motor Type	Brushless DC motor
Speed setting	500 - 2500 RPM in steps of 100 RPM
Timer setting	1 - 99 mins & infinite mode
Lid Lock Safety	Yes
Noise Level	<65 dB
Programmable feature	User can set & save P1 & P2 user defined programs (protocol)
Dimensions (L × W × H)	330 × 265 × 161 mm
Voltage / Consumption	24 W
Weight	4.0 kgs
HSN Code	8421999
Ordering Code	100CCFA0250VT0
Price / Piece	29,260.00

*Rotor supplied as standard accessory



Clinical Centrifuge

Clinical Centrifuge crafted for hematocrit application. The innovative HCT rotor combined with a screw on top lid, not only enhances operational ease but also provides superior protection against contamination.



Technical Data & Ordering Information

Product code	CCH120VT
Rotar capacity*	24 × up to 75 mm length capillary tubes
Maximum RPM/RCF(g)	12000 RPM / 14118 g
Motor Type	Brushless DC motor
Speed setting	500-12000 RPM in steps of 100 RPM
Timer setting	Upto 12 mins
Lid Lock Safety	Yes
Rotor	HCT Rotor with screw on lid
Programmable feature	User can set parameters beforehand
Dimensions (L × W × H)	330 × 265 × 161 mm
Voltage / Consumption	24 V 5.6 A / 132 W
Weight	4.5 Kgs
HSN Code	84211999
Ordering Code	100CCH12000VT0
Price / Piece	69,750.00

*Rotor & Reader supplied as standard accessory



Clinical Centrifuge

Centrifuge for clinical application are designed to accommodate rotor and blood centrifuge tubes



Technical Data & Ordering Information

Model Name	CCD4504VT
Rotor position	Combi Rotor 4 × 50 ml + 4 × 15 ml or 8 × 15 ml
Tube capacity in ml	15 / 50 ml
Max speed (rpm)	4500 rpm
RCF (g)	1985 × g
Motor Type	Brushless DC motor
Noise level (db)	< 60 db
Lid Lock Safety	Yes
Imbalance detection	Yes
Timer setting	1 - 99 Minutes & infinite mode
Dimension (L × W × H) mm	330 × 265 × 161
Weight	4 Kgs
Rotors and Adaptors (included in standard pack)	Combi Rotor 4 × 50 ml + 4 × 15 ml or 8 × 15 ml Adaptor for 5ml, 7ml, 10ml standard blood collection tube
HSN Code	8421999
Ordering Code	100CCD04504VT0
Prices / Piece	35,120.00

Additional Technical Data

Tube Capacity	50ml	15ml	10ml	7ml	5ml
Dimensions (mm)	025 × 115	017 × 120	016 × 100	013 × 100	012 × 75
Radius (mm)	8.77	8.77	8.77	8.37	8.37
Speed (RPM)	4500	4500	4500	4500	4500
Max. RCF	1985	1985	1985	1985	1985
Total no. of tube	4	8	8	8	8
Adaptor Required	No	No	Yes	Yes	Yes
	No	No	No	No	Yes
	No	No	No	Yes	No

Universal Lab Centrifuge

Designed to provide ideal results with combination rotor with unparalleled safety features



Technical Data & Ordering Information

Model Name	ULC4504VT
Rotor position (max)	4 × 100 ml
Max speed (rpm)	4500 rpm
RCF (g)	g varies as per rotor
Motor Type	Brushless DC motor
Display	Digital
Lid Lock Safety	Yes
Imbalance detection	Yes
Timer Setting	30 sec - 99 mins & infinite mode
Speed Setting	500 to 4500 rpm
Dimension (L × W × H) mm	475 × 585 × 325
Weight	23 Kgs (without rotor)
Rotors (not included)	Multiple rotor options (swing and fixed angle)
HSN Code	84211999
Ordering Code*	100ULC04504VT0
Prices / Piece	81,000.00

Product is supplied without rotors, add rotors as per your application

Optional Accessories

Description	Ordering Code	Max Speed	Max RCF × g	Prices / Piece ₹
Swing Out Rotor 32 × 6ml	100UC1A3206MLS	4500	3164 g	26,400.00
Swing Out Rotor 16 × 15ml	100UC1A1615MLS	4500	3485 g	14,270.00
Swing Out Rotor 4 × 50ml	100UC1A0450MLS	4500	3485 g	19,790.00
Swing Out Rotor 4 × 100ml (with lid)	100UC1A0401LMS	4500	3164 g	35,200.00
Swing Out Rotor 2 Micro plates	100UC1A0002MPS	4500	2355 g	39,690.00
Fixed Angle Rotor 16 × 15ml	100UC1A1615MLF	4500	3144 g	12,740.00
Fixed Angle Rotor 6 × 50ml	100UC1A0650MLF	4500	2644 g	9,120.00
Fixed Angle Rotor 4 × 50ml	100UC1A0450MLF	4500	2644 g	8,510.00
Fixed Angle Rotor 4 × 100ml	100UC1A0401MLF	4500	2599 g	17,810.00
Fixed Angle Rotor 24 × 15ml	100UC1A2415MLF	4500	2854 g	21,370.00

Universal Lab Centrifuge

Designed to provide ideal results with combination rotor with unparalleled safety features



Technical Data & Ordering Information

Model Name	ULC4204VT
Rotor position (max)	4 × 250 ml
Max speed (rpm)	4200 rpm
RCF (g)	g varies as per rotor
Motor Type	Brushless DC motor
Display	Digital
Lid Lock Safety	Yes
Imbalance detection	Yes
Timer Setting	30 sec - 99 mins & infinite mode
Speed Setting	500 to 4500 rpm
Dimension (L × W × H) mm	475 × 585 × 325
Weight	23 Kgs (without rotor)
Rotors (not included)	Multiple rotor options (swing and fixed angle)
HSN Code	8421999
Ordering Code*	100ULC04204VT0
Prices / Piece	1,13,520.00

Product is supplied without rotors, add rotors as per your application

Optional Accessories

Description	Ordering Code	Max Speed	Max RCF × g	Prices / Piece ₹
Swing Out Rotor 32 × 6ml	100UC2A3206MLS	4200	2766 g	26,210.00
Swing Out Rotor 16 × 15ml	100UC2A1615MLS	4200	2884 g	24,260.00
Swing Out Rotor 4 × 50ml	100UC2A0450MLS	4200	2884 g	19,790.00
Swing Out Rotor 4 × 100 ml	100UC2A0401MLS	4200	2766 g	18,170.00
Swing Out Rotor 4 × 250 ml	100UC2A0402MLS	4200	3181 g	56,810.00
Swing Out Rotor 64 × 6 ml	100UC2A6406MLS	4200	3181 g	54,470.00
Swing Out Rotor 2 Micro plates	100UC2A0002MPS	4200	2074 g	39,690.00
Fixed Angle Rotor 16 × 15ml	100UC2A1615MLF	4200	2410 g	12,740.00
Fixed Angle Rotor 6 × 50ml	100UC2A0650MLF	4200	2410 g	8,510.00
Fixed Angle Rotor 4 × 50ml	100UC2A0450MLF	4200	2331 g	8,510.00
Fixed Angle Rotor 4 × 100ml	100UC2A0401MLF	4200	2272 g	17,810.00
Fixed Angle Rotor 24 × 15ml	100UC2A2415MLF	4200	2489 g	21,370.00

High Speed Universal Lab Centrifuge

Centrifuge boasts a stainless steel rotor for rapid pelleting and centrifugation with a convenient short spin option. Its intelligent air flow system guarantees precise temperature regulation in the chamber, combining durability and ease of maintenance.



Technical Data & Ordering Information

Model Name	ULC1504VT
Rotar Position (max)	4x100 ml
Max speed (rpm)	500-15000 RPM in steps of 100 RPM
RCF	22388 g
Display	Large digital display
Motor Type	Brushless DC motor
Lid Lock Safety	Yes
Noise level	<65dB
Imbalance detection	Yes
Timer	1 to 999 mins 59 secs. & infinite mode
Dimension (L X W X H) mm	475 × 585 × 325
Weight	23 kg (without rotor)
HSN Code	84211999
Ordering Code	100ULC1504VT00
Prices / Piece	1,40,880.00

* Product is supplied without rotors. Rotors to be added as per application

Optional Accessories

Description	Ordering Code	Max Speed	Max RCF × g	Prices / Piece ₹
Swing Out Rotor 16 × 15 ml	100UC3A1615MLS	4500	3305 g	21,930.00
Swing Out Rotor 4 × 50 ml	100UC3A0450MLS	4500	3305 g	18,420.00
Swing Out Rotor 4 × 100 ml	100UC3A0401MLS	4500	3305 g	17,830.00
Swing Out Rotor 2 Micro plates	100UC3A0002MPS	4500	2377 g	38,010.00
Swing Out Rotor 32 × 06 ml	100UC3A3206MLS	4500	3164 g	27,120.00
Swing Out Rotor 4 × 100 ml (with lid)	100UC3A0401LMS	4500	3164 g	30,870.00
Fixed Angle Rotor 16 × 15 ml	100UC3A1615MLF	6000	4910 g	26,210.00
Fixed Angle Rotor 6 × 50 ml	100UC3A0650MLF	6000	4910 g	20,360.00
Fixed Angle Rotor 4 × 50 ml	100UC3A0450MLF	6000	4750 g	18,830.00
Fixed Angle Rotor 24 × 15 ml	100UC3A2415MLF	6000	5070 g	26,460.00
Fixed Angle Rotor 4 × 100 ml	100UC3A0401MLF	6000	4628 g	18,830.00
Fixed Angle Rotor 24 × 2 ml	100UC3A2402MLF	15000	21420 g	32,040.00
Fixed Angle Rotor 44 × 2 ml	100UC3A4402MLF	15000	22388 g	40,210.00
Fixed Angle Rotor 4 × 8 × 0.2 ml PCR	100UC3A4802MLF	15000	15397 g	41,900.00
Fixed Angle Rotor 8 × 5 ml	100UC3A0805MLF	15000	18461 g	40,000.00

Cooling Universal Lab Centrifuge

Multi-rotor configuration with high speed operation and variable temperature range for wide range of lab protocol



Technical Data & Ordering Information

Model Name	CULC1504VT
Rotor position (MAX)	4 × 100 ml (fixed & swing out) / 32 × 6 ml (swing out)
Cooling temperature	Up to - 10°C
Max speed (rpm)	15000 rpm
RCF (g)	g varies as per rotor
Display	Large back lit LCD display
Motor type	Brushless DC motor
Speed setting	500 to 15000 rpm
Lid lock safety	Yes
Imbalance detection	Yes
Timer setting	30 secs. to 999 mins 59 secs. & infinite mode
Dimension (L × W × H) in mm	705 × 585 × 330
Weight	57 kgs (without rotor)
HSN Code	8421999
Ordering Code*	100CULC1504VT0
Prices / Piece	On Request

* Product is supplied without rotors, add rotors as per your application

Optional Accessories

Description	Ordering Code	Max Speed	Max RCF × g	Prices / Piece ₹
Swing Out Rotor 16 × 15 ml	100UC3A1615MLS	4500	3305 g	21,930.00
Swing Out Rotor 4 × 50 ml	100UC3A0450MLS	4500	3305 g	18,420.00
Swing Out Rotor 4 × 100 ml	100UC3A0401MLS	4500	3305 g	17,830.00
Swing Out Rotor 2 Micro plates	100UC3A0002MPS	4500	2377 g	38,010.00
Swing Out Rotor 32 × 06 ml	100UC3A3206MLS	4500	3164 g	27,120.00
Swing Out Rotor 4 × 100 ml (with lid)	100UC3A0401LMS	4500	3164 g	30,870.00
Fixed Angle Rotor 16 × 15 ml	100UC3A1615MLF	6000	4910 g	26,210.00
Fixed Angle Rotor 6 × 50 ml	100UC3A0650MLF	6000	4910 g	20,360.00
Fixed Angle Rotor 4 × 50 ml	100UC3A0450MLF	6000	4750 g	18,830.00
Fixed Angle Rotor 24 × 15 ml	100UC3A2415MLF	6000	5070 g	26,460.00
Fixed Angle Rotor 4 × 100 ml	100UC3A0401MLF	6000	4628 g	18,830.00
Fixed Angle Rotor 24 × 2 ml	100UC3A2402MLF	15000	21420 g	32,040.00
Fixed Angle Rotor 44 × 2 ml	100UC3A4402MLF	15000	22388 g	40,210.00
Fixed Angle Rotor 4 × 8 × 0.2 ml PCR	100UC3A4802MLF	15000	15397 g	41,900.00
Fixed Angle Rotor 8 × 5 ml	100UC3A0805MLF	15000	18461 g	40,000.00

Centrifuge Tubes

Centrifuge tubes are essential for achieving accurate and reliable results in various laboratory applications. Labquest Centrifuge Tubes are designed to enhance your workflow by providing superior performance across cell culture, cell biology, microbiology, molecular biology, and sample preparation protocols.

- Withstands centrifugal forces up to 20,000g
- Certified DNase, RNase, endotoxin, and pyrogen-free
- Leak-proof design ensuring sample integrity
- Tamper-proof graduations for precise measurements



Product Code	Description	Packing Type	Quantity / Pack	Quantity / Case	Prices / Case ₹
100BCT1500B	15 ml Centrifuge Tube	Bulk	25 Tubes	25 Tubes × 20 Packs	7050.00
100BCT150BS	15 ml Centrifuge Tube, Sterile	Bulk	25 Tubes	25 Tubes × 20 Packs	8960.00
100BCT5000B	50 ml Centrifuge Tube	Bulk	25 Tubes	25 Tubes × 20 Packs	10650.00
100BCT500BS	50 ml Centrifuge Tube, Sterile	Bulk	25 Tubes	25 Tubes × 20 Packs	13150.00

Centrifuge Selection Chart

Model	MCF08VT	MCF12VT	MCF24VT	CLMC24VT	DCF06VT	CCD4000VT	
Feature							
Temperature Range	RT	RT	RT	upto -20 degree	RT	RT	
RPM	1000-6000	500-15000	500-13400	500-15000 rpm	500-6500	500-4000	
RCF	2000 g	15596 g	17040 g	Max 22388 g	3684 g	Max 2270 g	
Time	1-25 mins & infinite	1-99 mins & infinite mode	1-999 mins & infinite mode	30 sec - 999 mins, infinite mode	1-30 mins & infinite mode	1-999 mins & infinite mode	
Display	Digital	Digital	Digital	Digital	Digital	Digital	
Motor Type	AC	BLDC	BLDC	BLDC	BLDC	BLDC	
Noise Level	<55 dB	<60 dB	<60 dB	<60 dB	<60 dB	<65 dB	
Rotor	8 X 1.5/2 ml, PCR Strip	12 X 1.5/2 ml	24 X 1.5/2 ml	Max 5 ml	6 X15 ml	Max 15 ml	
speed setting	100 rpm	100 rpm	100 rpm	100 rpm	100 rpm	± 10 rpm	
Acc time	60 ± 2 sec	60 ± 2 sec	70 ± 5 sec	<72 sec	25 sec	45 sec	
Dec time	50 ± 2 sec	50 ± 2 sec	110 ± 5 sec	<74 sec	39 sec	70 sec	



MCF12VT



CLMC24VT



DCF06VT

Centrifuge Selection Chart

	CCFA250VT	CCH120VT	CCD4504VT	ULC4504VT	ULC420VT	ULC1504VT	CULC1504VT
	RT	RT	RT	RT	RT	RT	upto -10 degree
	500-2500	500-12000	500-4500	500-4500	500-4200	500-15000	500-15000 rpm
	462 g	14118 g	1985 g	Max 3485 g	Varies as per rotor	Max 22388 g	Max 22388 g
	1-99 mins & infinite mode	12mins	1-99 mins	30 sec - 99 mins & infinite mode	30 sec - 99 mins & infinite mode	1-999 mins & infinite mode	30 sec - 999 mins 59 sec , infinite mode
	Digital	Digital	Digital	Digital	Digital	Digital	Digital
	BLDC	BLDC	BLDC	BLDC	BLDC	BLDC	BLDC
	<65 dB	<67 dB	<60 dB	<65 dB	<65 dB	<65 dB	<65 dB
	2 microplate, 96 x 384 wells	24 x up to 75 mm length capillary tube	4 x 50 ml + 4 x 15 ml or 8 x 15 ml	Max 4 x 100 ml	Max 4 x 250 ml	Max 4 x 100 ml	Max 4 x 100 ml
	100 rpm	100 rpm	100 rpm	100 rpm	100 rpm	100 rpm	100 rpm
	30 ± 5 sec	60 ± 5 sec	35 ± 5 sec	30 sec	30 sec	60 sec	60 sec
	20 ± 5 sec	70 ± 5 sec	35 ± 5 sec	30 sec	30 sec	60 sec	60 sec



CCD4504VT



ULC4504VT



CULC1504VT

Ultimate solution for precise heating DRY BATH

The LabQuest Digital Dry Bath provides a dependable and precisely controlled heating environment, ideal for microcentrifuge tubes and laboratory applications. Featuring a high-wattage, microprocessor-regulated heater, this dry bath guarantees accuracy and helps maintain a stable temperature. It is an excellent choice for molecular biology, biochemistry, and clinical research



- LabQuest digital dry bath with aluminum blocks provides a rapid and controlled heating environment in micro centrifuge tubes.
- The high-wattage heater is microprocessor controlled for accurate temperature control
- Temperature is set by adjusting the easy-to-operate rotary knob.
- Interchangeable blocks for requirement of every lab

Dry Baths

LabQuest versatile Dry Bath, offers a wide range of inter changeable blocks to accommodate various tubes and plates



*Representative image Dry Bath LBH010 is supplied without aluminium block

Technical Data & Ordering Information

Model Name	LBH010P
Temperature Range	Ambient +5°C to 130°C
Temperature Accuracy	±0.5°C at 37°C
Display Resolution	±0.1°C
Heating Up Time	<18 min 30°C TO 130°C
Process Timer	0 - 999 min
Temperature Control	PID and Digital Energy Regulator
Unit External Dimensions (W × D × H) in mm	285 × 190 × 156
Cover For Dry Block	UV protection
Power consumptions	200 W
Current Consumption	1A
HSN Code	841989900
Ordering Code	BLFHLBH010P0000000
Prices / Piece	24,500.00

8 well PCR strip of 0.2 ml, 32 wells, φ6.35mm, depth 19mm
BLAALBHPCR3208W004



For 0.5 ml tube, 24 wells, φ8.0mm, depth 25mm
BLAALBH0MW2406W004



FOR 2.0 ml or 1.5ml tube 16 wells of, φ11.0mm, depth 30mm
BLAALBH0MW1604W004



Versatile multi well block for 8 wells of 0.2ml tube, 8 wells of 0.5ml tube, and 8 wells of 2.0ml or 1.5ml tube
BLAALBHVMMW008W004



15 ml tube* 12 wells φ17.3mm, depth 50mm
BLAALBH0MW1204W004



For 50 ml tube* 4 wells, φ29.2mm, depth 50mm
BLAALBH0MW0402W004



Bead bath or water bath block Vol of 300ml*
BLAALBH0MW000BB004



Flat 96 well* plate block
BLAALBH0MW0096W004



* During usage of 15ml, 50ml & 96 well plate blocks, top covers remains open

Recommended Accessories

Description	Ordering Code	Prices / Piece ₹
LBH010 ALU Block - 8 × 4 Well PCR Strip Tube	BLAALBHPCR3208W004	12,480.00
LBH010 ALU Block - 6 × 4 Well, 0.5 ml Tube	BLAALBH0MW2406W004	12,480.00
LBH010 ALU Block - 4 × 4 Well, 1.5 / 2.0 ml Tube	BLAALBH0MW1604W004	12,480.00
LBH010 ALU Block - Multi Versatile Well - 8 Wells	BLAALBHVMMW008W004	12,480.00
LBH010 ALU Block - 4 × 3 Well, 15 ml Tube	BLAALBH0MW1204W004	12,480.00
LBH010 ALU Block - 2 × 2 Well, 50 ml Tube	BLAALBH0MW0402W004	12,480.00
LBH010 ALU Bead Bath / Water bath block (w/o beads)	BLAALBH0MW000BB004	16,680.00
LBH010 ALU FLAT 96 well plate block	BLAALBH0MW0096W004	19,060.00

Orbital Shaker

Maintenance free brushless DC motor for powerful performance under high speed



Technical Data & Ordering Information

Model Name	PL ONE
Type of movement	Orbital
Orbital diameter in mm	2 mm
Number of plates	1
Motor Type	Brushless DC motor
Speed range in rpm	300 RPM to 1800 RPM
Run Time	1 to 99 mins & infinite
Pulse mode	No
Maximum Volume	96 / 384 well plate
Inbuilt Counter balance	Yes
Dimensions (W × D × H)	85 × 127 × 86 mm
Digital Display	Yes
Attachments (included in standard pack)	Replaceable Clamps Form attachment for 20 microtube
HSN Code	84798200
Ordering Code	100PL000100000
Prices / Piece	19,110.00

Orbital Shaker

Maintenance free brushless
DC motor for powerful performance
under high speed



Technical Data & Ordering Information

Model Name	PL FOUR
Type of movement	Orbital
Orbital diameter in mm	3 mm
Number of plates	4
Motor Type	Brushless DC motor
Speed range in rpm	200 RPM to 1200 RPM
Run Time	1 to 999 mins & infinite
Pulse mode	Yes
Maximum Volume	4 × 96 / 384 well plate
Inbuilt Counter balance	Yes
Dimensions (W × D × H)	343 × 88 × 195 mm
Digital Display	Yes
Attachments (included in standard pack)	NA
HSN Code	84798200
Ordering Code	100PL000400000
Prices / Piece	38,910.00

High Capacity Orbital Shaker

Platform Shaker with true orbital & linear reciprocating motion

Program mode for motion, direction speed, time, dwell time, loop operation & sequence.



Technical Data & Ordering Information

Model Name	7500S
Type of movement	Orbital / Linear
Orbital diameter in mm	10
Speed range in rpm	50-300 rpm
Motor type	BLDC
Display	Digital
Run time	1 min to 99.59 hrs
Programable feature	6 programs with each program having 9 sub-programs
Program Looping	Yes
Platform Size (L × W) in mm	330 × 330
Dimensions (W × D × H) in mm	350 × 408 × 99
HSN Code	84798200
Ordering Code	100S0000075000
Prices / Piece	95,520.00

Optional Accessoried - For Shaker 7.5 Kg

Description	Ordering Code	Prices / Piece ₹
Universal platform with adjustable bars (Flask capacity 9 × 250 ml, 6 × 500 ml)	100S00009UPB75	10,460.00
Base plate with 9 plastic clamps : 9 × 250 ml	100S02509BPP75	10,340.00
Base plate with 9 plastic clamps : 9 × 500 ml	100S05009BPP75	11,240.00
Base plate with 9 Stainless steel clamps : 9 × 100 ml	100S01009BPS75	12,740.00
Base plate with 9 Stainless steel clamps : 9 × 250 ml	100S02509BPS75	13,130.00
Base plate with 9 Stainless steel clamps : 9 × 500 ml	100S05009BPS75	15,810.00
Stainless steel Clamp for 100 ml flask	100S01001SSC00	820.00
Stainless steel Clamp for 150 ml flask	100S01501SSC00	820.00
Stainless steel Clamp for 250 ml flask	100S02501SSC00	820.00
Stainless steel Clamp for 500 ml flask	100S05001SSC00	1,520.00
Stainless steel Clamp for 1000 ml flask	100S10001SSC00	2,920.00
Funnel Attachment	100S00000FA075	13,520.00

High Capacity Orbital Shaker

Platform Shaker with true orbital & linear reciprocating motion

Program mode for motion, direction speed, time, dwell time, loop operation & sequence.



Technical Data & Ordering Information

Model Name	15000S	
Type of movement	Orbital / Linear	
Orbital diameter in mm	30, 40, 50	60, 70
Speed range in rpm	50 - 300 rpm	50 - 200 rpm
Motor type	BLDC	
Display	Digital	
Run time	1 min to 99.59 hrs	
Programable feature	6 Programs with each program having 9 subdivision	
Program Looping	Yes	
Platform Size (L × W) in mm	745 × 490	
Dimensions (W × D × H) in mm	625 × 825 × 165	
HSN Code	84798200	
Ordering Code	100S0000150000	
Prices / Piece	On Request	

Optional Accessoried - For Shaker 15 Kg

Description	Ordering Code	Prices / Piece ₹
Universal Platform for 44 × 100 ml, 36 × 250 ml, 25 × 500 ml, 13 × 1000 ml	100S00UP150000	56,850.00
Base Plate for Plastic Clamps for 24 × 250 ml, 24 × 500 ml	100S0BPC150015	37,640.00
Plastic Clamp 1 No 250 ml	100S02501PC015	1,020.00
Plastic Clamp 1 No 500 ml	100S05001PC015	1,290.00
Base Plate for SS Clamps 24 × 100 ml, 24 × 150 ml, 24 × 250 ml	100S0BSC250015	33,810.00
SS Clamp 1 No, 100 ml	100S01001SC015	1,300.00
SS Clamp 1 No, 150 ml	100S01501SC015	1,590.00
SS Clamp 1 No, 250 ml	100S02501SC015	1,590.00
Base Plate for SS Clamps 24 × 500 ml, 8 × 1000 ml	100S0BSC100015	33,810.00
SS Clamp 1 No 500 ml	100S05001SC015	2,210.00
SS Clamp 1 No 1000 ml	100S10001SC015	2,560.00

Incubator

Cooling Incubator with versatile performance

- Compact design for small bench space
- Accommodates flask sizes upto 2L
- Internal power outlet for easy installation of small shakers mixers etc.



Technical Data & Ordering Information

Model Name	INCH0025
Temperature Range	Ambient less 15 °C to 60 °C
Temperature Accuracy	0.5 °C (at 37 °C)
Temperature Uniformity	± 1.5 °C (at 37 °C)
Temperature Increments	± 1°C
Dimensions (L × W × H) in mm	337 × 370 × 475
Capacity	25 L
Weight	6.5 kgs
Power Consumption	240 V
Inner Space for Incubation of Plates & Flask	22 L
HSN Code	84198990
Ordering Code	100INCH0025000
Prices / Piece	76,710.00

Multitube Vortexer

Engineered for cell lysis, mixing suspensions and general sample agitation



Technical Data & Ordering Information

Model Name	MTV012
Orbital Diameter in mm	6
Speed range (rpm)	50 - 2200 rpm
Motor type	BLDC motor
Speed Accuracy	±50 rpm
Operation Mode	Pulse & Continuous mode
Maximum Load	4.0 Kg
Digital time setting	1 min - 999 min & Infinite
Dimensions in mm	450 × 245 × 475
Weight (Kg)	24 Kg
Power	60 W
Power Supply	AC 100-240V, 50/60Hz
	Foam insert for 07ml × 60 Tubes / Foam insert for 15ml × 45 Tubes
	Foam insert for 50 ml × 18 Tubes
HSN Code	84798200
Ordering Code	BLFHMTV01200000000
Prices / Piece	On Request

Optional Accessories for Multitube Vortexer

				
50ml X 18 Tube Holding Foam	15ml X 45 Tube Holding Foam	7ml X 60 Tube Holding Foam	250ml X 6 Tube Holding Foam	100ml X 8 Tube Holding Foam

Description	Ordering Code	Prices / Piece ₹
50ML TUBE HOLDING FOAM	BLA0FOAMMTV0000003	10,950.00
15ML TUBE HOLDING FOAM	BLA0FOAMMTV0000004	10,950.00
7ML TUBE HOLDING FOAM	BLA0FOAMMTV0000005	10,950.00
250ml CONICAL FLASK HOLDING FOAM*	BLA0FOAMMTV0000006	10,950.00
100ml VOLUMETRIC FLASK HOLDING FOAM*	BLA0FOAMMTV0000007	10,950.00

Vortexers







The compact and new-age designed vortex mixer is capable of meeting the mixing requirements of laboratory



Technical Data & Ordering Information

Model Name	BHRMI 1.0
Speed	Up to 2800 rpm
Orbital diameter	6 mm
Motor type	AC motor
Operational mode	Touch, Stand-by & Continuous mode
Feet	Four suction cups
Unit External Dimension (W × D × H) in mm	132 × 160 × 180
Power consumption	55 W
Current consumption	1 A
HSN Code	84798200
Ordering Code	BLFHVMX01000000000
Prices / Piece	11,030.00

Optional Accessories for BHRMI 1.0

Accessories for 96 (Well Plates) Ordering code (Combine) BLAHVMX02060000000		Accessories for (volumetric Flask) Ordering code (Combine) BLA0EVA000FOAM0VMX	
			
Microplate holder	Well plate locking belt		
		Volumetric Flask Belt Locker	Foam Holder

Description	Ordering code	Accessories 1.0
Rubber Cup	BLAHVMX01040000000	Included
Flat Foam	BLAHVMX01050000000	
Vial Holder	BLAHVMX01000000001	
Foam Holder	BLAHVMX01010000007	
EVA Vial Holder foam	BLAHVMX02060000000	Optional
Attachment Volumetric Flask	BLA0EVA000FOAM0VMX	

Vortexers







The compact and new-age designed vortex mixer is capable of meeting the mixing requirements of Laboratory



Technical Data & Ordering Information

Model Name	BHRMI 2.0
Speed	Upto 2800 rpm
Orbital diameter	6 mm
Motor type	BLDC motor
Operational mode	Touch, Stand-by & Continuous mode
Timer Setting	0 - 999 min
Display	LED with timer
Feet	Four suction cups
Unit External Dimension (W × D × H) in mm	132 × 160 × 180
Power consumption	56 W
Current consumption	1.5 A
HSN Code	84798200
Ordering Code	BLFHVMX02000000000
Prices / Piece	15,120.00

Optional Accessories for BHRMI 1.0

Accessories for 96 (Well Plates) Ordering code (Combine) BLAHVMX02060000000		Accessories for (volumetric Flask) Ordering code (Combine) BLA0EVA000FOAM0VMX	
 Microplate holder	 Well plate locking belt	 25, 50, 100ml Volumetric Flask Belt	 Volumetric flask Base foam
		 Volumetric Flask Belt Locker	 Foam Holder

Description	Ordering Code	Accessories 2.0
Rubber Cup	BLAHVMX01040000000	Included
Flat Foam	BLAHVMX01050000000	
Vial Holder	BLAHVMX01000000001	
Foam Holder	BLAHVMX01010000007	
EVA Vial Holder foam	BLAHVMX02060000000	Optional
Attachment Volumetric Flask	BLA0EVA000FOAM0VMX	

Laboratory Process Chemistry Series

Introducing cutting-edge glass reactors with full automation from India's leading scientific glass manufacturer. we present state-of the-art automation for lab reactors, empowering researchers to optimize experiments and expedite work flows.

Our solutions ensure accurate and dependable control over essential reactor variables like temperature, pressure, and stirring speed.

We customize your needs with our exclusive range, including block based carousels, bath-based spherical reactors, bench-top cylindrical reactors, and pilot plants, offering a comprehensive selection.

Key Features:

- Process Consultation & Design
- Services Automation & System
- Integration CGMP Compliance ATEX Proof System
- HAZOP Compatible Customizable Solutions
- Documentation

From Bench to Scale up

The Complete Reactor Line for Every Stage of Your Chemical Synthesis



Block Reactor System

Pixel Series



Mini Bath Reactor

Sphere Series



Jacketed Bench Reactor

*Academix Switch
Precision Prime
Series*



Jacketed Pilot Reactor

Comet Series



UV Reactor

Radiance Series

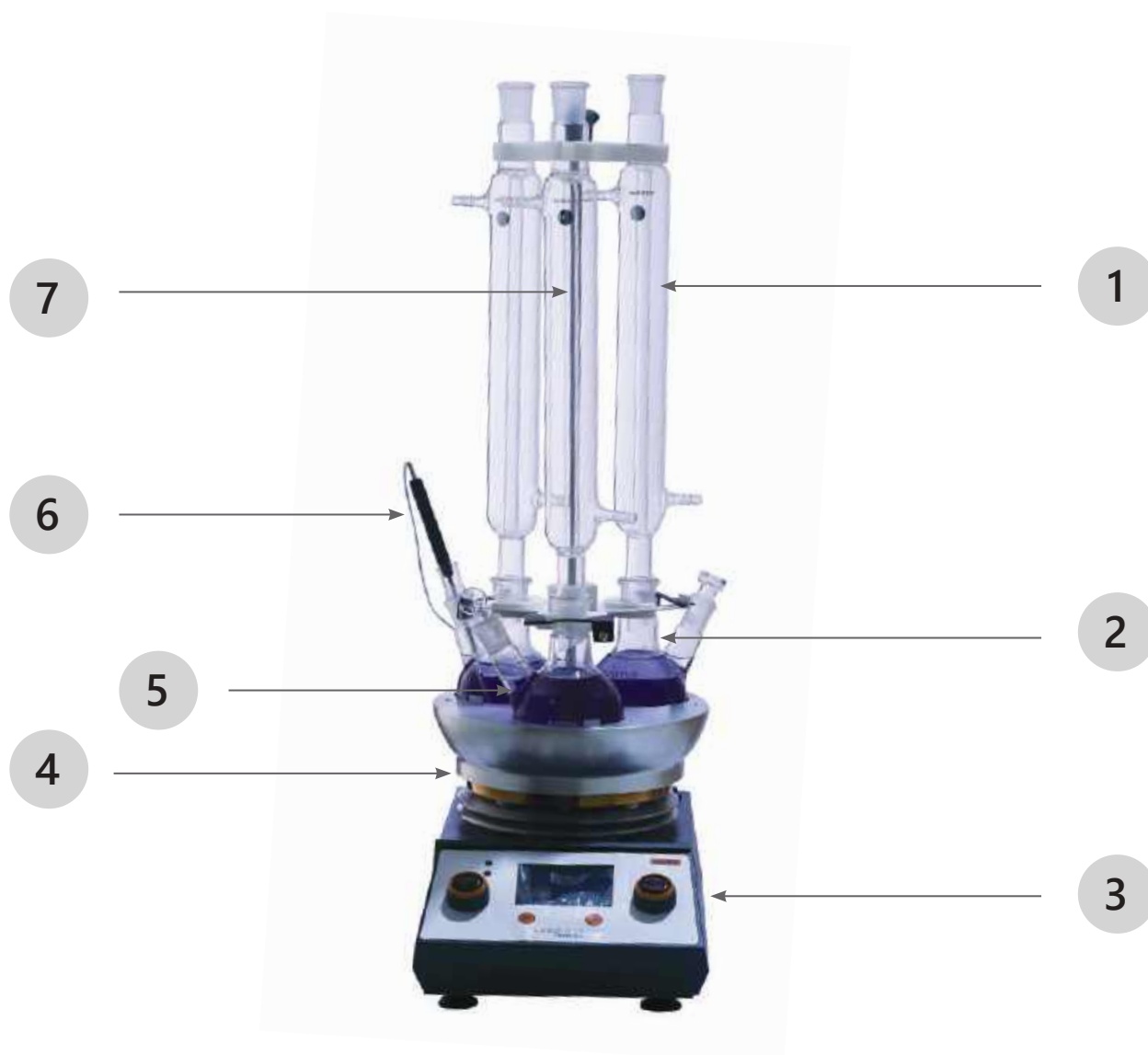

Sr. No.	Description	Part Code / Ref
1	Condenser	Table No. 21
2	Round Bottom Flask	Table No. 20
3	Hot Plate Stirrer	-
4	Heating Block	Table No. 19
5	Magnetic Stir Bar	Table No. 22
6	Temperature Probe	Table No. 23
7	Retort Rod	-

Introducing the BRS from our Pixel Series, the first building block in reaction chemistry and drug discovery. The BRS features a dynamic hot plate system, replacing traditional block-based setups with a versatile carousel for handling parallel reactions from 10ml to 250ml. It can also be used for scale up efficiently to handle 500ml to 5 liters as a single-position heating block. Designed as a safe and efficient alternative to heating mantles, the BRS facilitates easy assembly with condensers and vacuum capabilities, making it an ideal choice for scalable, precise, and adaptable research applications.

Assembly Code	Capacity	Temperature °C	Pressure Range	L x B x H mm
BLFRBRS010XP000000	10 mL	ambient to 200	Upto 0.5 barg	220 x 360 x 850
BLFRBRS025XP000000	25 mL	ambient to 200	Upto 0.5 barg	220 x 360 x 850
BLFRBRS050XP000000	50 mL	ambient to 200	Upto 0.5 barg	220 x 360 x 850
BLFRBRS100XP000000	100 mL	ambient to 200	Upto 0.5 barg	220 x 360 x 850
BLFRBRS250XP000000	250 mL	ambient to 200	Upto 0.5 barg	220 x 360 x 850
BLFRBRS5001P000000	500 mL	ambient to 200	Upto 0.5 barg	220 x 360 x 850
BLFRBRS0011P000000	1 L	ambient to 200	Upto 0.5 barg	220 x 360 x 850
BLFRBRS0021P000000	2 L	ambient to 200	Upto 0.5 barg	220 x 360 x 850
BLFRBRS0031P000000	3 L	ambient to 200	Upto 0.5 barg	220 x 360 x 850
BLFRBRS0051P000000	5 L	ambient to 200	Upto 0.5 barg	220 x 360 x 850

** X=Multi Positions,
500mL, 1 L, 2L, 3L & 5L are single position
Customization are available as per requirements.

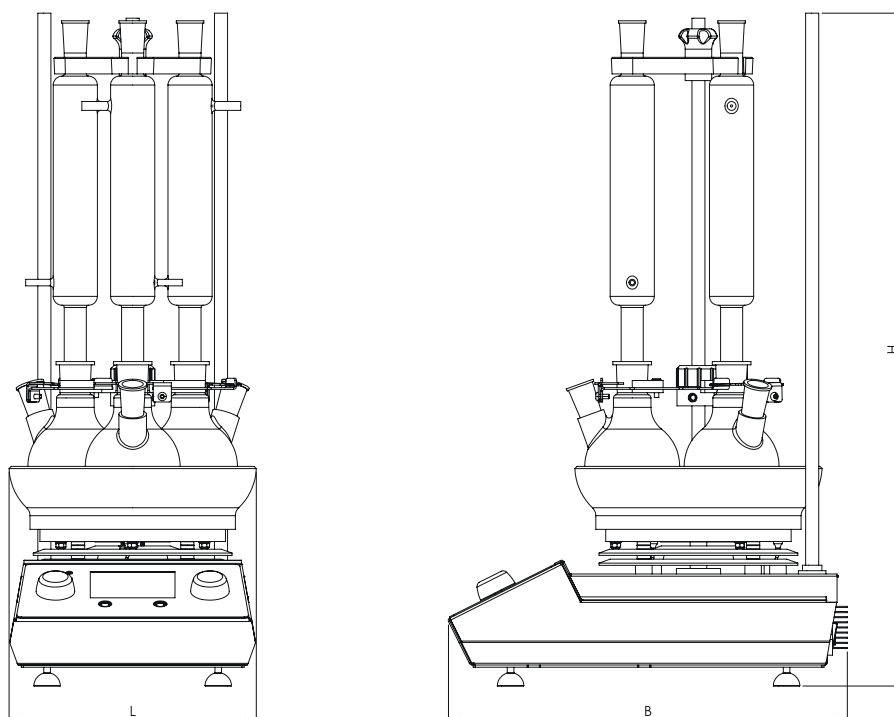

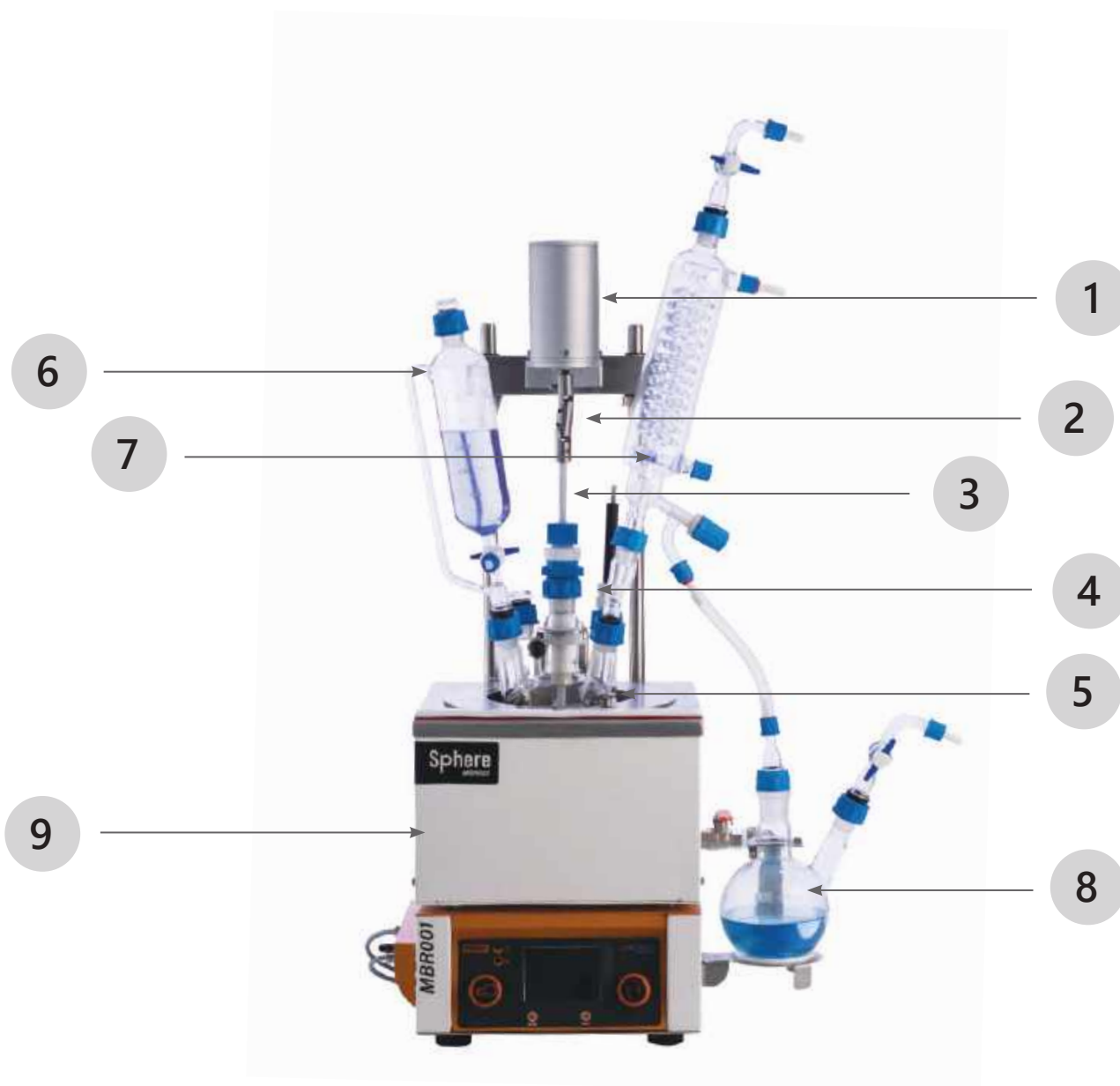

Sr. No.	Description	Qty	Part Code / Ref
1	Agitator Drive	1	-
2	Universal Coupling	1	Table No. 15
3	Stirrer Shaft	1	Table No. 14.4
4	Vacuum Seal	1	Table No. 16
5	Flat Bottom Vessel	1	Table No. 24
6	Dosing Funnel	1	Table No. 8
7	Condenser	1	Table No. 7
8	Receiving Flask	1	Table No. 9
9	Skid with Bath and Control unit	1	-

The MBR part of our Sphere Series, is designed for applications using spherical flask reactors. Equipped with a built-in heater and stirrer with unified control, the MBR001 offers ease of use and rapid setup, making it the go-to choice for demanding reactions. Its streamlined assembly means you can get started quickly, increasing your productivity from the outset.

Ideal for parallel reactions, the MBR allows multiple units to be placed in a single fume hood, significantly boosting your hit rate by enabling independent reaction systems to operate simultaneously. By maximizing your ability to conduct multiple reactions concurrently, the MBR ensures you get the most value out of your laboratory space and resources.

Assembly Code	Capacity	Temperature °C	Pressure Range	L x B x H mm
BLFRMBR2500000000	250 mL	ambient to 200	Upto 0.5 barg	480 x 300 x 750
BLFRMBR5000000000	500 mL	ambient to 200	Upto 0.5 barg	480 x 300 x 750
BLFRMBR00100000000	1 L	ambient to 200	Upto 0.5 barg	480 x 300 x 750
BLFRMBR00200000000	2 L	ambient to 200	Upto 0.5 barg	600 x 600 x 1000
BLFRMBR00300000000	3 L	ambient to 200	Upto 0.5 barg	600 x 600 x 1000
BLFRMBR00500000000	5 L	ambient to 200	Upto 0.5 barg	600 x 600 x 1000

** Customization are available as per requirements.

** Provision for ss cooling coil is available.

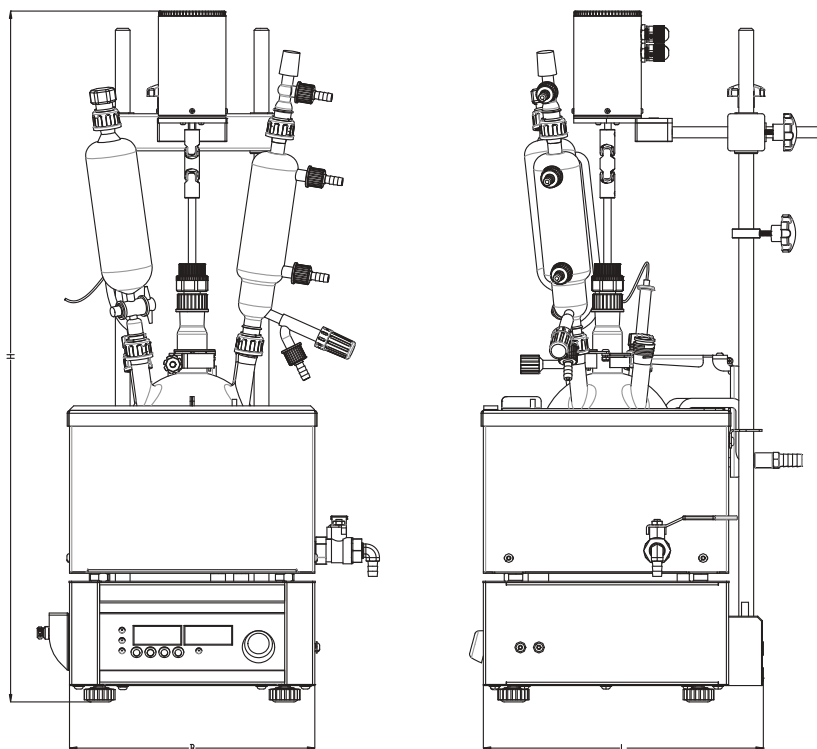

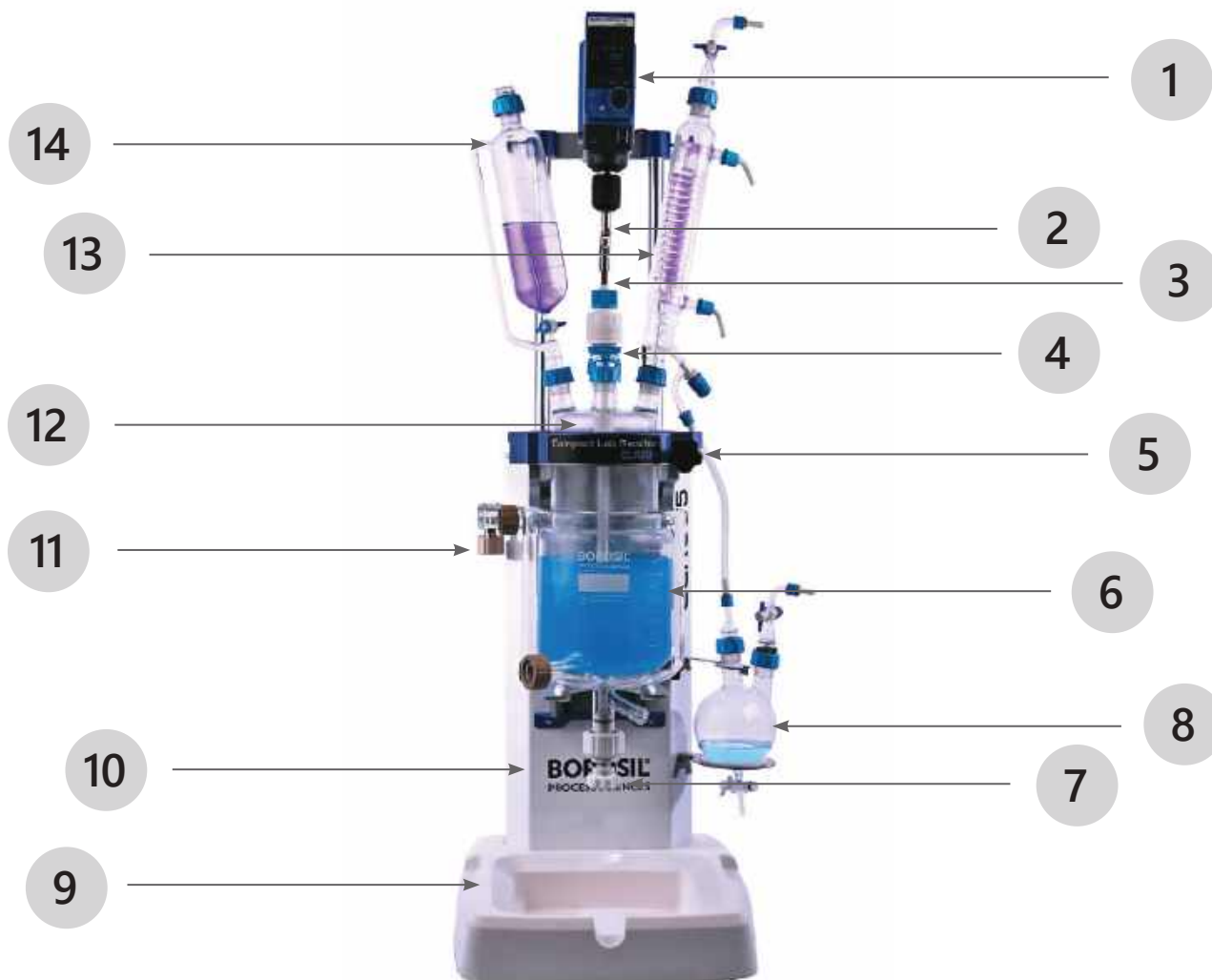

Sr. No.	Description	Qty	Part Code / Ref
1	Agitator drive	1	Table No. 26
2	Universal coupling	1	Table No. 15
3	Agitator shaft	1	Table No. 14
4	Vacuum seal	1	Table No. 16
5	Integrated neck clamp	1	-
6	Reactor vessel	1	Table No. 1/2/3/4
7	PTFE Flush bottom valve	1	Table No. 12
8	Receiver vessel	1	Table No. 9
9	Drip tray	1	Table No. 17
10	Skid	1	-
11	Hose tidy	2	-
12	Lid	1	Table No. 5/6
13	Condenser	1	Table No. 7
14	Feeding funnel	1	Table No. 8

A premium compact lab reactor designed for unmatched performance and seamless user experience. With its precise 1.25 L/D ratio, it mirrors the efficiency of pilot and plant-scale reactions, ensuring optimal mixing every time. Built with advanced reaction systems, PRIME outperforms imported alternatives by offering improved usability and superior handling. The united neck clamp eliminates tedious neck rings, making loading, washing, and handling remarkably easy. Designed for those who demand excellence, PRIME redefines what a compact lab reactor should be – efficient, user-friendly, and undeniably premium.

Assembly Code	Capacity	Temperature °C	Pressure Range	Flange Dia mm	L x B x H mm	Jacket
BLFRCLR250XJ000000	250 mL	-40 to 250	Upto 0.5 barg	DN 100	480 x 465 x 1150	Single/ Double
BLFRCLR500XJ000000	500 mL	-40 to 250	Upto 0.5 barg	DN 100	480 x 465 x 1150	Single/ Double
BLFRCLR001XJ000000	1 L	-40 to 250	Upto 0.5 barg	DN 100	480 x 465 x 1150	Single/ Double
BLFRCLR002XJ000000	2 L	-40 to 250	Upto 0.5 barg	DN 150	560 x 550 x 1400	Single/ Double
BLFRCLR003XJ000000	3 L	-40 to 250	Upto 0.5 barg	DN 150	560 x 550 x 1400	Single/ Double
BLFRCLR005XJ000000	5 L	-40 to 250	Upto 0.5 barg	DN 150	560 x 550 x 1400	Single/ Double

** X=No. of jackets,

Customization are available as per requirements.

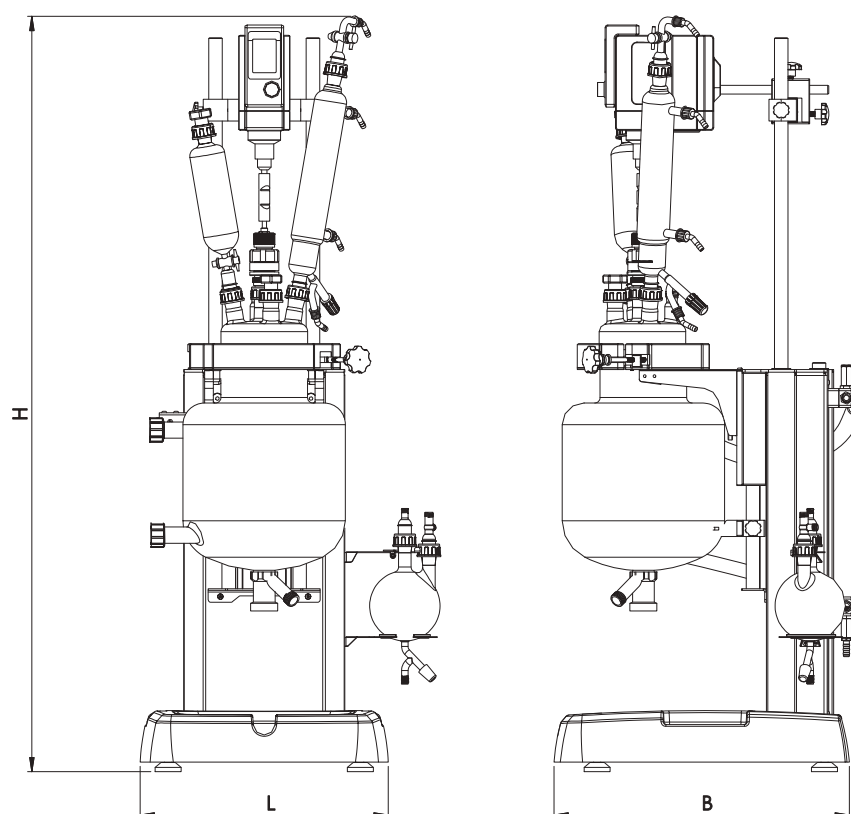

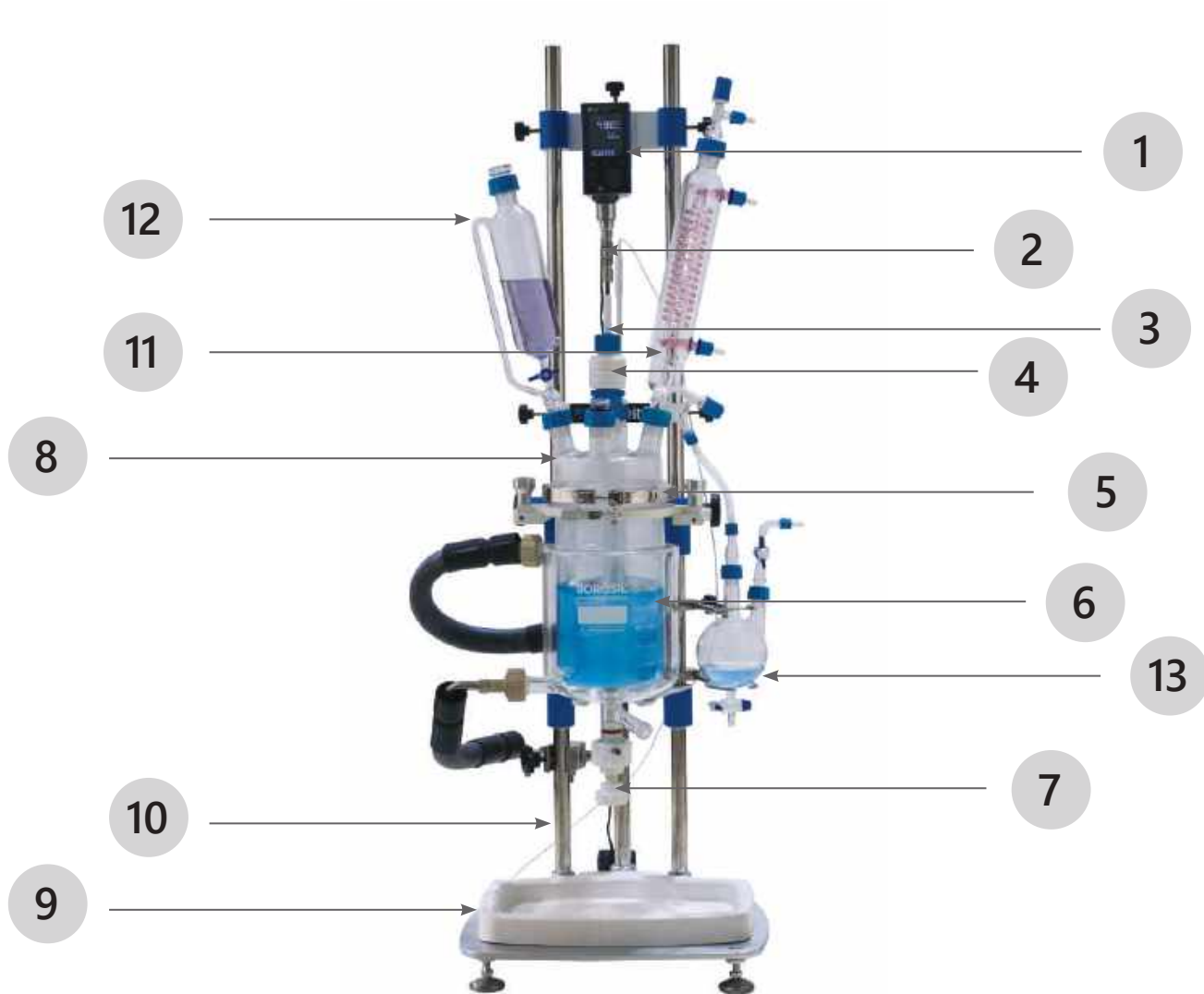

Sr. No.	Description	Qty	Part Code / Ref
1	Agitator drive	1	Table No. 26
2	Universal coupling	1	Table No. 15
3	Agitator shaft	1	Table No. 14
4	Vacuum seal	1	Table No. 16
5	Quick Release Neck Clamp	1	Table No. 18
6	Reactor vessel	1	Table No. 1/2/3/4
7	PTFE bottom valve	1	Table No. 12
8	Lid	1	Table No. 5/6
9	Drip tray	2	Table No. 17
10	Skid	1	-
11	Condenser	1	Table No. 7
12	Feeding funnel	1	Table No. 8
13	Receiver Vessel	1	Table No. 9

The BLR from our Acadamix Series, a jacketed bench reactor tailored specially for students and educational settings. Engineered with ease of handling and rugged durability in mind, the BLR is an ideal choice for fulfilling all academic requirements while remaining economical. Its innovative, lightweight design ensures effortless installation and operation, making it perfect for learning environments. The BLR also offers optional full automation, providing a streamlined and safe reaction process. This product reflects Borosil Scientific's commitment to fostering chemical research and education among students, combining practicality with advanced functionality for an exceptional learning experience.

Assembly Code	Capacity	Temperature °C	Pressure Range	Flange Dia mm	L x B x H mm	Jacket
BLFRBLR250XJ000000	250 mL	-40 to 250	Upto 0.5 barg	DN 100	470 x 452 x 1423	Single/ Double
BLFRBLR500XJ000000	500 mL	-40 to 250	Upto 0.5 barg	DN 100	470 x 452 x 1423	Single/ Double
BLFRBLR001XJ000000	1 L	-40 to 250	Upto 0.5 barg	DN 100	470 x 452 x 1423	Single/ Double
BLFRBLR002XJ000000	2 L	-40 to 250	Upto 0.5 barg	DN 100	470 x 465 x 1423	Single/ Double
BLFRBLR005XJ000000	5 L	-40 to 250	Upto 0.5 barg	DN 150	470 x 465 x 1423	Single/ Double

** X=No. of jackets,

Customization are available as per requirements.

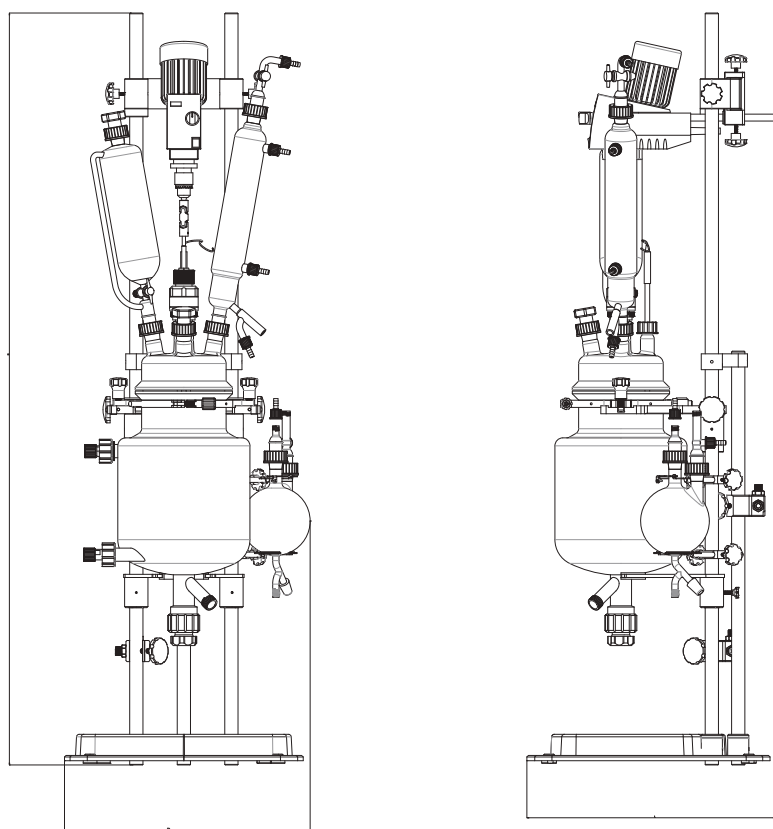

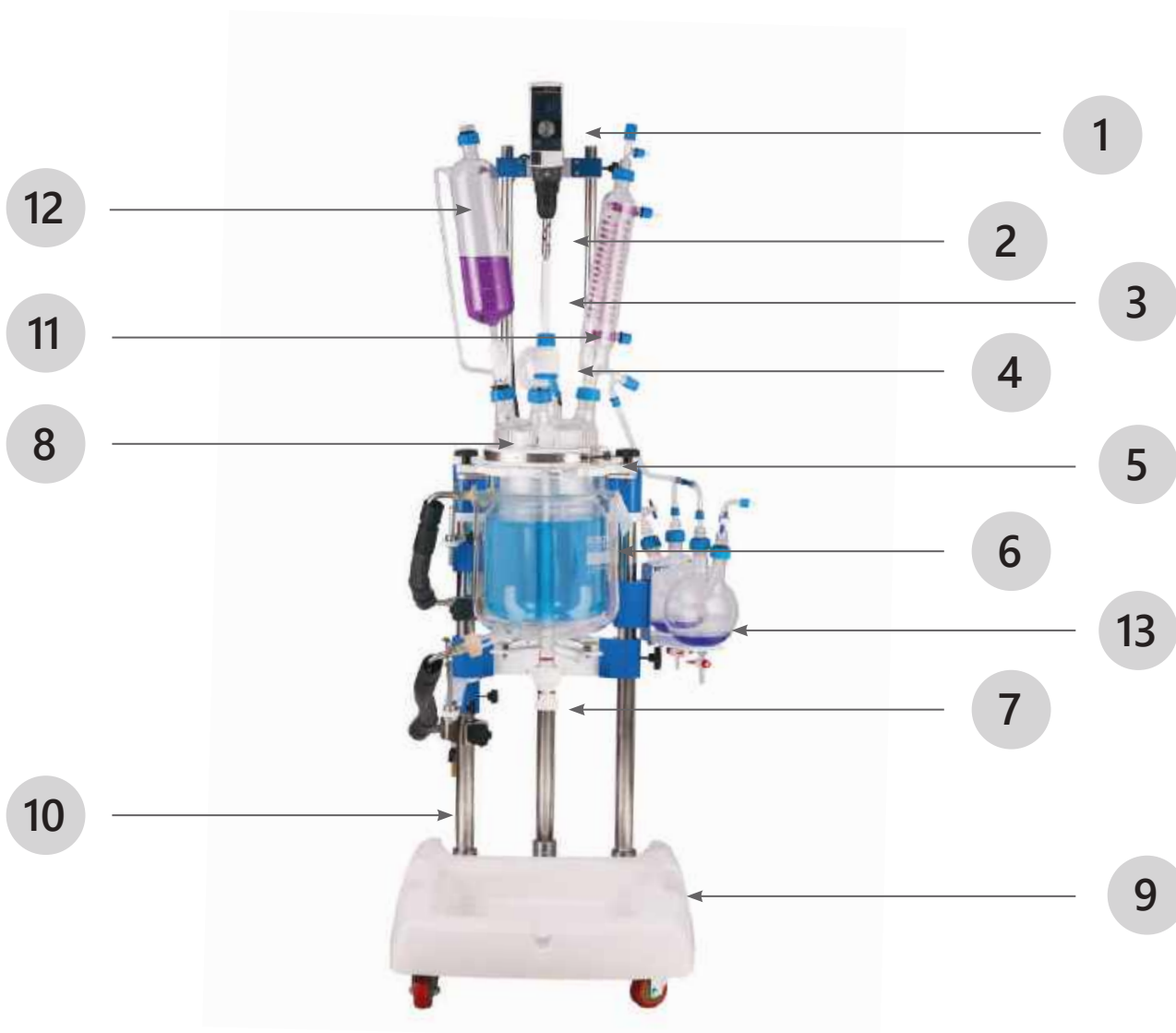

Sr. No.	Description	Qty	Part Code / Ref
1	Agitator drive	1	Table No. 26
2	Universal coupling	1	Table No. 15
3	Agitator shaft	1	Table No. 14
4	Vacuum seal	1	Table No. 16
5	Quick Release Neck Clamp	1	Table No. 18
6	Reactor vessel	1	Table No. 1/2/3/4
7	PTFE bottom valve	1	Table No. 12
8	Lid	1	Table No. 5/6
9	Drip tray	1	Table No. 17
10	Skid	1	–
11	Condenser	1	Table No. 7
12	Feeding funnel	1	Table No. 8
13	Receiver Vessel	1	Table No. 9

Introducing COMET, the pilot lab reactor designed to bridge the gap between laboratory innovation and industrial scalability. Engineered to maintain precise proportions for process scalability, COMET ensures that your experiments translate seamlessly to larger production volumes. With its user-friendly design, handling becomes effortless, enhancing usability for all operators. Offering versatility with low maintenance and skid-mounted designs, COMET also allows easy mobility and integration into any workflow. As the 1st step towards industrial scale-up, COMET facilitates larger reaction scalability, accommodating volumes from 10 to 20 liters. Experience the future of pilot testing with COMET, where every detail is optimized for efficiency and growth in your processes.

Assembly Code	Capacity	Temperature °C	Pressure Range	Flange Dia mm	L x B x H mm	Jacket
BLFRPLR010XJ000000	10 L	-40 to 250	Upto 0.5 barg	DN 150	730 x 740 x 1660	Single/ Double
BLFRPLR015XJ000000	15 L	-40 to 250	Upto 0.5 barg	DN 150	730 x 740 x 1660	Single/ Double
BLFRPLR020XJ000000	20 L	-40 to 250	Upto 0.5 barg	DN 200	740 x 750 x 1660	Single/ Double

** X=No. of jackets,

Customization are available as per requirements.

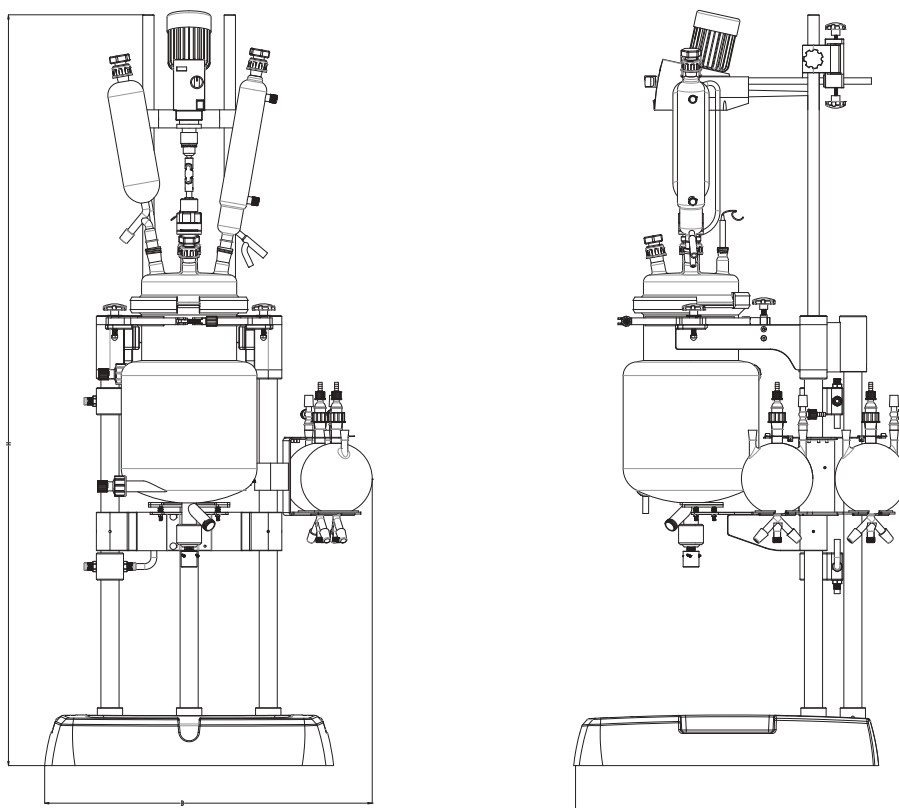

Radiance Batch is a versatile and well-established modular system designed for photochemical experiments in laboratory environments. It accommodates various light sources, such as medium-pressure lamps, 100-watt and 200-watt LEDs, xenon lamps, and low-pressure lamps. The system also includes a built-in heater and stirrer. The Radiance Batch provides specialized photoreactors and radiation sources, ideal for fundamental experiments and feasibility studies on a laboratory scale.



	Specifications
Immersion Well Volume	500 mL
Process Vessel Volume	250ml, 500ml, 1L
Temperature Range	-10°C to 100°C
Glass Type	Quartz and borosilicate glass
Lamp Type	Mercury vapour lamp, Xenon lamp (as per requirement)
Enclosure Dimensions (LxBxH)	515 x 515 x 850 mm
Temperature Sensor	RTD Pt100
Ports	Chiller in and out, Sampling port, Nitrogen purging port

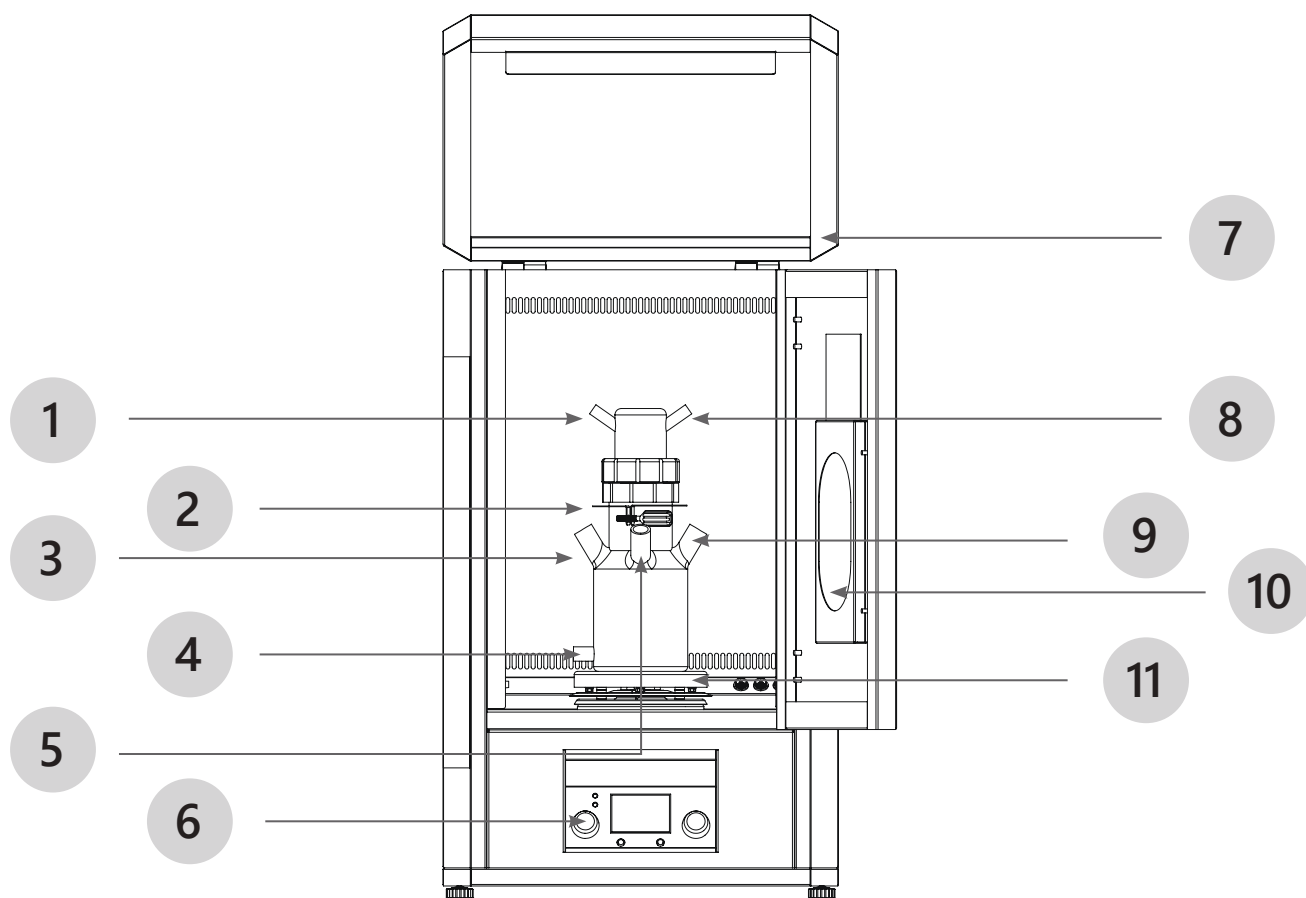

SL. No.	Description
1	Coolant Inlet Port
2	Holding Clamp
3	Substrate Inlet Port
4	Sampling Port
5	Purging Port
6	Process Control Panel
7	Top Openable Panel for Lamp Change
8	Coolant Outlet Port
9	Temperature Probe Port
10	Process Monitoring Window
11	Integrated Hot Plate Stirrer

The **Radiance Flow reactor** offers continuous operation with glass tubes immersed in a temperature- controlled bath, ensuring precise control of photochemical reactions. Its high-power LED or medium- pressure light source maximizes photon efficiency and minimizes losses. Integrated peristaltic pumps simplify setup and control, making the process seamless and user-friendly. This design enables real-time monitoring and process optimization, making it ideal for pharmaceutical applications. By reducing over- irradiation, it minimizes by-products and enhances reaction efficiency. The reactor supports small volumes for early development while maintaining consistent temperatures and flow rates, ensuring smooth and reliable operation.



Specifications	
Vessel Volume Range	5 Litre
Process Vessel Volume	100 millilitre
Temperature Range	0°C to Ambient temperature
Pressure Range	1 bar
Glass Type	Quartz and borosilicate glass
Lamp Type	Mercury vapour lamp, Xenon lamp (as per requirement)
Enclosure Dimensions (LxBxH)	515 x 515 x 850 mm
Temperature Sensor	RTD Pt100
Ports	Chiller in and out, Substrate in and product out port

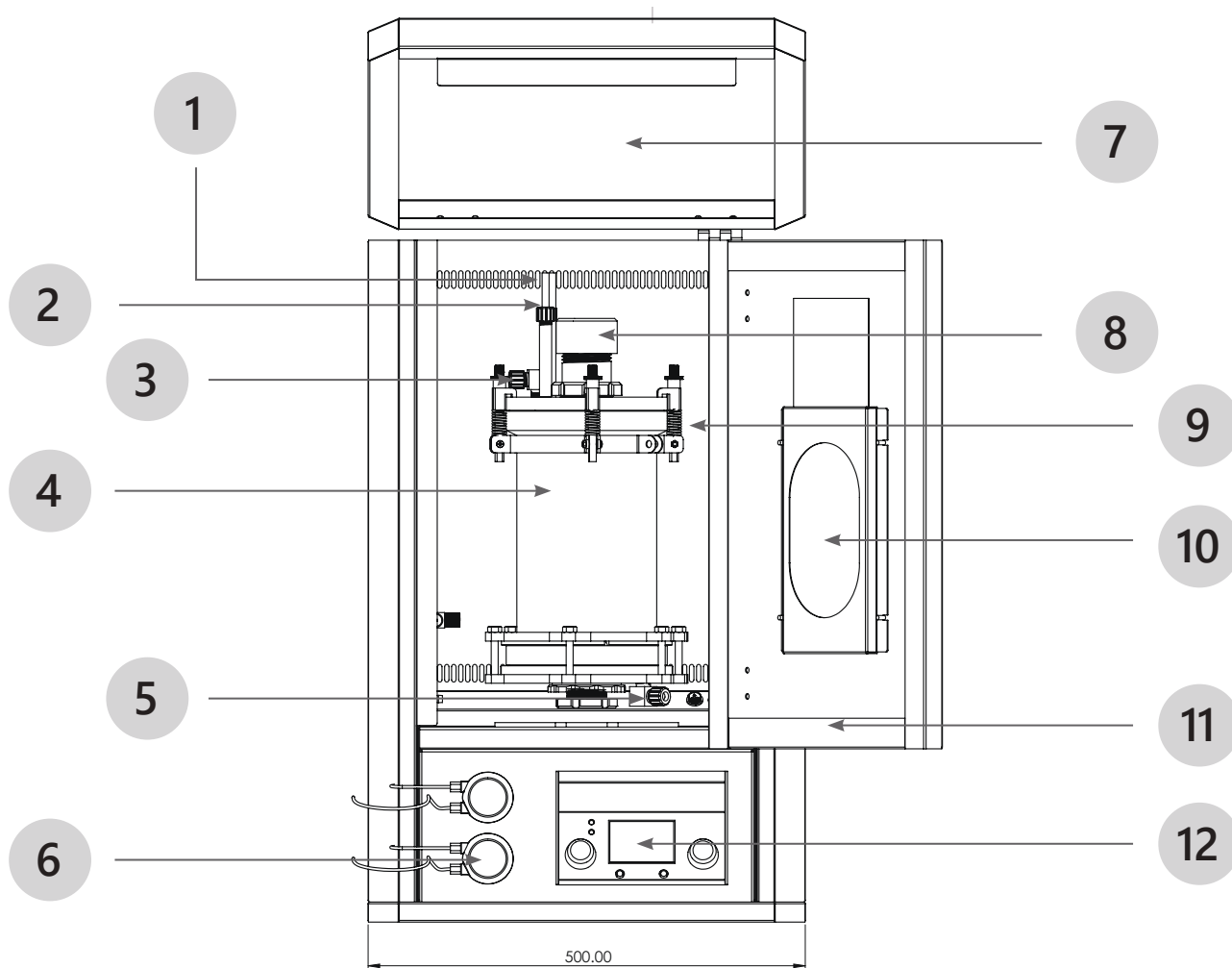

SL. No.	Description
1	Substrate Inlet Port
2	Product Outlet Port
3	Coolant Outlet Port
4	Coolant Vessel
5	Coolant Inlet Port
6	Feeding Pumps
7	Top Openable Panel for Lamp Change
8	Lamp Placement
9	Quick Release Clamps
10	Process Monitoring Window
11	Front door
12	Process Control Panel

Turn Key Projects

Our team of System Integrators, Chemical engineers, Mechanical designers, PLC designers, and Glass experts is capable to deliver any sort of pilot system from 25L Kilo Lab to 250L pilot plant scale projects.

We engage closely with our customers and EPC to design the systems. We also coordinate and integrate all kinds of utilities and services ranging from heating and cooling and vacuum systems, electrical systems, power backups and essential civil work.

We deal with wide range of industries, including food, pharma, oil, chemical and many more...

Our Process

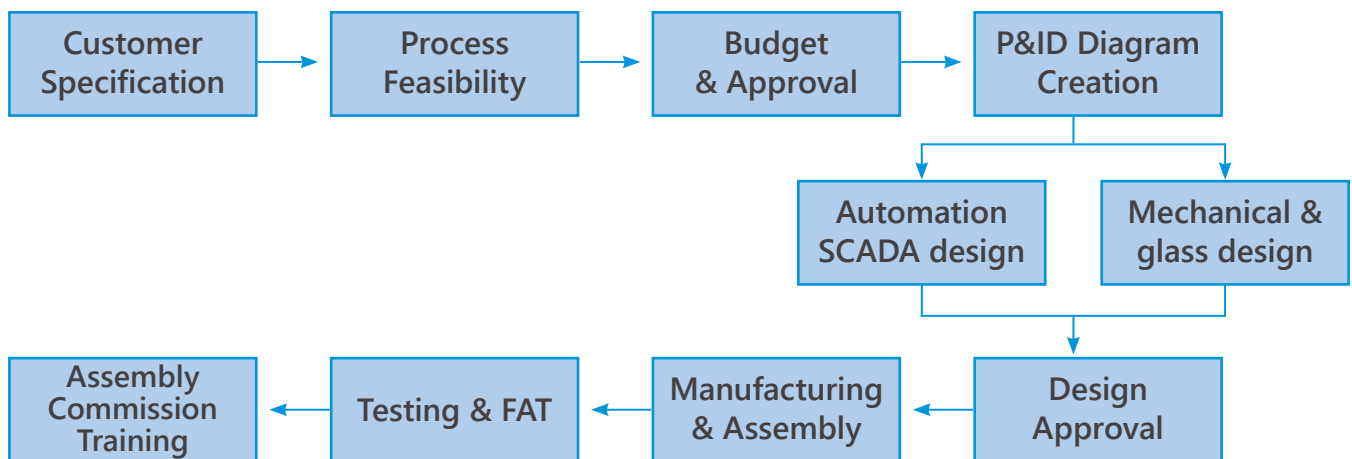

Features

- Pneumatically operated valves
- Automatic dosing
- Gravimetric dosing
- Single point temperature and flow control
- Pressure and vacuum stability

Applications

- Vacuum and Reflux Distillation
- Azeotropic Distillation (Phase Separation)
- Evaporation to any desired consistency
- Multi component reactions
- Reflection / Stripping
- Crystallization
- Low temperature chemistry
- Extraction of multi phase mixture

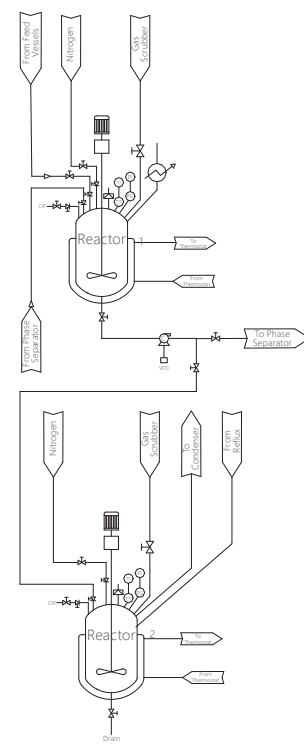

SMART & SCALABLE AUTOMATION SOLUTION

We commit to provide complete automation systems for Lab reactors and ensure that our users achieve absolute peak precision and efficiency in their processes. Our automation systems enable precise control of key parameters such as temperature, stirring speed, and dosing. These systems cater recipe making, real-time monitoring and data logging capabilities, allowing for detailed analysis of reaction performance over time. Our solutions range from PC-based software solutions to dedicated Local & Remote Stations with Customized Machine Interface. We closely interact with our clients to understand their specific requirements and provide customized automation solutions that are tailored to their needs. Our expert team of engineers and technicians provide consultation and support throughout the entire procedure, ensuring that you can achieve the best possible outcomes from our lab and pilot reactor systems.



Precision Engineering

Provides precise control over critical parameters like temperature, pressure, gravimetric addition and mixing, guaranteeing consistent and reliable results



Automation at its Best

Minimizes manual intervention by automating reaction protocols, data logging, and safety measures.

Enhances accuracy and control through an intuitive single-screen interface.



User-Friendly interface

A sleek and intuitive design ensures effortless navigation, enabling users to monitor and adjust reaction parameters like temperature, pressure, and stirring speed in real time.

Precision

- Designed to replicate the exact L/D ratio of plant-scale GLRs
- Predictable scale-ups
- Unequaled precision
- Dish-shaped bottom for High efficiency mixing and heat transfer



Viscous

- Thrives in high-viscosity applications
- Hemispherical bottom vessel accommodates an anchor type agitator and ensures predictable scale up from spherical flask
- Close-to-wall stirring eliminates dead volume.



Reactor Accessories

Reactor Vessel Single Jacketed (Precise Series) – Table No. 1

Part Code	Capacity (L)	Flange Dia mm	Jacket Capacity (L)	HT Area (m ²)
BLARFLK1TG250100V1	0.25	100	0.32	0.03
BLARFLK1TG500100V1	0.5	100	0.42	0.045
BLARFLK1TG001100V1	1	100	0.74	0.064
BLARFLK1TG002150V1	2	150	1.45	0.084
BLARFLK1TG003150V1	3	150	2	0.13
BLARFLK1TG005150V1	5	150	3.12	0.14
BLARFLK1TG010200V1	10	200	4.32	0.2
BLARFLK1TG015200V1	15	200	5.62	0.28
BLARFLK1TG020200V1	20	200	10.56	0.4
BLARFLK1TG025200V1	25	200	11.2	0.4
BLARFLK1TG025300V1	25	300	12.2	0.4
BLARFLK1TG030300V1	30	300	13.48	0.42
BLARFLK1TG035300V1	35	300	14.5	0.5
BLARFLK1TG050300V1	50	300	18.5	0.52

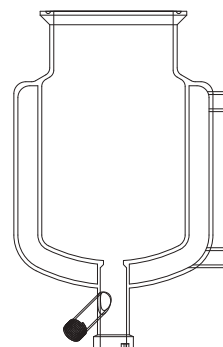

Reactor Vessel Double Jacketed (Precise Series) – Table No. 2

Part Code	Capacity (L)	Flange Dia mm	Jacket Capacity (L)	HT Area (m ²)
BLARFLK2TG250100V1	0.25	100	0.32	0.03
BLARFLK2TG500100V1	0.5	100	0.42	0.045
BLARFLK2TG001100V1	1	100	0.74	0.064
BLARFLK2TG002150V1	2	150	1.45	0.084
BLARFLK2TG003150V1	3	150	2	0.13
BLARFLK2TG005150V1	5	150	3.12	0.14
BLARFLK2TG010200V1	10	200	4.32	0.2
BLARFLK2TG015200V1	15	200	5.62	0.28
BLARFLK2TG020200V1	20	200	10.56	0.4
BLARFLK2TG025200V1	25	200	11.2	0.4
BLARFLK2TG025300V1	25	300	12.2	0.4
BLARFLK2TG030300V1	30	300	13.48	0.42
BLARFLK2TG035300V1	35	300	14.5	0.5
BLARFLK2TG050300V1	50	300	18.5	0.52

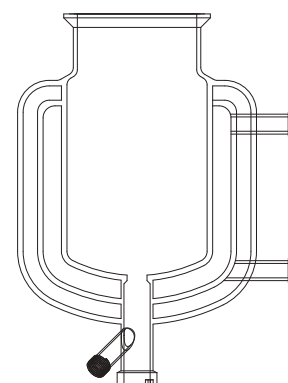

Reactor Accessories

Reactor Vessel Single Jacketed (Viscous Series) – Table No. 3

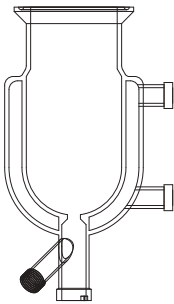

Part Code	Capacity (L)	Flange Dia mm	Jacket Capacity (L)	HT Area (m ²)
BLARFLK1VG250100V1	0.25	100	0.28	0.03
BLARFLK1VG500100V1	0.5	100	0.39	0.045
BLARFLK1VG001100V1	1	100	0.68	0.064
BLARFLK1VG002150V1	2	150	1.40	0.084
BLARFLK1VG003150V1	3	150	1.8	0.13
BLARFLK1VG005150V1	5	150	3.05	0.14

Reactor Vessel Double Jacketed (Viscous Series) – Table No. 4

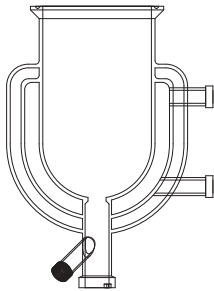

Part Code	Capacity (L)	Flange Dia mm	Jacket Capacity (L)	HT Area (m ²)
BLARFLK2VG250100V1	0.25	100	0.28	0.03
BLARFLK2VG500100V1	0.5	100	0.39	0.045
BLARFLK2VG001100V1	1	100	0.68	0.064
BLARFLK2VG002150V1	2	150	1.4	0.084
BLARFLK2VG003150V1	3	150	1.8	0.13
BLARFLK2VG005150V1	5	150	3.05	0.14

LID Glass Dome Type – Table No. 5

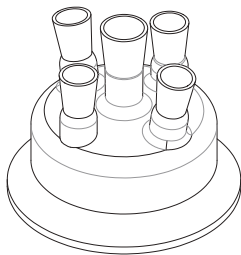

Part Code	Flange Dia mm	No of Nozzles	Centre Nozzle	Side Nozzle	Temperature Sensor Nozzle
BLARLID5FG0DN100V1	100	5	24/29	19/22	19/22
BLARLID5FG0DN150V1	150	5	34/35	29/32	19/23
BLARLID5FG0DN200V1	200	5	34/35	34/35	19/24
BLARLID5FG0DN300V1	300	5	34/35	34/35	19/25

LID PTFE Flat Type – Table No. 6

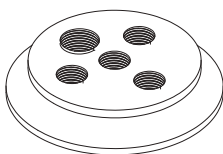

Part Code	Flange Dia mm	No of Nozzles	Centre Nozzle	Side Nozzle	Temperature Sensor Nozzle
BLARLID5TEFDN100V1	100	5	24/29	M25	M25
BLARLID5TEFDN150V1	150	5	34/35	M30	M40

Condenser – Table No. 7

Part Numbers	Size	HT Area	Connection Nozzle Size
BLARCND000D080L520	D80 LEN 520	0.12	34/35
BLARCND000D065L450	D65 LEN 450	0.08	29/32
BLARCND000D060L320	D60 LEN 320	0.05	19/22
BLARCND000D050L260	D50 LEN 260	0.03	19/22

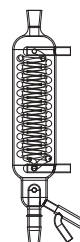

Feeding Funnel – Table No. 8

Part Numbers	Volume Capacity	Connection Nozzle Size
BLARDOF11000MLCOCK	1000 mL	34/35
BLARDOF01000MLCOCK	1000 mL	29/32
BLARDOF00500MLCOCK	500 mL	29/32
BLARDOF00250MLCOCK	250 mL	19/22
BLARDOF00100MLCOCK	100 mL	19/22

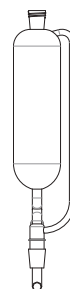

Receiving Vessel – Table No. 9

Part Numbers	Volume Capacity (mL)	Center Nozzle	Side Nozzles
BLARREF00250MLCOCK	250	19/22	19/22
BLARREF00500MLCOCK	500	19/22	19/22
BLARREF01000MLCOCK	1000	29/32	29/32
BLARREF02000MLCOCK	2000	29/32	29/32



Glass Vent Adaptor – Table No. 10

Part Numbers	Nozzle Size
BLARADP0BC1922COCK	19/22
BLARADP0BC2932COCK	29/32

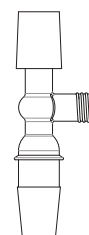

Straight Adaptor – Table No. 11

Part Numbers	Description
BLGRADP0SC2932COCK	STRAIGHT ADAPTOR 29/32
BLGRADP0SC1922COCK	STRAIGHT ADAPTER 19/22



Reactor Accessories

Flush Bottom Valve – Table No. 12

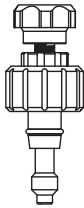

Part Numbers	MOC	Nozzle Type	Nozzle Size
BLARBTV0DN15SL1500	PTFE, PEEK	GL Connection	GL 15
BLARBTV1DN15SL1500	PTFE, PEEK	GL Connection	GL 15
BLARBTV0DN25SL1500	PTFE, PEEK	GL Connection	GL 25
BLARBTV1DN25SL1500	PTFE, PEEK	GL Connection	GL 25

Temperature Sensor ASM – Table No. 13



Part Numbers	Dia (mm)	Length (mm)
BLATEMPROBE200H08D	8	200
BLATEMPROBE300H08D	8	300
BLATEMPROBE400H08D	8	400
BLATEMPROBE500H09D	9	500
BLATEMPROBE600H09D	9	600
BLATEMPROBE700H09D	9	700
BLATEMPROBE900H09D	9	900

Agitator Shafts – Table No. 14

Pitch Blade Turbine Rotor Shaft – Table No. 14.1

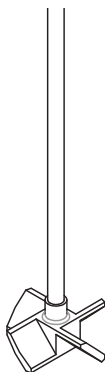

Part Numbers	Length (mm)	Shaft Dia (mm)	Rotor Dia (mm)
BLASTP0300H08D040R	300	8	40
BLASTP0400H08D040R	400	8	40
BLASTP0500H08D050R	500	8	50
BLASTP0550H10D070R	550	10	70
BLASTP0650H10D070R	650EX	10	70
BLASTP0750H10D070R	750EX	10	70
BLASTP0650H12D080R	650EX	12	80
BLASTP0750H12D080R	750EX	12	80
BLASTP1000H12D080R	1000EX	12	100
BLASTP0750H12D080R	750EX	16	80
BLASTP0750H16D100R	750EX	16	100
BLASTP1000H16D100R	1000EX	16	100
BLASTP1000H16D120R	1000EX	16	120

Retreat Curve Shaft – Table No. 14.2

Part Numbers	Length (mm)	Shaft Dia (mm)	Rotor Dia (mm)	Blade Ht (mm)
BLASTR0300H08D050R	300	8	50	10
BLASTR0300H08D075R	300	8	75	15
BLASTR0400H08D050R	400	8	50	10
BLASTR0400H08D075R	400	8	75	15
BLASTR0400H10D050R	400	10	50	10
BLASTR0400H10D075R	400	10	75	15
BLASTR0500H10D050R	500	10	50	10
BLASTR0500H10D075R	500	10	75	15
BLASTR0500H12D125R	500	12	125	18

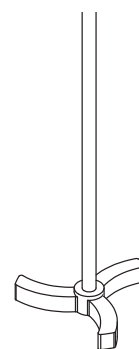

Anchor Rotor Shaft – Table No. 14.3

Part Numbers	Length (mm)	Shaft Dia (mm)	Rotor Dia (mm)
BLASTA0300H08D080R	300	8	80
BLASTA0400H08D080R	400	8	80
BLASTA0500H08D080R	500	8	80
BLASTA0550H10D100R	550	10	100
BLASTA0650H10D140R	650EX	10	140
BLASTA0750H10D140R	750EX	10	140
BLASTA0650H12D140R	650EX	12	140
BLASTA0750H12D140R	750EX	12	140
BLASTA1000H12D140R	1000EX	12	140
BLASTA0750H16D140R	750EX	16	140
BLASTA0750H16D180R	750EX	16	180
BLASTA1000H16D140R	1000EX	16	140
BLASTA1000H16D180R	1000EX	16	180

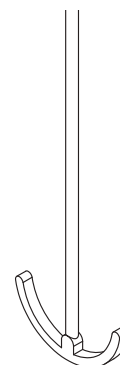

Centrifugal Rotor Shaft – Table No. 14.4

Part Numbers	Length (mm)	Shaft Dia (mm)	Rotor Dia (mm)
BLASTC0300H08D040R	300	8	40
BLASTC0400H08D040R	400	8	40
BLASTC0500H08D050R	500	8	50
BLASTC0550H10D070R	550	10	70
BLASTC0650H10D070R	650EX	10	70
BLASTC0750H10D070R	750EX	10	70
BLASTC0650H12D080R	650EX	12	80
BLASTC0750H12D080R	750EX	12	80
BLASTC1000H12D080R	1000EX	12	80
BLASTC0750H16D080R	750EX	16	80
BLASTC1000H16D080R	1000EX	16	80

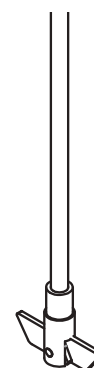

Reactor Accessories

Adjustable Rotor Pitch Blade Type – Table No 14.5

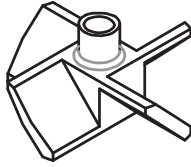

Part Numbers	Shaft Dia (mm)	Rotor Dia (mm)
BLAADJROTPB08D040R	8	40
BLAADJROTPB10D060R	10	60
BLAADJROTPB10D090R	10	90
BLAADJROTPB12D070R	12	70
BLAADJROTPB12D090R	12	90
BLAADJROTPB16D100R	16	100

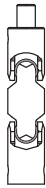

Universal Coupling – Table No. 15

Part Number	RANGE	MOC
BLARUNICOUPO000000	8mm-16mm shafts	SS304



Vacuum Seal – Table No. 16

Part Numbers	Shaft Dia	Cone Joint Size	Height (mm)	Guide Dia (mm)
BLASTRGUIDE2429D08	8	24/29	110	45
BLASTRGUIDE2429D08	8	24/29	96	45
BLASTRGUIDE2429D10	10	24/29	96	45
BLASTRGUIDE3435D10	10	34/35	96	45
BLASTRGUIDE3435D12	12	34/35	110	55
BLASTRGUIDE3435D1	16	34/35	110	55

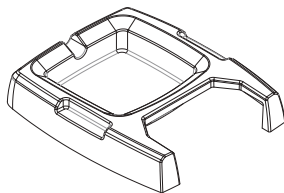

Drip Tray – TABLE No. 17

Part Numbers	Product	MOC
BLADRIPTRAYCLR00PP	Prime Series	FRP
BLADRIPTRAYBLR00PP	Acadamix Series	FRP
BLADRIPTRAYFLR00PP	Comet Series	FRP

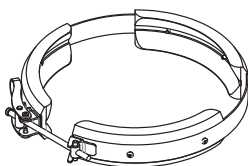

Quick Release Clamp – TABLE No. 18 (For Acadamix Series)

Part Numbers	Flange Dia(mm)
BLAPCLMPDSS3040106	DN60
BLAPCLMPDSS3040146	DN100
BLAPCLMPDSS3040192	DN150
BLAPCLMPDSS3040250	DN200

Heating Blocks – Table No. 19 (For Pixel Series)

Part Numbers	positions	Capacity
BLARBRS001P00HTBL	1	500 mL
BLARBRS0011P00HTBL	1	1 L
BLARBRS0021P00HTBL	1	2 L
BLARBRS0031P00HTBL	1	3 L
BLARBRS0051P00HTBL	1	5 L
BLARBRS010XP00HTBL	Up to 12	10 mL
BLARBRS025XP00HTBL	Up to 10	25 mL
BLARBRS050XP00HTBL	Up to 6	50 mL
BLARBRS100XP00HTBL	Up to 5	100 mL
BLARBRS250XP00HTBL	Up to 3	250 mL

** X=Multi Positions,

500mL, 1 L, 2L, 3L & 5L are single position.

The blocks are available in ceramic, fluoropolymer, PTFE coated, and anodized options.

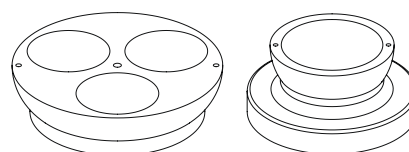

Round Bottom Flask – Table No. 20 (For Pixel Series)

Round Bottom Flask Single Neck – Table No. 20.1

Product Code	Capacity (mL)	Interchangeable Joint
4380A06	10	14 / 23
4380A09	25	14 / 23
4380B09	25	19 / 26
4380A12	50	14 / 23
4380B12	50	19 / 26
4380C12	50	24 / 29
4380D12	50	29 / 32
4380E12	50	34 / 35

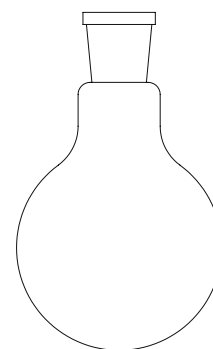

Round Bottom Flask Two Neck – Table No. 20.2

Product Code	Capacity (mL)	Interchangeable Joint	
		Centre Neck	Side Neck
4381A16	100	19 / 26	14 / 23
4381B16	100	24 / 29	14 / 23
4381C16	100	24 / 29	19 / 26
4381A21	250	24 / 29	14 / 23
4381B21	250	24 / 29	19 / 26
4381A24	500	24 / 29	14 / 23
4381B24	500	24 / 29	19 / 26
4381A29	1000	24 / 29	14 / 23
4381B29	1000	24 / 29	19 / 26
4381A30	2000	24 / 29	14 / 23
4381B30	2000	24 / 29	19 / 26
4381C30	2000	34 / 35	19 / 26
4381A31	3000	34 / 35	19 / 26
4381B31	3000	34 / 35	24 / 29
4381A33	5000	34 / 35	19 / 26
4381B33	5000	34 / 35	24 / 29

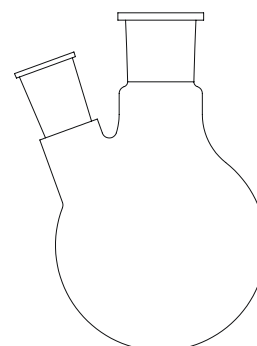

Reactor Accessories

Round Bottom Flask Three Neck – Table No. 20.3

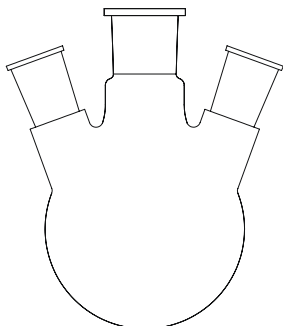

Product Code	Capacity (mL)	Interchangeable Joint		
		Centre Neck	Side Neck	Side Neck
4383A24	500	19 / 26	14 / 23	14 / 23
4383B24	500	19 / 26	19 / 26	19 / 26
4383C24	500	24 / 29	14 / 23	14 / 23
4383D24	500	24 / 29	19 / 26	19 / 26
4383A29	1000	24 / 29	14 / 23	14 / 23
4383B29	1000	24 / 29	19 / 26	19 / 26
4383C29	1000	34 / 35	24 / 29	24 / 29
4383D29	1000	34 / 35	19 / 26	19 / 26
4383A30	2000	24 / 29	14 / 23	14 / 23
4383B30	2000	24 / 29	19 / 26	19 / 26
4383C30	2000	34 / 35	19 / 26	19 / 26
4383D30	2000	34 / 35	24 / 29	24 / 29
4383A31	3000	34 / 35	19 / 26	19 / 26
4383B31	3000	34 / 35	24 / 29	24 / 29
4383A33	5000	34 / 35	19 / 26	19 / 26
4383B33	5000	34 / 35	24 / 29	24 / 29
4383C33	5000	45 / 40	24 / 29	24 / 29

Condenser – Table No. 21 (For Pixel Series)

Liebig Condenser – Table No. 21.1

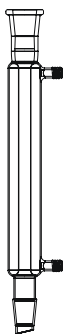

Product Code	Approx Jacket Length mm	Approx Overall Height mm	Ground Joint	
			Socket	Cone
2400087	200	350	19 / 26	19 / 26
2400A87	200	350	24 / 29	24 / 29
2400090	300	450	24 / 29	24 / 29
2400A90	300	450	19 / 26	19 / 26
2400092	400	550	24 / 29	24 / 29
2400A92	400	550	19 / 26	19 / 26

Allihn Condenser – Table No. 21.2

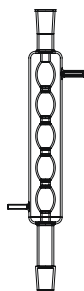

Product Code	Approx Jacket Length mm	Approx Overall Height mm	Ground Joint	
			Socket	Cone
2480087	200	350	19 / 26	19 / 26
2480A87	200	350	24 / 29	24 / 29
2480090	300	450	24 / 29	24 / 29
2480A90	300	450	19 / 26	19 / 26
2480092	400	550	24 / 29	24 / 29
2480A92	400	550	29 / 32	29 / 32
2480096	600	750	29 / 32	29 / 32
2480A96	600	750	24 / 29	24 / 29

Graham Coiled Condenser – Table No. 21.3

Product Code	Approx Jacket Length mm	Approx Overall Height mm	Ground Joint	
			Socket	Cone
2560090	300	450	24 / 29	24 / 29
2560A90	300	450	19 / 26	19 / 26
2560092	400	550	24 / 29	24 / 29
2560A92	400	550	29 / 32	29 / 32
2560095	500	650	24 / 29	24 / 29
2560A95	500	650	29 / 32	29 / 32

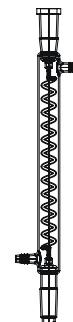

Magnetic Stir Bar – Table No. 22 (For Pixel Series)

Part Numbers	Diameter mm	Length mm
BLM0MSB0000002508D	8	25
BLM0MSB350A01PR13D	13	35

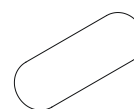

Temperature Sensor – Table No. 23 (For Pixel Series)

Part Numbers	Diameter mm	Length mm
BLE0RTD3WPT1000STM	3	155
BLE0DIN0HLSCON0ASM	4	150



Flat Bottom Flask – Table No. 24 (For Sphere Series)

Part Numbers	Volume Capacity (ML)	No of Nozzles	Center Nozzle Type	Side Nozzle Type	Solid dosing Port
BLARFLK00250ML00FB	250	5	B24	B19	-
BLARFLK00500ML00FB	500	5	B24	B19	-
BLARFLK01000ML00FB	1000	5	B24	B19	-
BLARFLK02000ML00FB	2000	6	B34	B19 & B24	GL45
BLARFLK03000ML00FB	3000	6	B34	B19 & B24	GL45
BLARFLK05000ML00FB	5000	6	B34	B19 & B24	GL45

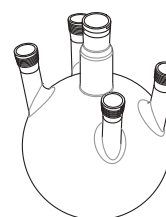

SS Circulation Coil – Table No. 25 (For Sphere Series)

Part Numbers	Description
BLACIRCOIL00MBR001	MBR Circulation coil for 1L
BLACIRCOIL00MBR005	MBR Circulation coil for 5L

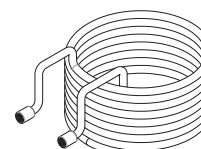

Reactor Utilities

Agitator Drive - IKA

Designed to optimize complex stirring applications, IKA offers the very best in overhead stirrer technology. Our overhead stirrers provide the perfect solution to all your laboratory stirring and mixing needs, from lower to higher viscosities. IKA overhead stirrers process stirring quantities up to 200 liters. The IKA overhead stirrers also display temperature of the media.



Part Numbers	Model	Speed Range (rpm)	Torque (Ncm)	Max Viscosity (mPas)	Max Stirred Volume (L)
BLAIKARW2000000000	RW20	2000	150	10,000	20
BLAIKAEURO60CONTRL	EUROSTAR 60 control	2000	60	50,000	40
BLAIKAEUR100CONTRL	EUROSTAR 100 control	1300	100	70,000	100
BLAIKAEUR200CONTRL	EUROSTAR 200 control	2000	200	100,000	100

Heating & Cooling Circulator – HUBER

Successful working of reactor is depending on the right selection of Heating & Cooling Circulator. The quality of temperature control is highly dependent on the speed at which the jacket temperature can be changed. For best possible heat transfer rates, unistats produce a high delta-T between jacket temperature and reactor contents. Glass reactors are inherently sensitive to pressure (typically the maximum allowable jacket pressure is 0.5 bar) and thermal shock (caused by the temperature difference between the jacket and the reaction mass). Unistats have variable pressure control (VPC) and a delta-T limit to protect against both. In addition, the “process safety” function ensures that the pump and cooling system continue to operate in the event of an over temperature shutdown. This can, for example, prevent overheating of the reactor contents during an exothermic reaction



Reactor	Part Numbers	Model	Temp Range °C	Pump Max (L/min, bar)	Heating capacity KW	Cooling capacity KW @ 0 °C	Dimensions W x D x H (mm)
Up to 2L	BLAHUBER002MINI230	Ministat 230	-40..200	22,0,7	1.6-2.1	0.38	255x450x476
	BLAHUBER002TANGO00	Tango	-40..250	55,0,9	3	0.7	426x327x631
	BLAHUBER002UNI0705	Unistat 705	-75..250	55,0,9	1.5	0.65	425x400x720
5L	BLAHUBER005UNI0405	Unistat 405	-40..250	55,0,9	3	1	426x327x631
	BLAHUBER005UNI0705	Unistat 705	-75..250	55,0,9	1.5	0.65	425x400x720
	BLAHUBER005UNI0815	Unistat 815	-85..250	40,0,9	2	1.5	460x604x1465
10L	BLAHUBER010UNI0425	Unistat 425	-40..250	91,1,5	2	2.5	460x554x1453
	BLAHUBER010UNI0815	Unistat 815	-85..250	40,0,9	2	1.5	460x604x1465
	BLAHUBER010UNI0825	Unistat 825	-85..250	40,0,9	3	2.2	460x604x1465
20L	BLAHUBER020UNI510W	Unistat 510w	-50..250	112,0,9	6	5.3	460x554x1453
	BLAHUBER020UNI0905	Unistat 905	-90..250	48,0,9	6	3.6	540x654x1500
30L	BLAHUBER030UNI510W	Unistat 510w	-50..250	112,0,9	6	5.3	460x554x1453
	BLAHUBER030UNI912W	Unistat 912w	-90..250	110,1,5	6	7	630x704x1565

BOROSIL[®] Scientific

Industrial Scientific Process Glass Equipments,
Components & Spares



A BOROSIL SCIENTIFIC Company

Agitated Nutsche Filter

10L to 300L Capacity

Multipurpose Glassware Unit

20L to 500L Capacity

Peptide Synthesizer

10L to 300L Capacity

Glass Packed Column

Upto 600DN Capacity

High Pressure Glass Reactor

Pressure Upto 10 Bar

Complete Solution for Industrial Glassware

In industrial Glassware, Our Products include Scientific Glass Equipment, Glass Reactors, Glass Columns, Rotary Evaporators, Kilo lab units, Reagent Bottles, Glass Heat Exchangers, Glass Pipe Components, Glass Valves, Jacketed Reactors, High-Pressure Glass Reactors, Custom Glassware etc.

Goel Scientific Glass Works Ltd.

Please contact CT Enterprises for quotation.

Email: sales@ctenterprises.in | Phone: +91 8977721310

Standard Units

Glass Reactor with Metal Jackets

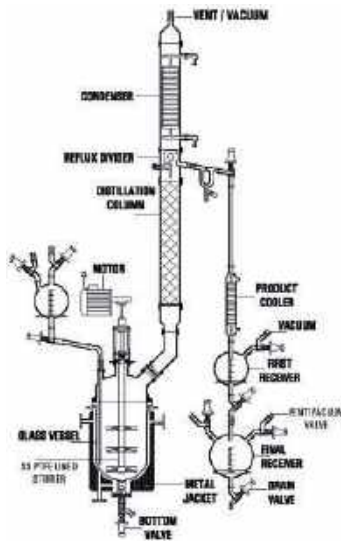

Glass Metal jacketed Reactor 5-200 liter
Pressure: - up to 1 Bar
Temperature: -50°C to +200°C
Material: Borosilicate glass 3.3 /PTFE/ SS 316.

Simple Distillation Unit

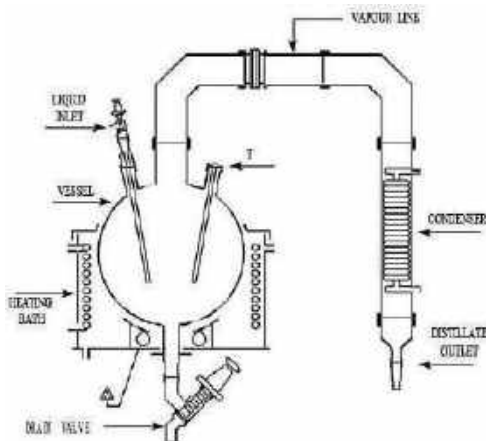

The units are available in vessel sizes of 20, 50, 100, 200, 300 & 500 L and is suitable for operation under atmospheric pressure and full vacuum.

Reaction Unit

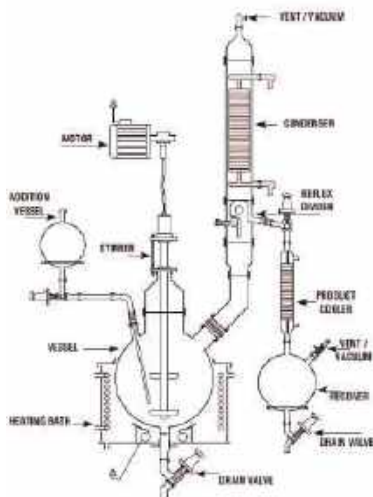

The units are available in vessel sizes of 20, 50, 100, 200, 300 & 500L and is suitable for operation under atmospheric pressure and full vacuum.

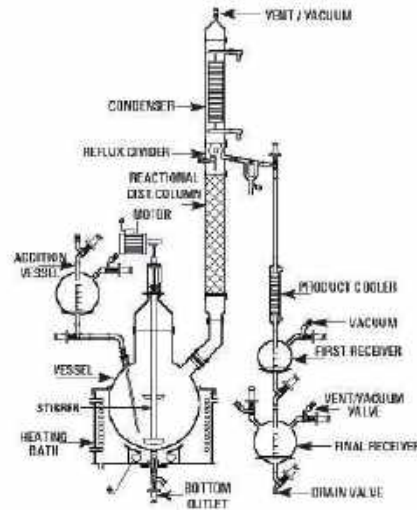
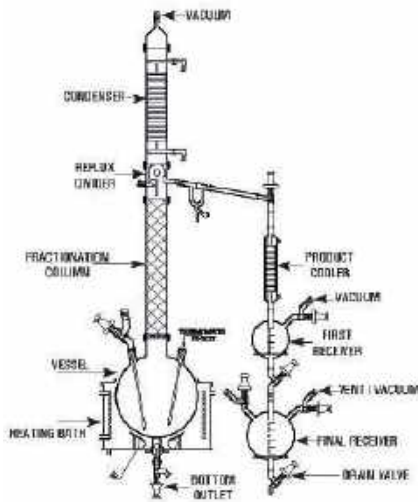

Liquid Liquid Extraction Unit 20L to 300L

Solid Liquid Extraction Unit 20L to 300L

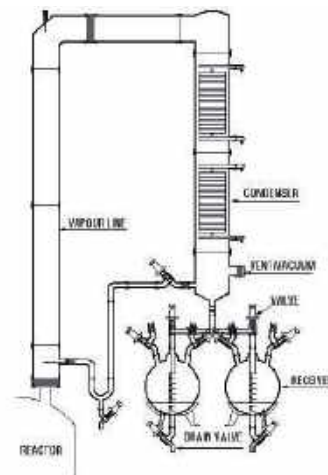
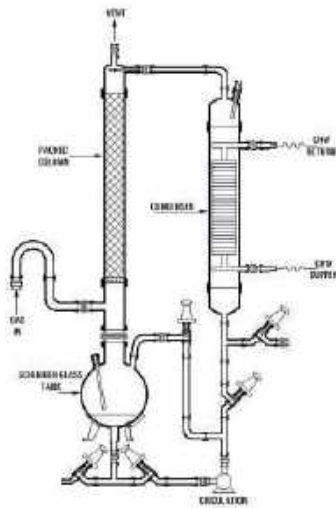
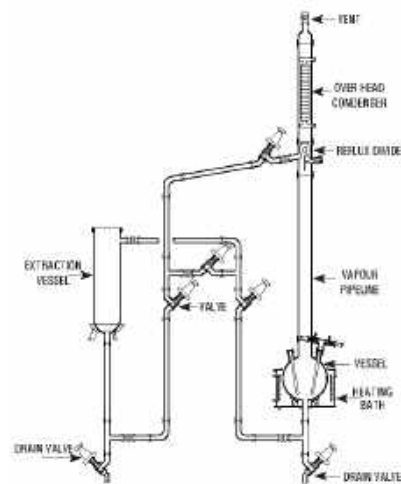
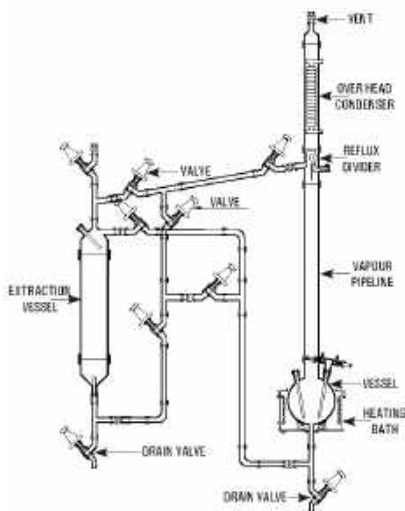

Essential Oil Distillers 10L to 200L

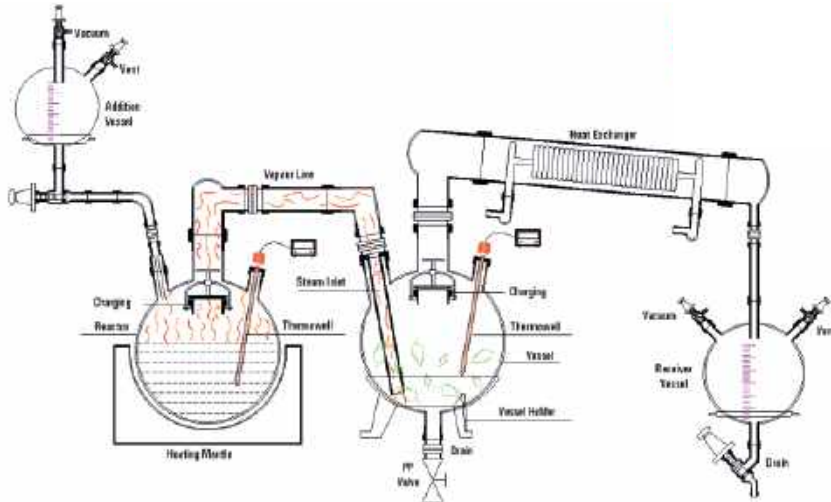

Multi Purpose Unit 20L to 300L

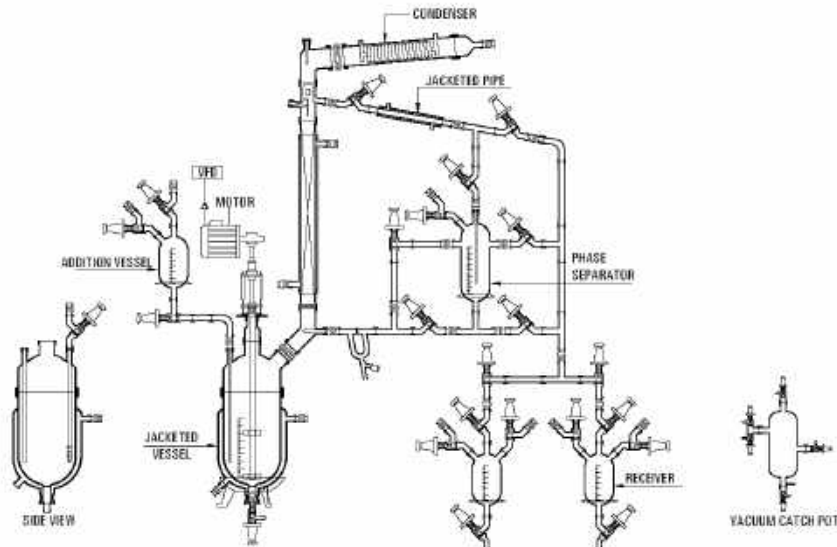

HCL Adiabatic Absorption

Jacketed Mixing Reactor upto 300L

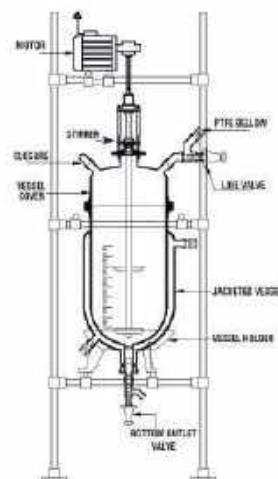
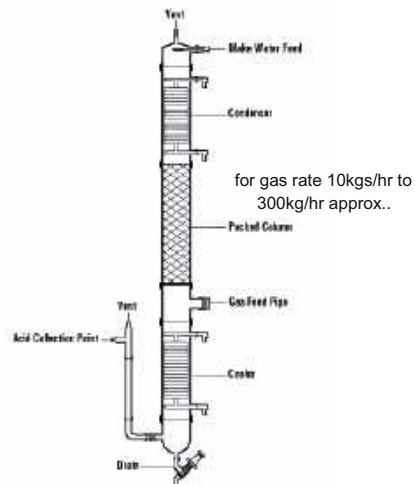

High Pressure Glass Reactor (0.5Ltr to 10 Ltr)

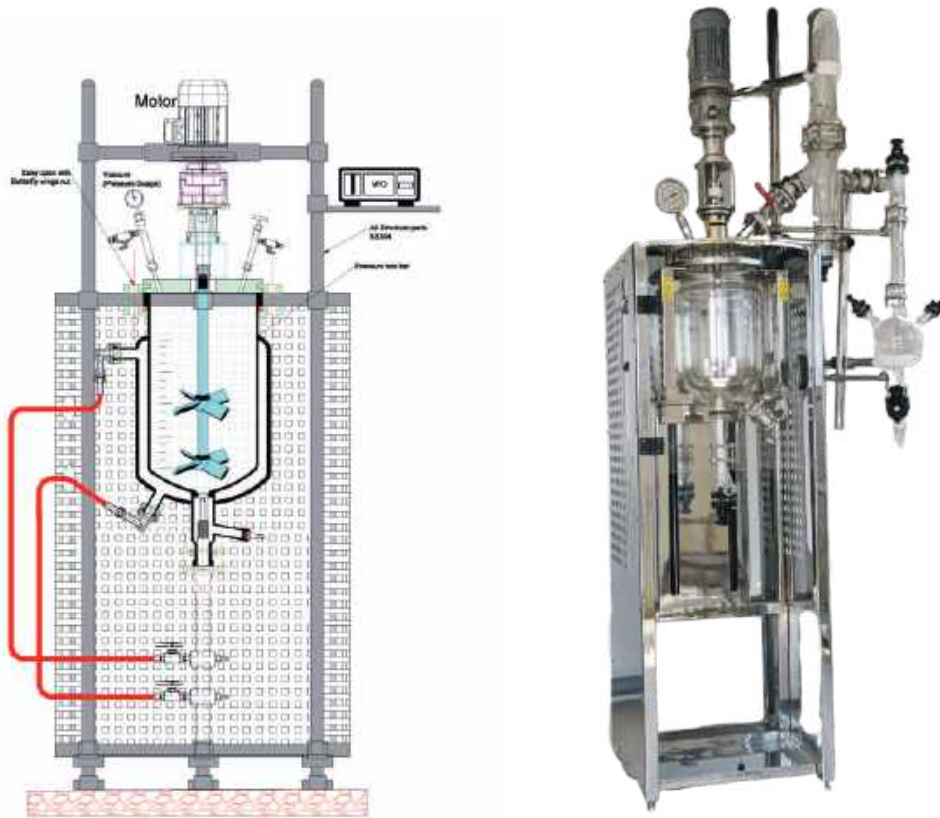

Operating Jacket Pressure Up to +0.5 barG (0.05 MPa)

*Automation on Request

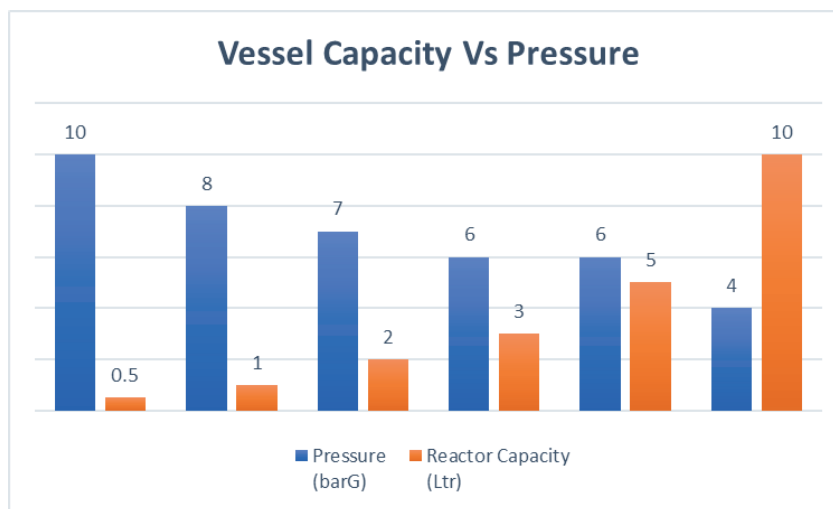

A high-pressure glass reactor is a specialized vessel designed for chemical reactions under elevated pressure, achieved by the reaction itself or externally supplied sources like hydrogen. Operating at temperatures above solvent boiling points, these reactors impact reaction dynamics by increasing concentration and collision frequency among molecules, accelerating reactions.

Agitated Glass Nutsche Filter/ Peptide Synthesizer 10L to 300L



Rotary Evaporator 5L to 100L



Jumbo Rotary Evaporator 200L to 800L



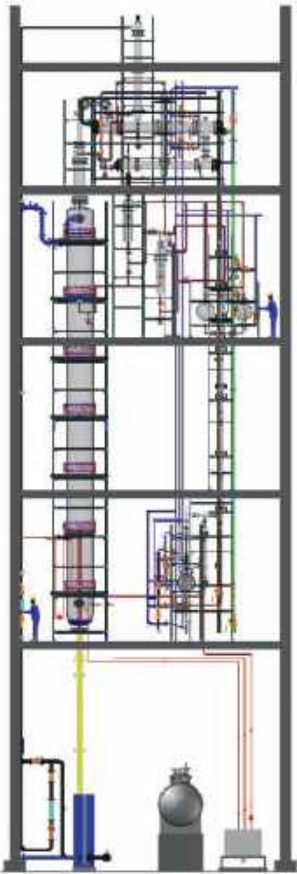

BROMINE RECOVERY UNIT

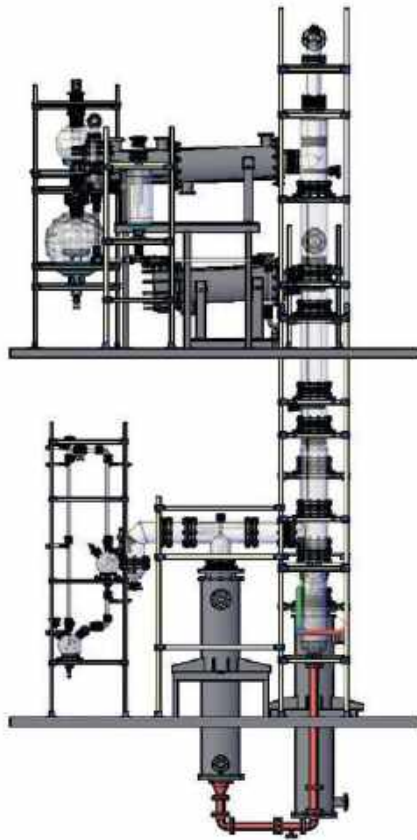

HCL GAS GENERATOR

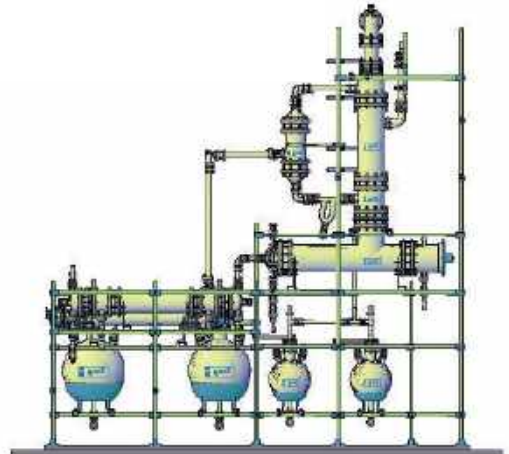

SULFURIC ACID CONCENTRATION SYSTEM

- | | |
|--|-------------------------------------|
| 1. Absorption systems for gases such as HCl, Cl ₂ , SO ₂ , HBr, NH ₃ , Br ₂ , NO _x etc | 8. Solvent Recovery |
| 2. Anhydrous HCl Gas Generation Unit by different routes viz.
- Sulphuric Acid
- Boiling Route
- Calcium Chloride Route
- Cyclic Route | 9. Iodine Recovery |
| 3. HBr Gas Generator (By Boiling Route) | 10. Raw DCB Plant |
| 4. Sulphuric Acid Dilution Units | 11. Falling Film Evaporator |
| 5. Hypochlorite Manufacturing Units | 12. Wiping Film Evaporator |
| 6. MCA Condensation Assembly | 13. Bromine Recovery System |
| 7. Distillation - Conversion of Batch Process to continuous Process | 14. Rotating Disk Extraction Column |
| | 15. Precision Metals Refining |
| | 16. Nitric Acid Purification System |
| | 17. HCL Purification System |





A BOROSIL SCIENTIFIC Company

Custom Glassware

Besides the manufacturing of our standard glass components, we specialize in producing borosilicate glassware as per customer requirement.

For any components, which are not in our range of standard production, we can fabricate the same as per required drawing or sample. Our experienced glass blower team can assist drawing or sample.

Our experienced glass blower team can assist you in designing of any components as per client requirement.

As a part of our super speciality - The one of the Indigenous segment that is CUSTOMIZED GLASSWARE.



Please contact CT Enterprises for quotation.
Email: sales@ctenterprises.in | Phone: +91 8977721310

TECHNICAL INFORMATION

BOROSIL LOW EXPANSION BOROSILICATE GLASS:

From the 16th century to the present day, chemical research teams have been using glass containers for a very simple reason. As the glass container is transparent, the contents and the reaction are clearly visible. However, since chemists need to heat, cool and mix chemical substances, ordinary glass is not always appropriate for laboratory work.

Laboratory work requires apparatus made of glass that can readily be moulded into any desired shape or form. It requires glass that offers maximum inertness when in contact with the widest range of chemical substances. The glass should have the capability to withstand thermal shock without fracture, and it should facilitate high temperature work without deforming. It should be resilient enough to survive the everyday knocks to which it will be subjected in normal laboratory handling, washing and sterilising processes.

BOROSIL is the trade name of such a glass.

The products represent optimum mechanical, thermal and chemical behaviour. This glass is used in laboratories as well as for industrial applications, where thermal shock resistance, mechanical resistance as well as unusual chemical resistance are required.

CHEMICAL COMPOSITION OF GLASS

Borosil glass is a 3.3 Type I low alkali borosilicate glass. It is virtually free from the Magnesia-Lime-Zinc group, and is also completely free of arsenic and other heavy metals. Its **typical chemical composition** is given below.

Content	Approx % by weight
SiO ₂	81
B ₂ O ₃	13
Na ₂ O / K ₂ O	4
Al ₂ O ₃	2

THERMAL PROPERTIES

Borosil glass has a low co-efficient of thermal expansion. Consequently, the thermal stresses under a given temperature gradient are also low. The glass can withstand

higher temperature gradients and also sudden temperature changes / thermal shocks. Minute scratching of the glass surface can, however, reduce its thermal resistance. 'Strain Point' should be regarded as the maximum safe operating temperature for Borosil glassware. When heated above 500°C, the glass may acquire permanent stresses on cooling.

All Borosil laboratoryware is annealed in a modern Lehr, under strictly controlled conditions to ensure minimal residual stresses in the products.

The **typical thermal properties** of Borosil glassware are mentioned below

Coefficient of Linear Expansion	3.3 x 10 ⁻⁷ cm / °C
Strain Point	515°C
Annealing Point	565°C
Softening Point	820°C
Specific Heat	0.2
Thermal Conductivity (Cal / cm ³ / °C / sec)	0.0027

CHEMICAL PROPERTIES

BOROSIL 3.3 Glass is highly resistant to water, neutral and acid solutions, concentrated acids and acid mixtures, and to chlorine, bromine, iodine and organic substances. The chemical resistance of this glass is superior to that of most metals and other materials, even when exposed to long processing periods and temperatures above 100 °C. A slight release of mainly monovalent ions takes place after exposure of the glass to water or acids. A very thin layer of impervious silica gel is subsequently formed on the surface of the glass, which in turn slows down further attack. At higher temperatures and in more concentrated forms the glass surface is subject to increased attack by hydrofluoric acid, hot phosphoric acid and alkaline solutions.

Hydrolytic Class (ISO 719)	HGB 1
Acid Class (DIN 12 116)	S1
Alkali Class (ISO 695)	A 2

A GUIDE ON GLASS BREAKAGE AND RECOMMENDED SOLUTIONS

Type of breakage	Causes of glass breakage	Solution	
Breakage during heating procedures	Drying up of vessel during heating due to evaporation	Do not leave the vessel unattended during heating procedure	
	Use of excessive heat throughout the experiment	Decrease the temperature as the liquid level drops	
	Use of point source heating	Solution	
		Use a large but soft flame for heating	
	Heating of the vessel above the liquid level	"Ensure that the flame is in contact with the vessel below the liquid level"	
Uneven heating the vessel over electric heaters and hot plates; use of an under sized hot plate	"Always ensure that the surface of the hot plate is larger in area than the base of the vessel being heated."		

A GUIDE ON GLASS BREAKAGE AND RECOMMENDED SOLUTIONS

Type of breakage	Causes of glass breakage	Solution
Breakage during cooling procedures	Placing the hot vessel on cold surface/ filling up a hot vessel with cold liquids	Allow the vessel to cool before placing or filling it up on/ with cold surfaces/substances
Breakage due to scratches and abrasions inside the vessel	Use of incorrect anti-bumping device, such as broken porcelain with sharp edges that causes internal abrasions and reduces mechanical strength of the glass	Always use anti-bumping devices in the vessel, such as powdered pumice or glass wool
	Use of improper stirring device that causes internal abrasions and reduces mechanical strength of the glass	Always use a teflon sleeve or a similar device on stirring rods, to prevent scratching of the inside of the vessel When using a glass vessel with a magnetic stirrer, always use a covered follower. This prevents abrasion of the walls from inside of the vessel
Breakage of the base of the glass container	Placing the hot vessel on cold surface/ filling up a hot vessel with cold liquids	Allow the vessel to cool before placing or filling it up on/ with cold surfaces/substances
	Use of a glass or metal mechanical stirrer in a glass vessel	Always pre-determine the height of the stirrer before use, to ensure that the stirrer blade does not come in contact with the base or sides of the vessel
	Addition of the antibumping device from a height in the glass vessel	
Breakage due to vacuum/ pressure	Addition of water to acid in a glass vessel which generates sudden heat and leads to breakage	Always ensure to add water first in the glass container followed by slow addition of acid
	Application of sudden pressure changes	Apply and release positive or negative pressures gradually.
Breakage due to vacuum/ pressure	Use of pressure beyond the limit	Refer manufacturers instructions carefully before applying pressure/ vacuum to the glass vessel
	Breakage of stopcocks and joints	Stopcocks stuck hardly on burettes and funnels
Mechanical separation of the joint by carefully rocking the Cone in the socket, or gentle tapping the socket flange on a wooden surface, or by heating the socket and not the Cone in a localised flame		
Use of penetrating oil		
Frequent lubrication to prevent the stopcock and joints from sticking		
When using lubricants, it is advisable to apply a light coat of grease all around the upper part of the joint. Use only a small amount, and avoid greasing the part of the joint that comes in contact with the inside of the apparatus. Three types of lubricants are commonly used on standard taper joints. (a) Hydrocarbon grease is the most widely used. It can be removed easily by most laboratory solvents, including acetone. (b) As hydrocarbon grease is easy to remove, silicon grease is usually preferred for higher temperature or high vacuum applications. It can be removed with chloroform easily. (c) For long-term reflux or extraction reactions, a watersoluble, organic and insoluble grease such as glycerin, is suitable. Glycerin can be removed by means of water		
Breakage during inserting glass tubing into rubber bung	Improper lubrication	Use water, oil or glycerol on both, the tubing as well as the rubber bung
	Presence of rough ends	Always fire-polish the rough ends of the glass tubing before attempting to insert it into flexible tubing

CLEANING OF GLASSWARE

Use of clean glassware is crucial for efficacy and efficiency of chemical reactions or biological processes. It is the key to success of any experiment. Use of dirty glass ware can lead to cross contamination of chemicals thereby leading to erroneous results. Cleaning of glassware should be an integral part of the good laboratory practices and should be followed by each member of the lab after each use.

DID YOU KNOW ?

New glassware is slightly alkaline in reaction. Hence, it should be soaked for about 2 to 3 hours in acidic water (1% solution of hydrochloric acid or nitric acid). Rinse with water and then soak the empty glassware in a basin / tub containing suitable cleaning agent / solution for 20 to 30 minutes.



Cleaning agents :

- Water/Purified water/warm water – Routine cleaning of all glassware
- Soaps/ detergent solution - Routine cleaning of all glassware
- Cleaning powders with/without abrasives – For exceptionally dirty glassware
- Acetone/Solvents - Glassware with greasy, sticky, waxy materials and glassware containing water immiscible solvents
- Hot nitric acid – glassware containing cloudy precipitates and coagulated organic matter, glassware required for TOC analysis

NOTE : After use of any of the cleaning agents, other than water, glassware should be rinsed and cleaned with water as per the standard laboratory procedure

DO'S AND DON'TS OF CLEANING

DO'S	DON'T'S
Remove the content of glassware before washing	Do not use a metallic scrubber or a brush with metallic bristles for cleaning
Remove all markings / sticker labels from the glassware.	Do not use strong alkalis for cleaning
Bring glassware to ambient temperature before cleaning, if they are subjected to heating or cooling during analysis	Do not use chromic acid and sulphuric acid mixture for cleaning as it is hazardous and toxic in nature
Use a suitable cleaning agent depending upon the type of dirt	
Soak the glassware in the cleaning agent for about half an hour before cleaning	
Use a good quality brush for cleaning	
After applying the cleaning agents always rinse the glassware first with tap water and finally with purified water	
Recommended temperature for drying of glassware is 60°C - 100°C	

Please contact CT Enterprises for quotation.

Email: sales@ctenterprises.in | Phone: +91 8977721310

Pipette Cleaning

- Dip the pipettes with their tips down, in a cylinder or tall jar of water, immediately after use.
- Do not drop them into the jar as this may break or chip the tips and render them useless.
- A pad of cotton or glass wool at the base of the jar will help to prevent breaking of the tips.
- Please ensure that the water level is high enough to immerse the greater portion of all or each of the Pipettes.
- Then drain the Pipettes and transfer them into a cylinder or jar containing any suitable cleaning agent or any suitable detergent solution.
- Allow it to soak in a jar or cylinder for about half an hour.
- Drain the pipette and run tap water over and through them until all contents are removed.
- Soak the Pipettes in purified water for at least one hour.
- Remove them and dry the external surface with a cloth, shake out the water and dry in oven.
- After drying, place the Pipettes in a dust-free drawer.
- For sterile applications, wrap serological and bacteriological Pipettes in an autoclavable bag and autoclave at 121°C for 30 mins or place them in Pipette cans and sterilise them in the dry air steriliser at 160°C for two hours.
- A Pipette used for transferring infectious material should have a plug of cotton placed in its mouth end before sterilising

Burette Cleaning

- Remove stopcock key before cleaning and wash the stopcock key separately
- Wash the burette with suitable cleaning agent or any other suitable detergent solution
- Rinse with tap water until all the dirt is removed. Then rinse with purified water.
- Keep the cleaned burette in inverted position until dry.
- Open the stopcock and keep for drying.
- Before the stopcock key is replaced in the burette, lubricate the joint with a small amount of lubricant.
- Always cover tip of burettes with butter paper or aluminium foil, when not in use.

Note: **The burette stopcock keys and glass stopcocks are not interchangeable**, hence, glass key and burette bore should be marked properly to avoid mix-ups

Culture Tubes

- Culture tubes which have been used previously must be sterilized before cleaning. The best general method for sterilising culture tubes is by autoclaving for 30 minutes at 121°C (15 lb pressure). Media which solidify on cooling should be poured out while the tubes are hot.
- After the tubes are emptied, brush them with a suitable cleaning agent.
- Rinse thoroughly with tap water, rinse with purified water, shake out the water and dry in oven.
- After cleaning before the next use, the culture tubes need to be sterilized again.
- The culture tubes and culture medium can be sterilized together in one cycle or can be sterilized separately.
- In the latter case, the sterile medium can be filled in the sterile culture tubes aseptically.

Serological Tubes

- Serological Tubes should be chemically clean but need not be sterile. However, specimens of blood which are to be kept for some time at room temperature should be collected in a sterile container. It may be expedient to sterilize all tubes as routine.
- To clean and sterilize tubes containing blood, discard the clots in a waste container and place the tubes in a large basket.
- Put the basket with others, in a large bucket or boiler. Cover with water, add a fair quantity of soft soap or suitable cleaning agent and boil for 30 minutes. Rinse the tubes and clean with brush, rinse and dry with the usual precautions.

Note: It is imperative when washing serological glassware that all acid, alkali and detergent be completely removed. Both acid and alkali in small amounts destroy complement and in larger amounts produce haemolysis. Detergents interfere with serologic reactions.

Serological tubes and glassware should be kept separate from all other glassware and used for nothing except serologic procedures.

Microscope Slides

Cleaning of New slides

- Put a drop of cleaning solution of the slide. This can be a detergent solution or diluted alcohol solution
- Apply the cleaning solution uniformly on both the sides of slide and clean the surface carefully with your fingers or using a lint-free microfibre towel
- Rinse thoroughly under running tap water until the cleaning solution is completely washed out
- Ideally a thoroughly cleaned slide should hold a layer of water uniformly over its surface. This indicates that the slide is cleaned properly. If the water layer is formed over the surface in blotches, repeat the cleaning
- After cleaning is done dry slide using a paper towel/ microfibre towel.
- Allow the slides to air dry for some time before using

Cleaning Used slides

- Place the used slide in a container full of warm water and detergent
- Leave the slide in this for at least 0-8 hours
- Clean the slide using a gauze by rubbing both the sides until they are free of the dirt, stains, oil, etc.
- Rinse thoroughly under running tap water until the cleaning solution is completely washed out
- Ideally a thoroughly cleaned slide should hold a layer of water uniformly over its surface. This indicates that the slide is cleaned properly. If the water layer is formed over the surface in blotches, repeat the cleaning
- After cleaning is done dry slide using a paper towel/ microfibre towel
- Allow the slides to air dry for some time before using

Recalibration of volumetric glassware

Abstract: ASTM Standard E 452-01, Clause 4.2

3.3 low expansion borosilicate volumetric glassware will hold its calibration indefinitely provided that it is not exposed to hydrofluoric acid, phosphoric acid, or strong, hot alkalis, and that it is not heated above 150°C when dry. A frosting of the glass surface (when viewed dry) indicates that chemical attack has occurred and recalibration may be in order. As a precaution, however, it is recommended that the glassware be recalibrated after 10 years of service regardless of its appearance.

AUTOCLAVING OF GLASSWARE

Autoclaves are widely used to sterilise instruments, glassware and plasticware, solutions and media, and to decontaminate biological wastes. Due to the physical hazards (e.g. heat, steam and pressure) associated with autoclaving, extra care must be taken to use them safely. Each autoclave has unique characteristics and operating requirements. Please review and understand the owner's manual before using any autoclave for the first time, and every time thereafter. Also, please follow all the safety regulations for autoclaving, laid down by your institution.

Autoclaving empty glassware

1. Place individual glassware vessels within a heat resistant plastic or metal tray on a shelf or rack.
2. Never place them directly on the autoclave base or floor
3. Always maintain space (>5 cm) between glass vessels to give them room to expand while heating, and to prevent them from hitting other vessels when entering or leaving the autoclave
4. Add water rising up to 1/4 to 1/2 inch in the tray, so that the glassware will heat more evenly
5. Large heavy glassware, such as 3L or larger spinner flasks 5L or larger bottles and carboys should have a small amount of distilled water placed inside them to help generate steam when they are being sterilised dry in an autoclave

Autoclaving glassware containing liquids

Never autoclave items containing corrosives (e.g. acids, bases, phenol), solvents or volatiles (e.g. ethanol, methanol, chloroform) or radioactive materials.

1. Fill the glassware only half full with the liquids to be sterilised.
2. Take into consideration, the volume of liquid to be autoclaved.
For e.g. : 2-litre flask containing 1 litre of liquid takes much longer to sterilise than four 500 ml flasks, each containing 250 ml of liquid
3. Do a test run when autoclaving larger volumes of liquid, to make sure that the liquid has reached 121°C
4. Always use the slow exhaust or liquid cool cycle when autoclaving liquids, to prevent the liquid from boiling over, causing loss of the contents
5. Suspend an autoclave thermometer with a thin wire, in the middle of the liquid-filled container to record the highest temperature reached. Then, check its reading after the autoclave run is complete. If the temperature is too low, then the run-time will need to be increased or the volume will need to be reduce
6. To prevent bottles from getting shattered during pressurisation, the caps of the vessels with liquids must be loosened completely before loading

Safety during Autoclaving

Always follow the safety precautions to protect yourself and the equipment being used.



1. Be sure to wear the correct PPE including a lab coat, eye protection, closed-toe shoes, and heat-resistant gloves
2. Remember that after usage, glassware will be hot and can cause serious injury if the correct precautionary measures aren't taken
3. Always wait for the pressure gauge to drop to zero with zero time remaining before you open the door
4. Stand behind the door as you open it and allow all the steam to fully escape before reaching into the autoclave
5. Let glassware fully cool before touching them

DO'S	DON'T'S
Wait for 5 minutes before removing dry glassware from the autoclave, and wait for 10 to 20 minutes before removing glassware containing liquids	Do not tighten caps on the vessels immediately after autoclaving The cap or the vessel may get shattered due to the vacuum resulting from the cooling of the steam in the vessel
For non-liquid loads, please allow the glassware to cool for 15 minutes before touching it For liquid loads, please allow the liquid to stand for a full hour before touching the glassware	Do not put hot glassware, especially large bottles, from an autoclave (or any other heat source) on to a cold bench top. The stress that is induced will often cause the base of the vessel to crack or fall off, releasing its hot contents

Please contact CT Enterprises for quotation.

Email: sales@ctenterprises.in | Phone: +91 8977721310

PERSONAL SAFETY

- Use tongs or asbestos gloves to remove any glassware from heat. Hot glass can cause severe burns.
- Protective gloves, safety shoes, aprons and goggles should be worn to safeguard against chemical accidents, spilling or splattering.
- Always flush the outside of the acid bottle with water before opening it. Do not place the stopper on the counter top, where someone else may come in contact with acid residue.
- Care should be taken when handling mercury. Even a miniscule amount of mercury in the base of a drawer can poison the atmosphere in an entire room. Mercury toxicity is cumulative and the element's ability to amalgamate with a number of metals is well known. Following any accident involving mercury, the area should be checked thoroughly to ensure that there are no globules remaining. All mercury containers should be kept well stoppered.
- Never drink from a beaker. A beaker intended specifically for the use of drinking is a hazard in the laboratory. Do not taste chemicals to identify them. Smell chemicals only when necessary, and only by wafting a small amount of vapour towards the nose.
- Avoid using a Pipette with the mouth, particularly when using concentrated acids, alkalis or potentially biohazardous materials. Use mechanical means, such as a rubber bulb or an automatic dispenser.
- Do not fill the receptacle with any material other than that mentioned on the label. Label all containers before filling. Discard the contents of any unlabelled containers.
- To prevent breakage when clamping glassware, do not permit glass-to-metal contact, and do not use excessive force to tighten the clamps.
- Do not look down into a Test Tube being heated or containing chemicals, and do not point its open end at another person. A reaction could cause the contents to be ejected suddenly, resulting in injury.
- Splattering from acids, caustic materials and strong oxidising solutions on the skin or clothing should be washed off immediately with large quantities of water.
- When working with chlorine, hydrogen sulphide, carbon monoxide, hydrogen cyanide and other highly toxic substances, always use a protective mask. Alternatively, perform these experiments under a fume hood in a well ventilated area.
- In working with volatile materials, please keep in mind that heat causes expansion and confinement of such expansion results in explosion. Also remember that this danger exists even if external heat is not applied.
- Perchloric acid is particularly dangerous as it explodes when brought in contact with organic materials. Do not use perchloric acid around wooden benches or tables.
- Keep perchloric acid bottles on glass or ceramic trays with capacity that is adequate to hold all the acid in case the bottle breaks.
- When using perchloric acid, always wear protective clothing.
- When using hot plates and other electrical equipment, always ensure that the wire and plugs are in good condition. Do not handle an electrical connection with damp hands

A

APPARATUS

	Cat No.	Page No.
Arsenic determination apparatus As per USP	5200	121
Arsenic determination apparatus GUTZEIT	5201	121
Arsenic determination apparatus as per BP	5202	121
Arsenic determination apparatus as per IP	5203	122
Arsenic determination apparatus GUTZEIT as per IS	5204	122
Arsenic determination apparatus as per JP	5205	122
Arsenic determination apparatus as per EP	5206	123
Oxygen combustion as per USP	5210	123
Methoxy Determination Assembly	5211	123
Sulphur Di-oxide assembly as per USP	5212	124
Sodium Alginate Assembly as per USP	5215	124
Sodium Bicarbonate Assembly	5216	124
Lung Nitrometer	5217	124
Carbonate Assembly	5218	125
Gas washing apparatus	5219	125
R M Value Apparatus	3454	87
Eathanol Distillaiton Gas Assembly	3455	87
Dean Stark Distilling Apparatus	3602	88
Gas generator apparatus, KIPPS	6550	161

ADAPTERS

Adapters, Enlarging, Connecting	8800	181
Adapters, Reduction, Connecting	8820	181
Vaccum Connection	8830	181
Multiple Adapter	8831	182
Adapters, Multiple With Two Necks - one vertical & one at 45°	8832	182
Adapters, Multiple with three Neck, Two Parallel & one at 45°	8833	182
Adapters, Swan Neck	8834	183
Adapter Cone / Rubber tubing	8835	183
Adapters, Cone/ Flexible Tubing	8836	183
Adapters, Receiver, Straight with Vacuum	8838	184
Adapters, Receiver, Bent with vent	8839	184
Adapter cones screw thread	8840	185
Slopping Plane still head	8841	185
Adapter receiver	8844	185
Adapter receiver, Plain bent	8845	186
Adapter recovery Bent with slopping end	8846	186
Adapter recovery Bent vertical	8847	186
Claisen head slopping	8849	187
Adapter receiver plain, vertical	8850	187
Splash Head	8851	187
Splash head slopping pear shape	8852	188
Steam distillation heads	8853	188
Adapter straight cone with stopcock	8854	188
Adapter straight socket with stopcock	8855	189
Adapter bend cone with stopcock	8856	189
Adapter bend socket with stopcock	8857	189
Thermometer Pocket Long Type	8861	190
Thermometer Pocket Short Type	8862	190

B

BEAKERS

Beaker, Low form with spout	1000	27
Beaker, Tall form without spout	1040	27
Beaker, Tall form with spout	1060	28
Beaker, Phillips (Conical) with spout	1080	28

BOTTLES

	Cat No.	Page No.
Aspirator Bottles with GL 45 Cap and Tubulation	1220	31
Aspirator Bottles with GL 45 cap and socket	1240	31
Aspirator Bottles with GL 45 cap and I/C stopcock	1245	32
B.O.D. Bottles	1250	32
Roux Bottles	1290	32
Bottles, Reagent, narrow mouth, with I/C stopper	1500	33
Bottles, Reagent, narrow mouth, with screw cap	1501	33
Screw caps with pouring rings	1503	36
High temperature resistant screw caps	1505	36
Multiport HPLC Cap`	1513	36
Bottles, Reagent, wide mouth, Square	1506	37
Reagent Bottles	1507	37
Bottles, Reagent, narrow mouth, with I/C stopper, Amber	1509	38
Bottles, Reagent, narrow mouth, with screw cap, Amber	1519	38
Solution Bottles	1585	39
Bottles, tooled neck, Solution bottle	1589	39
Bottle, relative density, with capillary, With Certificate	1624	40
Bottle, relative density, with capillary	1625	40
Bottle, Pyknometer, with thermometer and capillary side tube	1627	40
Bottles, weighing, with interchangeable lids	1630	41
Bottles, weighing, with interchangeable Amber	1631	41
Bottles, dropping with dropper and rubber teat	1640	41
Bottles dropping with pipette and rubber teat, Amber	1650	42
Bottles, wash, set with interchangeable stopper	1660	42
Bottles, stopper for wash bottles cat no. 1660	1661	42
Bottles, flasks for wash bottles cat no. 1660	1662	43
Bottles, wash, LDPE plastic bottles	166P	43
Bottles, plastic clamp for joint fittings	1665	43
Bottles, for gas washing	1760	44
Stopper for gas washing bottle, cat no. 1760	1761	44
Bottles, for gas washing bottle, cat no. 1760	1762	44
Gas sampling tubes	1764	45
Impinger	1765	45

BURETTES

Burettes with Boroflo stopcock, Class A	2121	48
Burettes with Boroflo stopcock, Class B	2122	48
Burettes With Glass stopcock, Class A	2123	49
Burettes With Glass stopcock, Class B	2124	49
Burettes With PTFE stopcock, Class A	2129	50
Burettes With PTFE stopcock, Class A	2130	50
Burettes with Boroflo stopcock, Class A, Amber	2131	51
Burettes with Boroflo stopcock, Class B, Amber	2132	51
Autoburettes with Glass stopcock, Class A	2149	52
Autoburettes with Glass stopcock, Class B	2150	52
Autoburettes with Glass stopcock, Class A, Amber	2149A	53
Autoburettes with Glass stopcock, Class B Amber	2150A	53
Autoburettes with PTFE stopcock, Class A	2153	54
Autoburettes with PTFE stopcock, Class B	2154	54

	Cat No.	Page No.		Cat No.	Page No.
BURETTES			DESICCATORS		
Autoburettes with PTFE stopcock, Class A, Amber	2153A	55	Desiccators with Cover and Porcelain Plate, Plastic Knob	3082	78
Autoburettes with Glass stopcock, Class A, Amber	2154A	55	Desiccators with Vacuum, Stopcock with PTFE Spindle, and Porcelain Plate	3083	78
Autoburettes with Boroflo stopcock, Class A	2155	56	Desiccators with Cover and Porcelain Plate, Plastic Knob, Amber	3084	79
Autoburettes with Boroflo stopcock, Class B	2156	56	Desiccators with Vacuum stopcock with PTFE spindle and Porcelain plate, Amber	3085	79
Autoburettes with Boroflo stopcock, Class A, Amber	2155A	57			
Autoburettes with Boroflo stopcock, Class B, Amber	2156A	57			
C			DISHES		
CONES			Dishes, Crystallizing	3140	81
Cones, Imhoff, Sediment, Sharp Tip	2160	61	Dishes, Culture, Petri	3160	81
Cones, Imhoff, Sediment, Blunt Tip	2180	61	Dishes, Culture Petri, Borosil S-Line	3165	81
Cones, Imhoff, Sediment, Sharp Tip	6560	160	Trays, Drying Heavy Wall	3170	82
Cones, Imhoff, Sediment, Sharp Tip	6561	160	Dishes, Evaporating, Flat Bottom, With Pour Out	3180	82
CONDENSERS			DISTILLING APPARATUS		
Condensers, Liebig, with sealed Inner Tube	2340	63	Graham Condenser, I/C Joints	3340	85
Condensers, Liebig, Drip Tip	2400	63	Graham Condenser, I/C Joints and Stopper	3360	85
Condensers, Allihn, Drip Tip	2480	63	Friedrichs Condenser I/C joint and stopper Friedrichs	3380	85
Condensers, Graham, Coiled Drip Tip	2560	64	Condenser, Compact, I/C joint and stopper	3440	86
Condensers, Friedrichs, Drip Tip	2640	64	Essential Oil Determination Apparatus (Clevenger Apparatus, as per IS 1797 Essential Oil)	3450	86
Condensers, Double surface	2641	64	Determination Apparatus (Clevenger Apparatus)	3451	86
CHROMATOGRAPHY COLUMNS			Alcohol Distillation Unit	3452	87
Chromatography Column, Plain With Glass Stopcock	6100	151	R M Value Apparatus	3454	87
Chromatography Column, Plain With Sintered Disc and Glass Stopcock	6101	151	Eathanol Distillation Glass Assembly	3455	87
CYLINDERS			Dean Stark Distilling Apparatus	3602	88
Nessler Cylinders	2975	68	E		
Cylinders Class A, Hexagonal Base, with I/C Stopper	2981	68	EXTRACTORS		
Cylinders Class B, Hexagonal Base, with I/C Stopper	2982	69	Soxhlet for extraction with I/C joint Condensers,	3740	98
Cylinders USP, Class A, Hexagonal Base, with I/C Stopper	2983	69	Allihn, for soxhlet extraction apparatus	3741	98
Cylinders Class A, Hexagonal base, Pour out	3021	70	Soxhlet extraction apparatus set	3840	99
Cylinders Class B, Hexagonal base, Pour out	3022	70	F		
Cylinders ASTM Class A, Hexagonal base, Pour out	3026	71	FLASKS		
Cylinders ASTM Class B, Hexagonal base, Pour out	3027	71	Flask, Flat bottom, narrow mouth	4060	103
Cylinders, Tapped Density Cylinder As Per USP, Ch. 616, set of two	3032	72	Flask, Flat bottom, narrow mouth, short neck with I/C joint	4100	103
Cylinders, Tapped Density Cylinder As Per USP#68 Ch. 616, 100ml	3033	72	Flask, Round bottom, narrow mouth	4260	104
Cylinders, Tapped Density Cylinder As Per USP, Ch. 616, 250ml	3034	72	Dissolution E- Flask, USP, Clear	4265	105
Rain Measure Cylinder	3070	72	Dissolution E- Flask, USP, Amber	4267	105
Crow Cylinder	3041	73	Dissolution D- Flask	4270	105
			Flask Pear Shape with I/C joint	4315	106
			Flask Rotary Evaporator with I/C joint	4320	106
			Flask Reaction vessel	4330	106
			Lid for Reaction vessel flask	4331	107
			Flask, Round bottom, narrow mouth short neck with I/C joint	4380	107
			Flask, Round bottom, 2 necks, angular	4381	108
			Flask, Round bottom, 2 necks, parallel	4382	109

	Cat No.	Page No.		Cat No.	Page No.
Flask, Round bottom, 3 necks, angular	4383	110	Powder Funnel, Stem, with cone	6230	157
Flask, Round bottom, 3 necks, parallel	4384	111	Separating, Globe Shape, with Stopcock and I/C Stopper	6340	158
Flask, Round bottom, 4 necks, angular	4385	112	Separating, Pear Shape, with Stopcock and I/C Stopper	6400	158
Flask, Round bottom, 4 necks, parallel	4386	113	Separating, Pear Shape, with Boroflo Stopcock and I/C Stopper	6402	158
Flask, Culture, Haffkine	4422	113	Separating, Pear Shape, with PTFE Stopcock and I/C Stopper	6403	159
Flask, Distilling with side arm	4620	114	Pressure equilising cylindrical with PTFE stopcock	6405	159
Flask, Distilling with I/C stopper	4621	114	Dropping funnel	6408	159
Flask, Conical Erlenmeyer, Narrow Mouth with Rim	4980	114			
Flask, Conical Erlenmeyer, Long Neck without Rim	4981	115			
Flask, Conical Erlenmeyer, without Rim	4982	115			
Flask, Conical Erlenmeyer, Narrow Mouth	4989	115			
Flask, Conical Erlenmeyer, Narrow Mouth with Tilt measure	5000	116			
Flask, Conical Erlenmeyer, Narrow Mouth with I/C Joint and Stopper, Amber	5019	116			
Flask, Conical Erlenmeyer, Narrow Mouth with I/C Joint and Stopper	5020	117			
Flask, Conical Erlenmeyer, with screw cap	5021	117			
Flask Conical Erlenmeyer, with screw cap, Baffled bottom	5025	117			
Flask, Conical Erlenmeyer, Wide mouth Filter	5100	118			
Flask with glass tubulation	5340	118			
Flask Iodine flask with I/C glass stopper	5400	118			
Kjeldahl Flask	5420	119			
Kjeldahl Flask with I/C Joint	5430	119			

FILTRATION PRODUCTS

Glass Filtration Assembly, 47mm	5350	129
Glass Filtration Assembly, 90mm	5350	129
Glass Filtration Assembly, With silicone stopper, 47mm	5360	130
Glass Filtration Assembly, With silicone stopper, 25mm	5370	131
Glass Filtration Assembly with bottle, 47mm	5380	132
Glass Filtration Assembly with bottle, 90mm	5380	132
Glass Filtration Assembly with GL 45 Universal adapter, 47 mm	5385	133
SS Filter Assembly with inbuilt clamp 47 mm	5330	135
SS Filter Assembly with external clamp 47 mm	5331	135
SS Filter Funnel with spin lock type, 47 mm	5332	136
SS Vacuum Filtration Manifold	5333	136
Vacuum Filtration Pump	5334	137
Filtration Assembly with inbuilt pump	5335	137
Filter membrane, Cellulose Nitrate	5147	139
Filter membrane, Gridded Cellulose Nitrate	5247	139
Filter membrane, Nylon-66	5347	139

Filter Papers

Qualitative Filter Papers	236-238
Ashless Quantitative	240-242
Hardened Ashless	244-245
Glass Fiber	246-247
Thimbles	248-249

FUNNELS

Filter Funnel, Glass, Short Stem	6140	157
Funnel test tube	6150	157
Powder Funnel	6220	157

H

HYDROMETERS

Range Finder Glass Hydrometers	3050	74
Twaddle Glass Hydrometers	3051	74
Specific Gravity Glass Hydrometers		
100 Divisions Range	3052	75
Baume Glass Hydrometers	3053	75
Alcoholmeters (Gay Lussac Hydrometers)	3054	75
Triple Scale Hydrometers	3055	76
Battery Hydrometers	3056	76
Brix Hydrometers	3057	76
Density Hydrometers	3058	77
Percentage Hydrometers	3059	77
Hydrometers For Every High Liquids	3060	77

K

KETTLES

Reaction Kettle Assembly	6947	163
Bottoms, only for Kettles Cat. No. 6947	6948	163
Covers, only for Kettles Cat. No. 6947	6949	163

L

LAB ACCESSORIES

Tongs for Beakers & Flasks	215
Tongs for Crucible	215
Clamps	215
Clamps with Bosshead	216
Universal Clamps	216
Burette Clamps	216
Bossheads	217
Retort Ring	217
Retort Base	217
Rod for Retort Base	217
Test Tube Stand	218
Test Tube Holder	218
Burners	218
Spatulas	219
Forceps Pointed	220
Forceps PTFE Pointed	220
Forceps Blunt Dissecting	220
Forceps PTFE Blunt	220
Wire Gauge	220
Triangular Tripod	220

	Cat No.	Page No.		Cat No.	Page No.
PREMIUM MICRO PIPETTE TIPS		339-342	SPREADER	9865	296
PROCESS SYSTEMS			SAMPLING AND STORAGE VIALS		
Block Reactor System		372-373	Amber	9914	198
Mini Bath Reactor		374-375	Clear	9913	198
Compact Lab Reactor		376-377	SINTERED WARE		
Bench Lab Reactor		378-379	Buchner Funnel With Sintered Disc	36060	202
Pilot Lab Reactor		380-381	Gooch Crucible Low Form, With Sintered Disc	32060	203
Radiance Batch Reactor		382-383	Tube for Gooch Crucible	32061	203
Radiance Flow Reactor		384-385	SILICA WARE		
Turnkey Projects		386	Silica Crucible	8900	210
Smart & Scalable Automation Reactor		387	Silica Crucible Lid only	8901	210
Reactor Accessories		389-397	Silica Basin with spout	8902	210
Reactor Utilities		398-399	Silica Volatile matter crucible plunger	8903	210
Q			SILICONE		
QUARTZWARE			Silicone cork / stopper		221
Quartz Beakers, low form with spout	1002	205	Silicone turnover flange septa for test tube, non serrated		221
Quartz Petri Dishes	3164	205	Silicone turnover flange septa for socket, non serrated		222
Quartz Muffle trays	3175	205	Silicone sleeve for crucible		222
Quartz Dishes / Basins round with spout	3185	206	Silicone filtration cone		222
Quartz Comustion Boat with handle	3186	206	Silicone pipette filler bulbs		222
Quartz Crucibles without lid	3190	206	Silicone teats		223
Quartz Lids for crucibles	3191	207	Silicone pipette filler, with valves		223
Quartz Volatile matter crucibles	3195, 3196, 3197	207	Silicone hand protectors		223
Quartz Silica triangles on Nichrome	3198	207	Silicone flask stand		223
Quartz Conical flasks	4984	207	Silicone sheet		223
Quartz Volumetric Flasks	5644	208	T		
Quartz Circular Capsule	8600	208	TUBES		
QUARTZWARE			Blood Sugar, Folin- Wu, Tube	7840	177
Quartz Reagent Bottle, with hollow stopper	1511	208	Tube Centrifuge, Plain	8060	177
Quartz Measuring cylinder w/spout class B,	3028	209	Tube Centrifuge, Graduated	8080	177
Quartz Funnel, 75mm	6141	209	Tube Centrifuge, Graduated with I/C Stopper	8084	178
Quartz Pipette measuring Mohr type,	7064	209	Tube Centrifuge, Graduated, PP Screw Cap	8090	178
Quartz Pipette, Transfer, Volumetric, Class B	7104	209	Tube Centrifuge, Heavy Duty, with Spout, Plain, Short conical bottom	8320	180
S			Tube Centrifuge, Heavy Duty, with Spout, Graduated, Short conical bottom	8340	180
STOPPERS			TUBES		
Stoppers, Glass, Penny head, ISO/DIN, Clear	8100	152,178	Tube for Culture collection	9801	192
Stoppers, Glass, Penny head, ASTM, Clear	8110	152,179	Tube, Culture, Round Bottom, Clear, with PP Cap	9900	197
Stoppers, Polypropylene (PP) Stoppers	8300	153,179	Tube, Culture, Round Bottom, Amber, with PP Cap	9901	197
Stoppers, Glass, Penny head, ISO/DIN, Amber	8400	153, 180	Tube, Culture, Flat Bottom, Clear, with PP Cap	9910	197
Stoppers, Glass, Penny head, ASTM, Amber	8410	153, 180	Tube, Culture, Flat Bottom, Amber, with PP Cap	9911	198
Stoppers, Glass, Flat head, ASTM, Clear	8500	154, 179	TEST TUBES		
Stoppers, Glass, Flathead, ASTM, Amber	8700	154, 179	Test Tube, With Rim	9800	192
SINTERED WARE			Tube for culture collection	9801	192
Buchner Funnel With Sintered Disc	36060	202	Test Tube, Without Rim	9820	193
Gooch Crucible Low Form, With Sintered Disc	32060	203	Test Tube, Flat bottom, Without Rim	9821	193
Tube for Gooch Crucible	32061	203	Test Tube, Flat bottom, With Rim	9822	194
SOCKETS			Test Tube, Plain, With I/C Stopper	9829	194
Sockets, Plain shank, Single	6580	161	Test Tube, Graduated, With I/C Stopper	9830	194
Sockets, Plain shank, Double	6581	161	Test Tube, Graduated, With I/C Stopper, Amber	9831	195
STIRRER ROD			COD Digestion Tube	9835	195
Stirrer Rod, Glass	9850	196	Methylene Blue reduction test tube	9837	195
Stirrer Rod, Glass, With PTFE Blade	9860	196			

V

	Cat No.	Page No.
VISCOMETER		
Viscometer college pattern	3500	97
VOLUMETRIC FLASKS		
Volumetric Flask, Class A, Narrow mouth, Clear	5640	144
Volumetric Flask, Class B, Narrow mouth, Clear	5641	144
Volumetric Flask, Class A, Wide mouth, Clear	5643	145
Volumetric Flask, ASTM, Narrow mouth, Clear	5645	145
Volumetric Flask, USP, Class A, Narrow mouth, Clear	5645D	146
Volumetric Flask, ASTM, Wide mouth, Clear	5647	146
Volumetric Flask, USP, Class A, Wide mouth, Clear	5647D	147
Volumetric Flask, Class A, Narrow mouth, Amber	5648	147
Volumetric Flask, Class B, Narrow mouth, Amber	5649	148
Volumetric Flask, Sugar Estimation	5650	148
Petroleum Jar	5639	148
Volumetric Flask, Class A, Wide mouth, Amber	5653	149
Volumetric Flask, ASTM, Narrow mouth, Amber	5655	149
Volumetric Flask, USP, Class A, Narrow mouth, Amber	5655D	150
Volumetric Flask, ASTM, Wide mouth, Amber	5657	150
Volumetric Flask, USP, Class A, Wide mouth, Amber	5657D	151
VIALS & CLOSURES		
2 ml HPLC Sample Vials & Closures		227
2 ml HPLC Sample Vials & Closures		
49 Expansion glass vial with silicone white / PTFE red septa	228-229	
2 ml HPLC Sample Vials & Closures		
33 Expansion glass vial with silicone white / PTFE red septa	230-231	
20 ml GC Headspace Vials & Closures		232
40 ml EPA/TOC Combipack		233
W		
WATER DISTILLATION UNITS		
On Demand Single Distillation Unit		91,290
On Demand Double Distillation Unit		92,291
On Demand All Quartz Distillation Unit		294
Quartz Cabinet Distillation		93,292
Mono Quartz Distillation Unit		94,293
All Quartz Double Distillation Unit		95,294
Silicone Tubing for distillation unit		91
WEIGHING SCOOP	7200	176
WATCH GLASS	9986	199
TECHNICAL INFORMATION		408-414

Caution Notice

BOROSIL SCIENTIFIC LIMITED a company registered under the Companies Act, 1956 and having its registered office at 1101, Crescenzo, G-Block, Opp. MCA Club, Bandra Kurla Complex, Bandra (East), Mumbai - 400 051, Maharashtra, India is the licensee of trademark BOROSIL, which is a registered mark. The said, trademark **BOROSIL®** has been used in the market for selling and exporting a wide variety of glassware products for more than 5 (five) decades throughout India as well as several countries across the globe.

The trademark **BOROSIL®** has acquired a very high reputation and goodwill by virtue of long, extensive and continuous use. The said trademark is associated and identified exclusively with the Scientific and Industrial Products which are manufactured, marketed and sold by **BOROSIL SCIENTIFIC LIMITED (BSL)**.

It has, come to our notice that some unscrupulous persons are attempting to sell counterfeit products by unlawfully copying the trademark **BOROSIL®** and/or 'Borosil Logo'

The trade and public are cautioned that only products manufactured, marketed and sold by **BSL** are permitted to carry the trademark **BOROSIL®** or 'Borosil Logo'.

Those who are deceiving the public by copying the trademark **BOROSIL®** or 'Borosil Logo' or using it wrongly on products not made, marketed and /or sold by BSL will be prosecuted and we will adopt all legal recourse available, including civil and/or criminal proceedings and may include police raids, to prevent such infringement/unauthorized use without giving further notice.

The trade and public are cautioned that they should always purchase only from our authorised sources, request for a GST invoice on purchase of the **BOROSIL®** products, as spurious goods are of inferior quality which will not give the user the desired results.

We request you to immediately bring to our attention any instances of suspected counterfeit products, which you may come across, and your identity shall be kept strictly confidential.

For any queries or to report unauthorised activities, please contact us at our registered office address of as mentioned above and write to us at bsl@borosil.com

NOTES

A large area of the page is filled with horizontal dotted lines, providing a space for handwritten notes.

Please contact CT Enterprises for quotation.
Email: sales@ctenterprises.in | Phone: +91 8977721310

NOTES

A large area of the page is filled with horizontal dotted lines, providing a space for handwritten notes.

Please contact CT Enterprises for quotation.
Email: sales@ctenterprises.in | Phone: +91 8977721310

BOROSIL[®] Scientific

Borosil Scientific Limited

PERIODIC TABLE OF THE ELEMENTS

1	2	3	4	5	6	7	8	9	10	11	12	13	14	15	16	17	18											
H HYDROGEN 1.008 [1.0079, 1.0082]	He HELIUM 4.0026	Li LITHIUM 6.94 [6.938, 6.997]	Be BERYLLIUM 9.0122	B BORON 10.81 [10.806, 10.821]	C CARBON 12.011 [12.008, 14.008]	N NITROGEN 14.007 [14.006, 14.008]	O OXYGEN 15.999 [15.999, 16.000]	F FLUORINE 18.998	Ne NEON 20.180	Na SODIUM 22.990	Mg MAGNESIUM 24.304 [24.304, 24.307]	Al ALUMINIUM 26.982	Si SILICON 28.084 [28.084, 28.086]	P PHOSPHORUS 30.974	S SULPHUR 32.06 [32.059, 32.076]	Cl CHLORINE 35.45 [35.446, 35.457]	Ar ARGON 39.948 [39.792, 39.963]											
K POTASSIUM 39.098	Rb RUBIDIUM 85.468	Ca CALCIUM 40.078 (4)	Sc SCANDIUM 44.956	Ti TITANIUM 47.887	V VANADIUM 50.942	Cr CHROMIUM 51.996	Mn MANGANESE 54.938	Fe IRON 55.845 (2)	Ni NICKEL 58.693	Cu COPPER 63.546 (3)	Zn ZINC 65.38 (2)	Ga GALLIUM 69.723	Ge GERMANIUM 72.630 (6)	As ARSENIC 74.922	Se SELENIUM 78.971 (6)	Kr KRYPTON 83.796 (2)												
Fr FRANCIUM	Ra RADIUM	Sr STRONTIUM 87.62	Y YTRIUM 88.906	Zr ZIRCONIUM 91.224 (2)	Nb NIOBIUM 92.906	Mo MOLYBDENUM 95.95	Tc TECHNETIUM	Ru RUTHENIUM 101.07 (2)	Pd PALLADIUM 106.42	Ag SILVER 107.87	Cd CADMIUM 112.41	In INDIUM 114.82	Sn TIN 118.71	Sb ANTIMONY 121.76	Te TELLURIUM 127.60 (3)	Xe XENON 131.29												
Cs CAESIUM 132.91	Ba BARIUM 137.33	Sr STRONTIUM 87.62	Y YTRIUM 88.906	Zr ZIRCONIUM 91.224 (2)	Nb NIOBIUM 92.906	Mo MOLYBDENUM 95.95	Tc TECHNETIUM	Ru RUTHENIUM 101.07 (2)	Pd PALLADIUM 106.42	Ag SILVER 107.87	Cd CADMIUM 112.41	In INDIUM 114.82	Sn TIN 118.71	Sb ANTIMONY 121.76	Te TELLURIUM 127.60 (3)	Xe XENON 131.29												
La LANTHANUM 138.91	Ce CERIUM 140.12	Pr PRASEODYMIUM 140.91	Nd NEODYMIUM 144.24	Pm PROMETHIUM	Sm SAMARIUM 150.36 (2)	Eu EUROPIUM 151.96	Gd GADOLINIUM 157.25 (3)	Tb TERBIUM 158.93	Dy DYSPROSIUM 162.50	Ho HOLMIUM 164.93	Tm THULIUM 168.93	Yb YTTERIUM 173.05	Lu LUTETIUM 174.97	Ac ACTINIUM 227.03	Th THORIUM 232.04	Pa PROTACTINIUM 232.04	U URANIUM 238.03	Np NEPTUNIUM	Pu PLUTONIUM	Am AMERICIUM	Cm CURIUM	Bk BERKELIUM	Cf CALIFORNIUM	Es EINSTEINIUM	Fm FERMIUM	Md MENDELEVIUM	No NOBELIUM	Lr LAWRENCIUM

1 — ATOMIC NUMBER
 H — SYMBOL
 HYDROGEN — NAME
 1.008 — CONVENTIONAL STANDARD WEIGHT
 [1.0079, 1.0082] — ATOMIC WEIGHT

Did you know?
 Dmitry Mendeleev discovered the periodic system 150 years ago. To commemorate this, 2019 has been proclaimed the International Year of the Periodic Table of Chemical Elements.

Laboratory Glassware : <https://www.borosilab.com>
 Laboratory Equipment : <https://labquest.co>
 Filter Papers : <https://borosilfilters.com>

BOROSIL[®] Scientific

Borosil Scientific Limited

Visit
Website



Follow us on
LinkedIn



CIN : U74999MH1991PLC061851

Registered & Corporate Office :

1101, Crescenzo, G-Block, Opp. MCA Club, Bandra Kurla Complex,
Bandra (E), Mumbai - 400 051, India.

T +91 22 6740 6300 • F +91 22 6740 6514
E bsl@borosil.com • W www.borosilscientific.com

Write to us for export enquiries at bsl.exports@borosil.com

MUMBAI

B-306, Kanakia Zillion,
L.B.S. Marg, Kurla (West),
Mumbai - 400 070

mumbaisales@borosil.com

+91 22 6740 6400
+91 22 6740 6444

DELHI

1213 Vijaya Building 17
Barakhamba Road
New Delhi - 110001

delhi@borosil.com

+91 11 4150 5893

CHENNAI

Golden Perch,
No 7, 3rd Floor,
No. 3 Wheat Crofts Road,
Nungambakkam,
Chennai - 600 034

chennai@borosil.com

+91 44 2822 6012 / 13
+91 44 2822 6014

KOLKATA

E-2/3 Gillander House,
2nd Floor, FL- E- 2/3,
8 Netaji Subhas Road,
Kolkata- 700001

calcutta@borosil.com

+91 33 2229 9166

Multi-Port
HPLC Cap
with Anti-twist
mechanism

A smart solution
for transfer of
HPLC mobile
phase solvents



World's Finest
Quality
Filter Paper

Hahnemühle
Filter Paper



For Labs
where
compliance
matters



Filtration
Products



ISO

ISO

ISO

ISO

ISO

Please contact CT Enterprises for quotation.

Email: sales@ctenterprises.in | Phone: +91 8977721310